

catalogo LISTINO 31



40° anniversary



 **stilhaus**[®]
ARREDO | BAGNO

40° anniversary



L'AZIENDA

Stilhaus dal 1978 propone soluzioni d'arredo per il bagno grazie ai progetti di affermati designers e all'abile esperienza dei collaboratori che lavorano artigianalmente per realizzare prodotti di qualità.

Gli arredamenti Stilhaus nascono come NECESSARI PER IL BAGNO: lo specchio, l'applique, il porta scopino o il porta rotolo, sono elementi fondamentali nella stanza del benessere e, grazie alla varietà dell'offerta, permettono sia la realizzazione che la valorizzazione dei progetti proposti dal venditore per la soddisfazione del cliente. Il Made in Italy di Stilhaus è un pregio che nasce non solo dal territorio ma dalla creatività e dalle capacità individuali connesse ad un indotto di aziende italiane affidabili e consolidate.



necessari  per il bagno

8 MOTIVI PER COLLABORARE CON NOI:

- Ampia gamma di articoli
- Un catalogo listino di facile utilizzo
- Produzione italiana
- Esperienza dei collaboratori
- Rapidità e flessibilità nelle consegne
- Personalizzazione degli articoli
- Consulenza tecnica
- Qualità garantita 5 anni

Questo catalogo vuole essere un utile strumento di vendita esprimendo concretezza ed efficienza aziendale.



THE FACTORY / L'ENTREPRISE

DAS UNTERNEHMEN / ЧТО КОМПАНИЯ

STILHAUS since 1978 offers furniture solutions for the bathroom by combining the inventiveness of established designers with solid experience of employees to achieve products of good quality.

The Stilhaus Bathroom born as NECESSARY FOR THE BATHROOM, the mirror, the lamps, the toilet brush, the paper holder are fundamental elements for the wellness room and allow the realisation and exploitation of projects proposed by seller for the customer satisfaction.

Stilhaus products guarantee national origin, our products are manufactured inside our structure that is connected to an armature of Italian companies.

Eight reasons to work with us:

- Wide range of items
- A catalogue/price list easy to use
- Italian production
- Collaborators experience
- A fast delivery service
- Item Customization
- Technical advice
- A 5 year quality guarantee

We hope that this catalogue reflects our dedication and efficiency and you find what you are looking for.

STILHAUS depuis 1978 propose des solutions pour la salle de bains en combinant l'inventivité des designers établis avec une solide expérience des employés pour fabriquer des produits de qualité

Les Stilhaus accessoires nés au NÉCESSAIRES POUR LA SALLE DE BAIN: le miroir, l'applique, le porte balayent, le porte rotuleau, sont des éléments fondamentaux dans la salle de bien-etre et permettent la réalisation et l'exploitation des projets proposés par le vendeur pour la satisfaction de la clientèle.

Les produits de la Stilhaus sont fabriqués à l'intérieur de notre structure qui est connecté à une armature de sociétés italiennes.

Huit raisons de travailler avec nous :

- Une large gamme d'articles
- Un catalogue /list de prix facile à utiliser
- Production italienne
- Expérience des employés
- La vitesse et la flexibilité des livraisons
- La personnalisation des articles
- Conseils techniques
- Qualité garantie 5 ans

Nous espérons que ce catalogue, expression de notre efficacité, puisse être pour vous un utile instrument de vente.

Seit 1978 bietet STILHAUS Lösungen für Badmöbel, die durch die Kombination von Ideenreichtum etablierter Designer mit solider Erfahrung unserer Mitarbeiter, Produkte von guter Qualität und Funktionalität zu einem günstigen Preis erzielen.

Das Zubehör von Stilhaus ist UNABDINGBAR FÜR JEDES BADEZIMMER: Spiegel, Leuchte, WC-Bürstengarnitur und WC-Papierhalter sind fundamentale Elemente für einen Raum des Wohlbefindens und dank der Vielfalt des Angebots erlauben sie die Realisation der Projekte, die vom Verkäufer zur Zufriedenheit des Kunden vorgeschlagen werden.

Alle Produkte von Stilhaus sind garantiert italienischer Herkunft.

Acht Gründe, mit uns zu arbeiten:

- Große Auswahl an Artikeln
- Einfach zu bedienende Preisliste/ Katalog
- Italienische Produktion
- Erfahrung der Beteiligten
- Geschwindigkeit und Flexibilität bei der Lieferung
- Produktpassung
- Technische Beratung
- 5 Jahre Qualitätsgarantie

Wir hoffen, dass dieser Katalog unsere Effizienz und Hingabe reflektiert, und dass Sie finden, wonach Sie suchen.

Фабрика STILHAUS является семейным предприятием, начиная с 1978 года, фабрика предлагает различные решения для ванной комнаты, объединив изобретательность авторитетных дизайнеров с опытом своих сотрудников, что бы получить в итоге эстетику и функциональность по разумной цене. Продукция Stil Haus предлагает важнейшие предметы необходимости для ванной комнаты: зеркала, бра, бумагодержатели, ерши и т.д. Благодаря разнообразию производимых изделий у покупателя всегда есть выбор понравившихся ему позиций. Made in Italy – это бесспорно важный аргумент не только по национальному происхождению, но и творчеству и индивидуальным возможностям изготовления. Изделия фабрики Stil Haus гарантируют итальянское происхождение. Они изготовлены из высококачественных материалов итальянского производства и проходят процедуры, которые гарантируют стойкость к коррозии и долговечность.

Основные преимущества фабрики Stil Haus:

- Изготовление 100 % в Италии.
- Изготовление позиций под заказ.
- Широкий выбор аксессуаров для ванной комнаты.
- Скорость и гибкость в доставке.
- Технический сервис.
- Приемлемая цена в сочетании с итальянским качеством.
- Гарантия качества 5 лет.

Этот каталог будет полезным инструментом продаж для вас.

DESIGNER OF COLLECTIONS

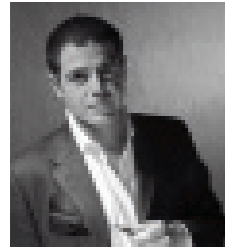

CLAUDIO PAPA

Collections: ZEFIRO, QUID, LIQUID, SOLID

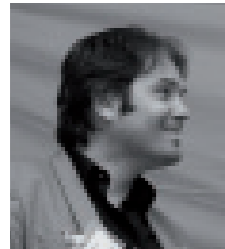

MASSIMILIANO SETTIMELLI

Collections: ARIA, FLUID, DIVA, COMODO, LUI & LEI, TETRIS, PEONIA, OPERA, LIZ



ALESSANDRO LENARDA

Collections: MURANO'S APPOGGI E LAVABI IN CRISTALLO PURO



GIANLUCA PALUDI

Collections: HASHI, ECO



BGR INDUSTRIAL DESIGN

Collections: LIVING



GIOVANNA TALOCCI

Collections: BUCKET



PAOLO GALLETTI E DANIELE MALTINTI

Collections: KREA

CERTIFICAZIONI E GARANZIA



I nostri prodotti sono realizzati con materiali di prima qualità e produzione italiana e sono sottoposti a trattamenti che ne garantiscono la resistenza alla corrosione e la durata nel tempo.

Un accurato controllo e verifica dell'assemblaggio, forte della nostra lunga esperienza, permettono di dare a questi prodotti una garanzia di 5 anni dalla data di acquisto, comprovata da un documento fiscale rilasciato dal negoziante.

Sono esclusi tutti i difetti derivanti da uso ed installazione impropri, errati o successivi interventi sul prodotto non autorizzati.



CERTIFICATIONS AND GUARANTEE CERTIFICATIONS ET GARANTIE ZERTIFIZIERUNGEN UND GARANTIEBESTIMMUNGEN СЕРТИФИКАЦИЯ И ГАРАНТИЯ

Our products are created using materials of the highest quality made in Italy. They undergo treatments which guarantee their resistance to corrosion and their durability. Our products undergo rigorous controls and tests during production enabling us to guarantee our products for 5 years from the date of purchase. This guarantee will be validated by a receipt or proof of purchase. The guarantee does not cover any damage due to incorrect installation or any other work carried out by unauthorised persons.

Nos produits sont réalisés avec des matériaux de première qualité et production Italienne et sont soumis à des traitements qui garantissent la résistance à la corrosion et la durabilité dans le temps. Un contrôle particulièrement soigné lors de l'assemblage et nos trente ans d'expérience nous permettent de donner à nos produits 5 ans de garantie à partir de la date d'achat qui est prouvée par un document (ticket de caisse ect) livré par le marchand. Sont exclus tous les défauts dérivant d'une mauvaise utilisation ou installation du produit ou dérivant de successives interventions non autorisées sur le produit.

Unsere Produkte wurden ausschließlich aus erstklassigen Materialien in Italien hergestellt und speziellen Verfahren unterzogen, die Dauerhaftigkeit und Widerstandsfähigkeit garantieren. Die genaue Kontrolle und Überprüfung der Produktion ist die Stärke in unserer 30-jährigen Erfahrung, die uns erlauben auf unsere Produkte 5 Jahre Garantie ab Kaufdatum (Rechnungsbeleg) zu gewähren. Ausgenommen sind Mängel die durch falsche Nutzung, fehlerhaften Einbau oder nachträgliche, nicht autorisierte Veränderungen am Produkt entstehen.

Наша продукция изготавливается из качественных материалов и подвергается различным обработкам, которые обеспечивают коррозионную стойкость и долговечность изделия. Тщательный контроль качества и сборка, многолетний опыт сотрудников, позволяют дать гарантию на продукцию 5 лет с даты покупки, о чем свидетельствует документ выданный для розничной торговли. Все дефекты, возникшие в результате неправильного использования или установки не рассматриваются.

STILHAUS è... Necessari per il bagno

collezioni moderne



Modern / Moderne / Modern / современный стиль

collezioni classiche



Classic / Classique / klassisch / классический стиль

oggettistica



complementi

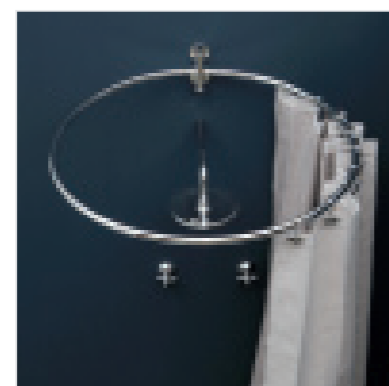

hotellerie

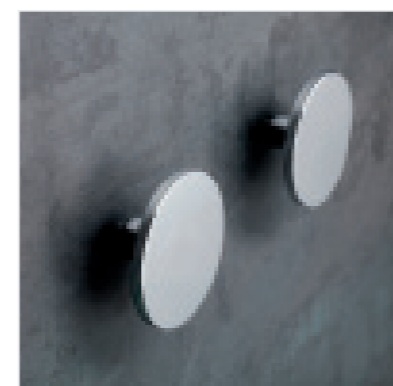

Accessories set / Set accessoires / Zubehör sets / Настольные предметы

Accessories / Accessoires / Zubehör / Дополнительные предметы

Hotellerie / Hôtellerie / Hotellerie / Для гостиниц и ресторанов

soluzioni arredo



termoarredi



illuminazione

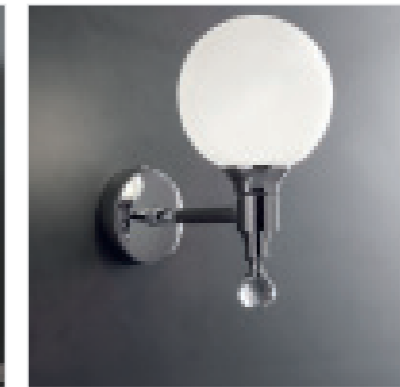

Solutions / Solutions / Lösungen / Мебельные решения

Brass wall towel warmer / sèche-serviettes / Warmwasser-Wandhandtuchwärmer / полотенцесушители

Lighting / Éclairage / Beleuchtung / освещение

specchi / mirror / miroirs / spiegel / зеркала

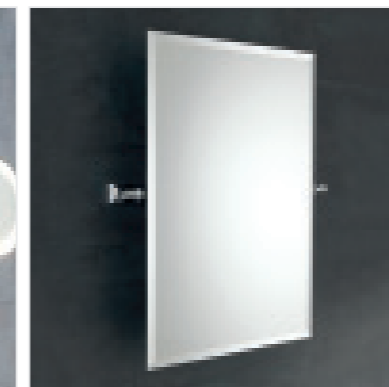

senza illuminazione
without lighting
sans éclairage
ohne Beleuchtung
Зеркала без подсветки

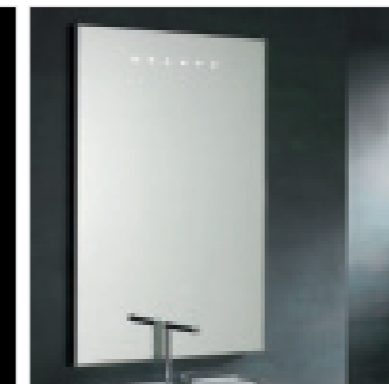
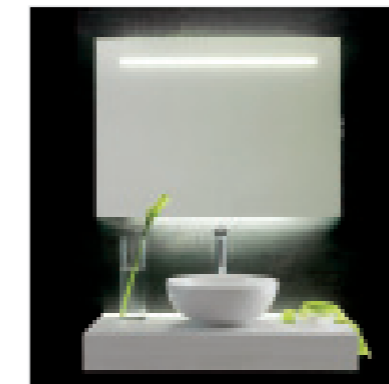

retroilluminati o combinati con illuminazione perimetrale
backlit or combined with perimeter lighting
rétro-éclairé ou combiné avec un éclairage périmétrique
LED-Hinterlicht oder LED seitlich
Зеркала с подсветкой или с подсветкой по периметру

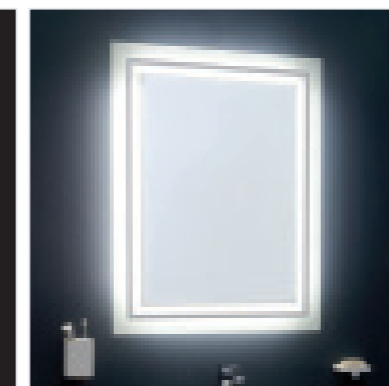
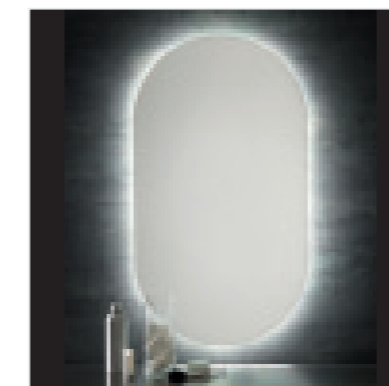

Con illuminazione perimetrale
with perimeter lighting
avec un éclairage périmétrique
mit LED seitlich
Зеркала с подсветкой по периметру

ARIA



PAG_12

BUCKET



PAG_18

DIANA



PAG_24



DIVA



PAG_30



FLUID



PAG_38

GEA



PAG_44

HASHI



PAG_52

KREA



PAG_58

LIZ



PAG_68



LIVING



PAG_77

MEDEA



PAG_82



MIZAR



PAG_90

QUID



PAG_96



SATURNO



PAG_104

URANIA



PAG_110



VENUS



PAG_118



ZEFIRO



PAG_126

ELITE



PAG_132



GIUNONE



PAG_140

IDRA



PAG_148



MARTE



PAG_156

NEMI



PAG_162



NOTO



PAG_170

NOTO LIGHT



PAG_176

OPERA



PAG_182



PRISMA



PAG_188

SMART



PAG_196

SMART LIGHT



PAG_202

SOLUZIONI



PAG_208

SPECCHI



PAG_226

ILLUMINAZIONE



PAG_276

TERMOARREDI



PAG_300

PLACCHE



PAG_306

PIANTANE



PAG_308

OGGETTISTICA



PAG_332

ARREDO



PAG_350

SCOPINI



PAG_356

DOCCIA

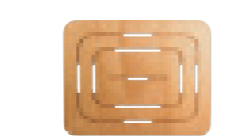

PAG_364

GRIGLIE



PAG_380

MENSOLE

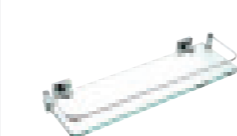

PAG_388

SGABELLI



PAG_390

HOTELLERIE



PAG_394

PAG_6 **Designers** Designers / Designers / Designers / дизайнерыPAG_404 **Ricambi** Spare parts / Pièces de rechange / Ersatzteile / запчастиPAG_409 **Espositori** Exhibitors / Exposants / Ausstellungsstände / ЭкспозиторыPAG_412 **Condizioni di vendita** Terms of sale / Conditions de vente / Verkaufsbedingungen / условия продажиPAG_415 **Tabella colori** Spare parts / Pièces de rechange / Ersatzteile / Таблица цветов

Schiaccia pensieri



ARIA

Designer: Massimiliano Settimelli
Materiale: Barra Ovale - 40x20
Accessori: Ceramica
Finitura: 08
Fuori misura: Si

Designer: Massimiliano Settimelli
Material: Oval Brass Bar - cm 40x20
Accessories: Ceramic
Finishes: 08
Customized: Yes

Designer: Massimiliano Settimelli
Matériel: Laiton massif Bar Ovale - 40x20
Accessoires: céramique
Finitions: 08
Personnalisé: Oui

Designer: Massimiliano Settimelli
Material: Messing oval bar - 40x20
Zubehör: Keramik
Ausführungen: 08
Kundenwunsch: Ja

Дизайн: Massimiliano Settimelli
Материал: латунь, овальная
форма - 40x20
Аксессуары: керамика
Отделка: 08 хром
Негабаритный: да



AR 11
AR 039 M

AR 14



AR 16



AR 45

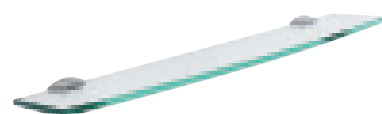

AR 04

Mensola vetro 8 mm
Shelf
Étagère
Ablage
Стеклоянная полка – толщина стекла 8 мм
cm 60 L x 13 P x 2 H

•08



AR 05

Asta porta asciugamani
Towel rail
Porte serviettes
Handtuchhalter
Полотенцедержатель
cm 56 L x 7,5 P x 2 H - INT. 49

•08



AR 45

Asta porta asciugamani
Towel rail
Porte serviettes
Handtuchhalter
Полотенцедержатель
cm 45 L x 7,5 P x 2 H - INT. 39

•08



AR 06

Asta porta salviette
Towel rail
Porte serviettes
Handtuchhalter
Полотенцедержатель
cm 30 L x 7,5 P x 2 H - INT. 23

•08



AR 11

Porta rotolo
Paper holder
Porte rouleau
Papierrollenhalter
Бумагодержатель
cm 18 L x 7,5 P x 2 H

•08



AR 11 C

Porta rotolo con coperchio
Covered paper holder
Porte rouleau avec couvercle
Papierrollenhalter mit Deckel
Бумагодержатель с крышкой
cm 13 L x 13 P x 10 H

•08



AR 039

Porta scopino ovale
Toilet-brush
Porte balayent d'appui
Bürstengarnitur freistehend
Напольный металлический ёрш
cm 10 L x 6,5 P x 47 H

•08



AR 039 M

Porta scopino a parete
Wall mounted toilet-brush
Porte balayent à mur
Bürstengarnitur wandhängend
Настенный металлический ёрш
cm 10 L x 7,5 P x 47 H

•08



AR 16

Porta asciugamani a snodo 2 aste
Towel rail with 2 adjustable bar
Porte serviettes à 2 barres orientables
Handtuchhalter schwenkbar 2 Stangen
Полотенцедержатель двойной поворотный
cm 34 L x 2,5 P x 8,5 H

•08



AR 07

Anello porta salviette
Ring serviette holder
Porte serviettes à anneau
Handtuchring
Полотенцедержатель – полукольцо
cm 30 L x 7,5 P x 14,5 H

•08



AR 09

Porta sapone a parete
Wall mounted soap dish
Porte savon à mur
Seifenschale wandhängend
Настенная керамическая мыльница
cm 18 L x 11 P x 4 H

•08 bianco / white / blanc / weiße / белый

•08 nero / black / noir / schwarz / черный

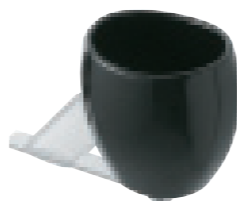

AR 10

Porta bicchiere a parete
Wall mounted glass holder
Porte verre à mur
Zahnbürstenhalter wandhängend
Настенный керамический стакан
cm 16 L x 10 P x 13 H

•08 bianco / white / blanc / weiße / белый

•08 nero / black / noir / schwarz / черный



AR 945

Porta scopino in ceramica
Ceramic Toilet-brush
Porte balayent en ceramique
Bürstengarnitur wandhängend
Напольный керамический ёрш
cm 13 L x 9 P x 46 H

•08 bianco / white / blanc / weiße / белый

•08 nero / black / noir / schwarz / черный



652

Porta sapone da appoggio
Soap dish with base
Porte savon d'appui
Seifenschale freistehend
Настольная керамическая мыльница
cm 13 L x 8 P x 2 H

•08 bianco / white / blanc / weiße / белый

•08 nero / black / noir / schwarz / черный



653

Bicchiere da appoggio
Glass with base
Verre d'appui
Zahnputzbecher freistehend
Настольный керамический стакан
cm 10 L x 7 P x 10 H

•08 bianco / white / blanc / weiße / белый

•08 nero / black / noir / schwarz / черный

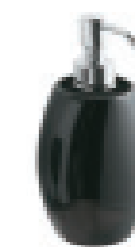

654

Dosatore sapone d'appoggio
Soap dispenser with base
Porte savon d'appui
Seifenspender freistehend
Настольный керамический дозатор
cm 10 L x 7 P x 19 H

•08 bianco / white / blanc / weiße / белый

•08 nero / black / noir / schwarz / черный



AR 30

Dosatore sapone liquido a parete
Wall mounted soap dispenser
Doseur de savon à mur
Seifenspender wandhängend
Настенный керамический дозатор
cm 16 L x 10 P x 21 H

•08 bianco / white / blanc / weiße / белый

•08 nero / black / noir / schwarz / черный

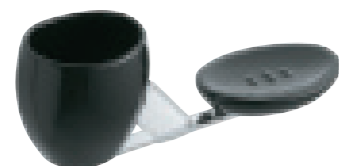

AR 14

Porta sapone e porta bicchiere a parete
Wall mounted soap dish and tumbler
Porte savon et porte verre à mur
Seifenschale und Zahnbürstenhalter wandhängend
Настенные керамические мыльница + стакан
cm 28 L x 11 P x 13 H

•08 bianco / white / blanc / weiße / белый

•08 nero / black / noir / schwarz / черный



AR 13

Porta accappatoio (2 ganci)
Robe hook (2 hooks)
Porte peignoir (2 crochets)
Bademantelhaken (2 Haken)
Крючок двойной
cm 10 L x 7,5 P x 2 H

•08



AR 13.1

Porta accappatoio
Robe hook
Porte peignoir
Bademantelhaken
Крючок
cm 2 L x 5 P x 4 H

•08

FINITURA

08-BI



CROMO - CER. BIANCO
Chrome - Cer. white
Chrome - Cér. blanc
Chrom - Ker. weiße
хром - белая керамика

08-NE



CROMO - CER. NERO
Chrome - Cer. black
Chrome - Cér. noir
Chrom - Ker. schwarz
хром - черная керамика



Su richiesta si realizzano aste porta asciugamani su misura, 20 gg

Customized towel rails are available on request, 20 days
Des porte-serviettes personnalisés sont disponibles sur demande, 20 jours
Handtuchhalter sind auf Anfrage erhältlich, 20 Tagen

По запросу мы можем производить полотенцедержатели под размер 20 дней



•08 25 → 44 cm

•08 46 → 100 cm

Il peso della creatività



BUCKET

Designer: Giovanna Talocci
Materiale: Piatto ottone 25x4
Accessori: ceramica bianca
Finiture: 08
Fuori misura: No

Designer: Giovanna Talocci
Material: Solid Brass Bar 25x4
Accessories: white ceramic
Finishes: 08
Customized: No

Designer: Giovanna Talocci
Matériel: laiton massif Bar 25x4
Accessoires: blanc céramique
Finitions: 08
Personnalisé: No

Designer: Giovanna Talocci
Material: aus massivem Messing Bar 25x4
Zubehör: weiße Keramik
Ausführungen: 08
Kundenwunsch: Nein

Дизайн: Giovanna Talocci
Материал: латунь
Аксессуары: белая керамика
Отделка: 08 хром
Негабаритный: нет

BK 45



BK 11



BK 13



BK 14

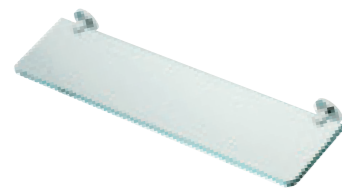

BK 04

Mensola vetro
Shelf
Étagère
Ablage
Стеклоянная полка
cm 60 L x 12 P x 5 H

• 08



BK 05

Asta porta asciugamani
Towel rail
Porte serviettes
Handtuchhalter
Полотенцедержатель
cm 56,5 L x 4 P x 3 H - INT. 54

• 08



BK 45

Asta porta asciugamani
Towel rail
Porte serviettes
Handtuchhalter
Полотенцедержатель
cm 45 L x 4 P x 3 H - INT. 43

• 08



BK 06

Asta porta salviette
Towel rail
Porte serviettes
Handtuchhalter
Полотенцедержатель
cm 34 L x 4 P x 3 H

• 08



BK 13

Porta accappatoio
Robe hook
Porte peignoir
Bademantelhaken
Крючок
cm 3 L x 4,5 P x 12 H

• 08



BK 11

Porta rotolo
Paper holder
Porte rouleau
Papierrollenhalter
Бумагодержатель
cm 20 L x 6 P x 3 H

• 08



BK 12 A

Porta scopino in ceramica
Ceramic Toilet-brush
Porte balayent en ceramique
Bürstengarnitur freisehend
Напольный керамический ёрш
cm Ø 10 x 42 H

• 08



BK 039 M

Porta scopino a parete
Wall mounted toilet-brush
Porte balayent à mur
Bürstengarnitur wandhängend
Настенный металлический ёрш
cm Ø 8 x 44 H

• 08



BK 07

Anello porta salviette
Ring serviette holder
Porte serviettes à anneau
Handtuchring
Полотенцедержатель - кольцо
cm 23 L x 7 P x 33 H

• 08

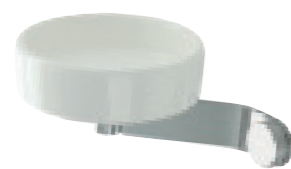

BK 09

Porta sapone a parete
Wall mounted soap dish
Porte savon à mur
Seifenschale wandhängend
Настенная керамическая мыльница
cm 17 L x 12 P x 6 H

• 08



BK 10

Porta bicchiere a parete
Wall mounted glass holder
Porte verre à mur
Zahnbürstenhalter wandhängend
Настенный керамический стакан
cm 15 L x 10 P x 13 H

• 08



BK 30

Dosatore sapone liquido a parete
Wall mounted soap dispenser
Doseur de savon à mur
Seifenspender wandhängend
Настенный керамический дозатор
cm 16 L x 10 P x 20 H

• 08



BK 14

Porta sapone e porta bicchiere a parete
Wall mounted soap dish and tumbler
Porte savon et porte verre à mur
Seifenschale und Zahnbürstenhalter wandhängend
Настенные керамические мыльница + стакан
cm 30 L x 12 P x 13 H

• 08



BK 09 AP

Porta sapone da appoggio
Soap dish with base
Porte savon d'appui
Seifenschale freistehend
Настольная керамическая мыльница
cm Ø 12 x 3,5 H

• 08



BK 10 AP

Bicchiere da appoggio
Glass with base
Verre d'appui
Zahnputzbecher freistehend
Настольный керамический стакан
cm Ø 9 x 10 H

• 08



BK 30 AP

Dosatore sapone d'appoggio
Soap dispenser with base
Porte savon d'appui
Seifenspender freistehend
Настольный керамический дозатор
cm Ø 9 x 18 H

• 08

BUCKET
Designer: Giovanna Talocci



Tiro libero



DIANA

Designer: Stilhaus
Materiale: Ottone, tubo ovale 20x10,
basetta a muro 50x42
Accessori: Vetro Satinato
Finitura: 08-36
Fuori misura: Sì
Incollo : Sì

Designer: Stilhaus
Material: Brass, tube 20x10, fixing plate
cover 50x42
Accessories: Frosted glass
Finishes: 08-36
Customized: Yes
By glue : Yes

Designer: Stilhaus
Matière: Laiton, tuyau 20x10, boucle
couvre-vis 50x42
Accessoires: verre satin
Finitions: 08-36
Personnalisé: Oui
Par collage : Oui

Designer: Stilhaus
Material: Messing, Rohr 20x10,
Befestigungsplatten Oberfläche 50x42
Zubehör: Mattglas
Ausführungen: 08-36
Kundenwunsch: Ja
Kleber: Ja

Дизайн: Stilhaus
Материал: латунь
Аксессуары: сатинированное
стекло
Отделка: 08 хром, 36 никель
сатин
Негабаритный: да
Установка на клей: да

DI 06



DI 16



DI 11



DI 09
DI 10
DI 30

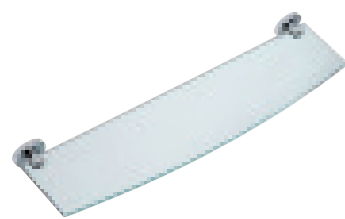

DI 04

Mensola vetro 8mm
Shelf
Étagère
Ablage
Стеклоянная полка – толщина стекла 8mm
cm 56 L x 13,5 P x 4 H

- 08
- 36



DI 05

Asta porta asciugamani
Towel rail
Porte serviettes
Handtuchhalter
Полотенцедержатель
cm 63 L x 7 P x 4 H - INT. 55

- 08
- 36



DI 45

Asta porta asciugamani
Towel rail
Porte serviettes
Handtuchhalter
Полотенцедержатель
cm 48 L x 7 P x 4 H - INT. 43

- 08
- 36



DI 06

Asta porta salviette
Towel rail
Porte serviettes
Handtuchhalter
Полотенцедержатель
cm 33 L x 7 P x 4 H - INT. 28

- 08
- 36



DI 809

Porta accappatoio (2 ganci)
Robe hook (2 hooks)
Porte peignoir (2 crochets)
Bademantelhaken (2 Haken)
Крючок
cm 5,5 L x 5,5 P x 5,5 H

- 08
- 36



DI 11

Porta rotolo
Paper holder
Porte rouleau
Papierrollenhalter
Бумагодержатель
cm 16,5 L x 7,5 P x 4 H

- 08
- 36



DI 11 C

Porta rotolo con coperchio
Covered paper holder
Porte rouleau avec couvercle
Papierrollenhalter mit Deckel
Бумагодержатель с крышкой
cm 17 L x 10 P x 9 H

- 08
- 36



DI 039 M

Porta scopino a parete
Wall-mounted toilet-brush
Porte balaynet à mur
Bürstengarnitur oval wandhängend
Настенный металлический ёрш
cm 9 L x 10 P x H 38

- 08
- 36



DI 16

Porta asciugamani snodo 2 aste
Towel rail with 2 adjustable bar
Porte serviettes à 2 barres orientables
Handtuchhalter schwenkbar 2 Stangen
Полотенцедержатель двойной поворотный
cm 3 L x 33 P x 9 H

- 08
- 36



DI 07

Anello porta salviette
Ring serviette
Porte serviettes à anneau
Handtuchring
Полотенцедержатель – кольцо
cm 22,5 Ø x 5,5 P x 24 H

- 08
- 36



DI 09

Porta sapone a parete
Wall mounted soap dish
Porte savon à mur
Seifenschale wandhängend
Настенная стеклянная мыльница
cm 13 L x 11 P x 4 H

- 08
- 36



DI 10

Porta bicchiere in vetro a parete
Wall-mounted glass holder
Porte verre à mur
Zahnbürstenhalter wandhängend
Настенный стеклянный стакан
cm 7,5 L x 11 P x 11 H

- 08
- 36



DI 039

Porta scopino da appoggio
Toilet-brush with base
Porte balaynet d'appui
Bürstengarnitur freistehend
Напольный металлический ёрш
cm 9 L x 11 P x H 38

- 08
- 36



840

Kit collante e biadesivo per un articolo
Kit with bi-adhesive and glue for one article
Kit avec collant et biadhésif pour un article
Klebekit ist ein beidseitiger Klebestreifen
Клей

- 08

FINITURA



CROMO
Chrome
Chrome
Chrom
хром

08



NICHEL SATINATO
Satin nickel
Nickel satiné
Nickel satiniert
Никель сатин

36



DI 30

Dosatore sapone liquido a parete
Wall soap dispenser
Doseur de savon à mur
Seifenspender wandhängend
Настенный стеклянный дозатор
cm 8 L x 11 P x 19 H

- 08
- 36



917

Porta sapone ovale da appoggio
Leaning oval soap dish
Porte savon ovale d'appui
Seifenschale oval freistehend
Настольная металлическая мыльница
cm 14 L x 8,5 P x 2 H

- 08



918

Bicchiere ovale da appoggio
Leaning oval glass
Verre ovale d'appui
Zahnputzbecher oval freistehend
Настольный металлический стакан
cm 5,5 L x 8 P x 11 H

- 08



919

Dosatore sapone liquido da appoggio
Leaning liquid soap dispenser
Porte savon liquid d'appui
Seifenspender freistehend
Настольный металлический дозатор
cm 5,5 L x 8 P x 16 H

- 08

 Su richiesta si realizzano aste porta asciugamani su misura, 20 gg
Customized towel rails are available on request, 20 days
Des porte-serviettes personnalisés sont disponibles sur demande, 20 jours
Handtuchhalter sind auf Anfrage erhältlich, 20 tagen
По запросу мы можем производить полотенцедержатели под размер 20 дней



- 08 25 → 47 cm
- 08 49 → 100 cm
- 36 25 → 47 cm
- 36 49 → 100 cm

Complementi / complements / compléments / ergänzungen / Дополнительно



> pag. 254



> pag. 289



> pag. 316



> pag. 316



> pag. 316



Il bello si vede, il fascino si sente



DIVA

Designer: MASSIMILIANO SETTIMELLI
Materiale: ottone, TUBO 12x12, basetta
a muro 50 x 50
Accessori: ceramica bianca
Finiture: 08
Fuori misura: Sì
Incollo: Sì

Designer: Massimiliano Settimelli
Material: Brass Bar 12x12,
fixing plate cover 50x50
Accessories: white ceramic
Finishes: 08
Customized: Yes
By glue: Yes

Designer: Massimiliano Settimelli
Matière: Laiton, tuyau 12x12, boucle
couvre-vis 50x50
Accessoires: Blanc céramique
Finitions: 08
Personnalisé: Oui
Par collage: Oui

Designer: Massimiliano Settimelli
Material: Messing Rohr 12x12,
befestigungsplatten oberfläche 50x50
Zubehör: Weiße keramik
Ausführungen: 08
Kundenwunsch: Ja
Kleber: Ja

Дизайн: Massimiliano Settimelli
Материал: латунь
Аксессуары: белая керамика
Отделка: 08 хром
Негабаритный: да
Установка на клей: да



DV 45



DV 07



DV 10
DV 30

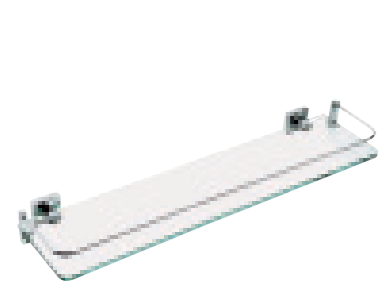

DV 04

Mensola 8 mm
Shelf
Étagère
Ablage
Стеклопанельная полка – толщина стекла 8 mm
cm 60 L x 11 P x 2 H x 50 INT

• 08



DV 05

Asta porta asciugamani
Towel rail
Porte serviettes
Handtuchhalter
полотенцедержатель
cm 61 L x 9 P x 5 H x 56,5 INT

• 08



DV 45

Asta porta asciugamani
Towel rail
Porte serviettes
Handtuchhalter
полотенцедержатель
cm 46 L x 9 P x 5 H x 41,5 INT

• 08



DV 06

Asta porta salviette
Towel rail
Porte serviettes
Handtuchhalter
Полотенцедержатель
cm 36,5 L x 9 P x 5 H x 31,5 INT

• 08



DV 69

Asta con porta sapone
Towel rail with soap dish
Porte serviettes avec porte savon
Handtuchhalter mit Seifenschale
Полотенцедержатель + керамическая мыльница
cm 40 L x 12 P x 5 H x 31,5 INT

• 08



DV 69 D

Asta con dosatore di sapone
Towel rail with liquid soap dispenser
Porte serviettes avec dosator de savon
Handtuchhalter mit Seifenspender
Полотенцедержатель + керамический дозатор
cm 60 L x 11 P x 2 H x 50 INT

• 08



DV 07

Anello porta salviette
Serviette holder to ring shaped
Porte serviettes à anneau
Handtuchring
полотенцедержатель – кольцо
cm 25 L x 6 P x 21 H

• 08

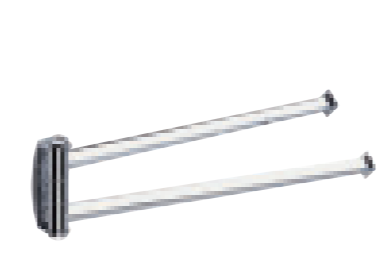

DV 16

Porta asciugamani a snodo 2 aste
Towel rail with 2 adjustable bar
Porte serviettes à 2 barres orientables
Handtuchhalter schwenkbar 2 Stangen
Полотенцедержатель двойной поворотный
cm 60 L x 11 P x 2 H x 50 INT

• 08



DV 09

Porta sapone a parete
Wall ceramic soap dish
Porte savon en céramique
Seifenschale wandhängend
Настенная керамическая мыльница
cm 13 L x 10 P x 6 H

• 08



DV 10

Porta bicchiere a parete
Wall tooth brush holder
Porte verre en céramique
Zahnbürstenhalter wandhängend
Настенный керамический стакан
cm 8 L x 10 P x 15 H

• 08



DV 30

Porta dosatore sapone liquido in ceramica
Ceramic liquid soap dispenser holder
Doseur de savon liquid en céramique
Seifenspender aus Keramik
Настенный керамический дозатор
cm 8 L x 8 P x 18 H

• 08



DV 14

Porta sapone e porta bicchiere a parete
Wall mounted soap dish and tumbler
Porte savon et porte verre à mur
Seifenschale und Zahnbürstenhalter wandhängend
Настенные керамические мыльница + стакан
cm 23 L x 10 P x 15 H

• 08



DV 11
DV 12 A





DV 09 AP

Porta sapone d'appoggio
 Soap dish
 Porte savon
 Seifenschale
 Настольная керамическая мыльница
 cm 12 L x 8 P x 2 H

•08



DV 10 AP

Bicchiera d'appoggio
 Glass
 Verre
 Zahnputzbecher
 Настольный керамический стакан
 cm 9 L x 8 P x 11,5 H

•08



DV 30 AP

Dosatore sapone liquido d'appoggio
 Liquid soap dispenser
 Porte savon liquid
 Seifenspender
 Настольный керамический дозатор
 cm 9 L x 8,5 P x 18 H

•08



DV 14

Vaschetta porta oggetti
 Tray plateau tablet
 Tablet
 Tablet
 Настольный керамический лоток
 cm 20 L x 10 P x 2 H

•08



DV 13

Porta accappatoio
 Robe hook
 Porte peignoir
 Bademantelhaken
 Крючок
 cm 5 L x 6 P x 5 H

•08



DV 11

Porta rotolo
 Paper holder
 Porte rouleau
 Papierrollenhalter
 Бумагодержатель
 cm 18 L x 9 P x 5 H

•08



DV 11C

Porta rotolo con coperchio
 Covered paper holder
 Porte rouleau avec couvercle
 Papierrollenhalter mit Deckel
 Бумагодержатель с крышкой
 cm 13 L x 14 P x 12 H

•08



DV 11S

Porta rotolo scorta
 Paper holder of supply
 Porte rouleau s'escorte
 Ersatzpapierrollenhalter
 Настенный вертикальный бумагодержатель
 cm 5 L x 9 P x 18 H

•08



DV 12 A

Porta scopino d'appoggio in ceramica
 Ceramic toilet brush
 Porte balayent en ceramique
 Bürstengarnitur freistehend aus keramik
 Настольный керамический ёрш
 cm 10 L x 10 P x 40 H

•08



DV 039 M

Porta scopino a parete
 Wall ceramic toilet brush
 Porte balayent à mur
 Bürstengarnitur wandhängend
 Настенный металлический ёрш
 cm 8 L x 8 P x 39 H

•08



DV 039

Porta scopino d'appoggio
 Ceramic toilet brush
 Porte balayent
 Bürstengarnitur freistehend
 Настольный керамический ёрш
 cm 8 L x 8 P x 39 H

•08



840

Kit collante e biadesivo per un articolo
 Kit with bi-adhesive and glue for one article
 Kit avec collant et biadhésif pour un article
 Klebekit ist ein beidseitiger Klebestreifen
 Клей

•

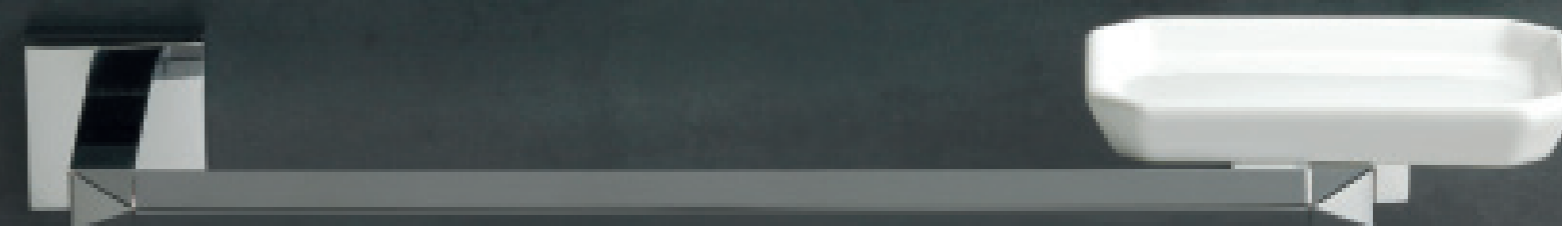

DV 69



Su richiesta si realizzano aste porta asciugamani su misura, 15 gg

Customized towel rails are available on request, 15 days
 Des porte-serviettes personnalisés sont disponibles sur demande, 15 jours
 Handtuchhalter sind auf Anfrage erhältlich, 15 tagen

По запросу мы можем производить полотенцедержатели под размер 15 дней



•08 25 → 45 cm
 •08 47 → 100 cm

Complementi / complements / compléments / ergänzungen / Дополнительно



> pag. 290

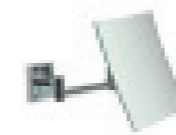

> pag. 238



> pag. 283



> pag. 381



> pag. 381



Colpo ad effetto



FLUID

Designer: Massimiliano Settimelli
Materiale: Barra ottone romboidale
25x25
Accessori: Ceramica bianca
Finitura: 08 - 09
Fuori misura: No

Designer: Massimiliano Settimelli
Material: Rhomboid Solid Brass Bar 25x25
Accessories: White ceramic
Finishes: 08 - 09
Customized: No

Designer: Massimiliano Settimelli
Matériel: Laiton massif Bar 25x25
Accessoires: Blanc céramique
Finitions: 08 - 09
Personnalisé: No

Designer: Massimiliano Settimelli
Material: Messing bar 25x25
Zubehör: weiße Keramik
Ausführungen: 08 - 09
Kundenwunsch: Nein

Дизайн: Massimiliano Settimelli
Материал: латунь
Аксессуары: белая керамика
Отделка: 08 - 09
Негабаритный: нет

FL 45

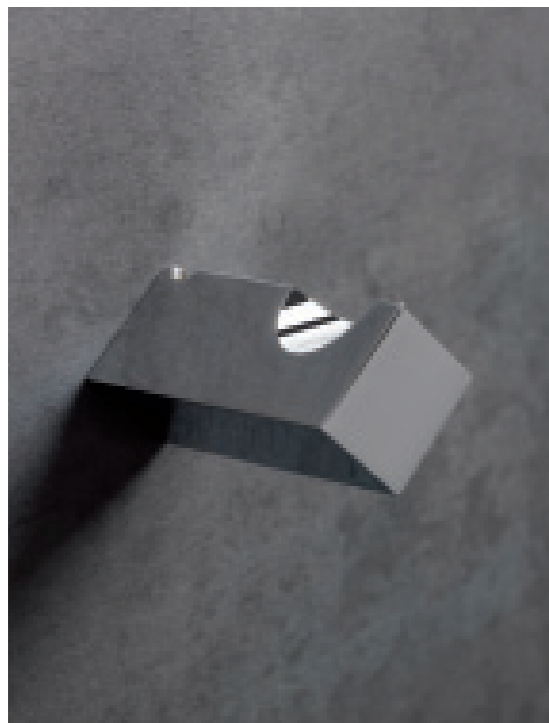

FL 13



FL 11



FL 30

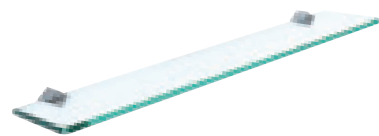

FL 04

Mensola 8 mm
Shelf
Étagère
Ablage
Стеклоянная полка – толщина стекла 8 мм
cm 60 L x 13 P x 3 H

• 08 - 09

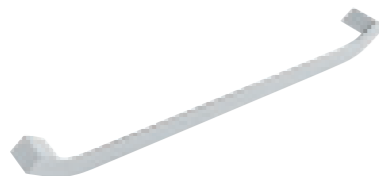

FL 05

Asta porta asciugamani
Towel rail
Porte serviettes
Handtuchhalter
Полотенцедержатель
cm 54 L x 5 P x 5 H - INT. 50

• 08 - 09

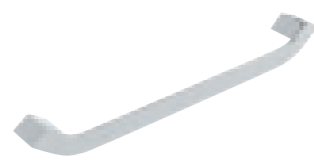

FL 45

Asta porta asciugamani
Towel rail
Porte serviettes
Handtuchhalter
Полотенцедержатель
cm 46 L x 5 P x 5 H - INT. 42

• 08 - 09



FL 06

Asta porta salviette
Towel rail
Porte serviettes
Handtuchhalter
Полотенцедержатель
cm 30 L x 5 P x 5 H

• 08 - 09



FL 11

Porta rotolo
Paper holder
Porte rouleau
Papierrollenhalter
Бумагодержатель
cm 20 L x 6 P x 5 H

• 08 - 09



FL 633

Porta scopino d'appoggio in ceramica
Ceramic toilet brush
Porte balayent en ceramique
Bürstengarnitur freistehend aus Keramik
Напольный керамический ёрш
cm 10 L x 10 P x 43 H

• 08 - 09



FL 039 M

Porta scopino a parete
Wall mounted toilet-brush
Porte balayent à mur
Bürstengarnitur wandhängend
Настенный металлический ёрш
cm 8 L x 9 P x 43 H

• 08 - 09



FL 039

Porta scopino da appoggio
Toilet-brush holder
Porte balayent d'appui
Bürstengarnitur freistehend
Напольный металлический ёрш
cm 8 L x 8 P x 43 H

• 08 - 09



FL 07

Anello porta salviette
Ring towel serviette
Porte serviettes anneau
Handtuchring
Полотенцедержатель – кольцо
cm 22,5 L x 5 P x 25 H

• 08 - 09



FL 09

Porta sapone a parete
Wall mounted soap dish
Porte savon à mur
Seifenschale wandhängend
Настенная керамическая мыльница
cm 13 L x 10 P x 5 H

• 08 - 09



FL 10

Porta bicchiere a parete
Wall mounted glass holder
Porte verre à mur
Zahnbürstenhalter wandhängend
Настенный керамический стакан
cm 8,5 L x 10 P x 15 H

• 08 - 09



FL 30

Dosatore sapone liquido a parete
Wall mounted liquid soap dispenser
Doseur de savon liquid à mur
Seifenspender wandhängend
Настенный керамический дозатор
cm 8,5 L x 10 P x 22 H

• 08 - 09

FINITURA



CROMO
Chrome
Chrom
хром

08



OTTONE NATURALE
Natural brass
Laiton naturel
Natürliches messing
Натуральная латунь

09*

★FINITURA DISPONIBILE IN 20 GG.
Finish available in 20 days
Finition disponible en 20 jours
Oberfläche lieferbar in 20 Tagen
Отделка доступна в течение 20 дней



FL 09 AP

Porta sapone d'appoggio
Soap dish
Porte savon
Seifenschale
Настольная керамическая мыльница
cm 12 L x 8 P x 2 H

• 08



FL 10 AP

Bicchiere d'appoggio
Glass
Verre
Zahnputzbecher
Настольный керамический стакан
cm 9 L x 8 P x 11,5 H

• 08



FL 30 AP

Dosatore sapone liquido d'appoggio
Liquid soap dispenser
Porte savon liquid
Seifenspender
Настольный керамический дозатор
cm 9 L x 8,5 P x 18 H

• 08 - 09



FL 13

Porta accappatoio
Robe hook
Porte peignoir
Bademantelhaken
Крючок
cm 4 L x 5 P x 3 H

• 08 - 09



FL 09
FL 10

Progetto di stile



Designer: Stilhaus
Materiale: Barra ottone pieno 30x20
Accessori: Ceramica bianca
Finiture: 08 - 16
Fuori misura: Si

Designer: Stilhaus
Material: Solid brass bar 30x20
Accessories: White ceramic
Finishes: 08 - 16
Customized: Yes

Designer: Stilhaus
Matériel: Laiton massif bar 30x20
Accessoires: Blanc céramique
Finitions: 08 - 16
Personnalisé: Oui

Designer: Stilhaus
Material: Aus massivem messing bar
30x20
Zubehör: Weiße keramik
Ausführungen: 08 - 16
Kundenwunsch: Ja

Дизайн: Stilhaus
Материал: латунь
Аксессуары: белая керамика
Отделка: 08 - 16
Негабаритный: да



GE 69



GE 16



GE 11
GE 12

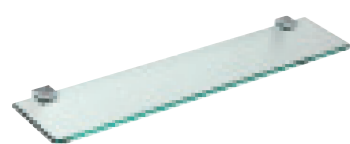

GE 04

Mensola 8 mm
Shelf
Etagère
Ablage

Стекло 8 mm
Stainless steel - thickness of glass 8 mm
cm 60 L x 13 P x 2 H x 50

- 08
- 16



GE 05

Asta porta asciugamani
Towel rail
Porte serviettes
Handtuchhalter

полотенцедержатель
cm 56 L x 8 P x 2 H x 49 INT

- 08
- 16



GE 45

Asta porta asciugamani
Towel rail
Porte serviettes
Handtuchhalter

полотенцедержатель
cm 45 L x 8 P x 2 H x 49 INT

- 08
- 16



GE 06

Asta porta salviette
Towel rail
Porte serviettes
Handtuchhalter

Полотенцедержатель
cm 30 L x 8 P x 2 H x 23 INT

- 08
- 16



GE 69

Asta cm 45 con porta sapone DX
Towel rail with soap dish
Porte serviettes avec porte savon
Handtuchhalter mit Seifenschale

Полотенцедержатель + керамическая мыльница
cm 47,5 L x 9 P x 5 H x 38 INT

- 08
- 16

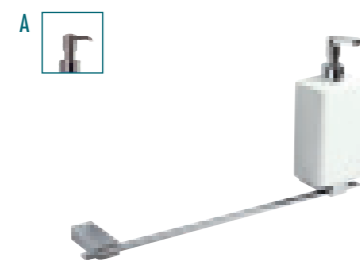

GE 69 D

Asta cm 45 con dosatore di sapone DX
Towel rail with liquid soap dispenser
Porte serviettes avec dosator de savon
Handtuchhalter mit Seifenspender

Полотенцедержатель + керамический дозатор
cm 46 L x 8 P x 22 H x 38 INT

- 08
- 08 A
- 16 A



GE 16

Porta asciugamani a snodo 2 aste
Towel rail with 2 adjustable bar
Porte serviettes à 2 barres orientables
Handtuchhalter schwenkbar 2 Stangen

Полотенцедержатель двойной поворотный
cm 31 L x 3,5 P x 5 H

- 08
- 16



GE 07

Anello porta salviette
Serviette holder to ring shaped
Porte serviettes à anneau
Handtuchring

Полотенцедержатель - полукольцо
cm 25 L x 8 P x 12 H

- 08
- 16



GE 79

Anello porta salviette con sapone
Serviette holder with soap
Porte serviettes à anneau avec savon
Handtuchhalter + Seifenschale wandhängend

Полотенцедержатель - полукольцо + керамическая мыльница
cm 25 L x 9 P x 14 H

- 08
- 16

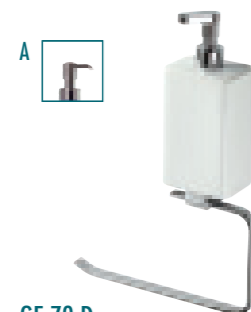

GE 79 D

Anello porta salviette con dosatore sapone
Serviette holder with soap dispenser
Porte serviettes à anneau avec doseur de savon
Handtuchhalter + Seifenspender wandhängend

Полотенцедержатель - полукольцо + керамический дозатор
cm 25 L x 8 P x 31 H

- 08
- 08 A
- 16 A



GE 09

Porta sapone a parete
Wall ceramic soap dish
Porte savon en céramique
Seifenschale wandhängend

Настенная керамическая мыльница
cm 12 L x 9 P x 5 H

- 08
- 16



GE 10

Porta bicchiere a parete
Wall tooth brush holder
Porte verre en céramique
Zahnbürstenhalter wandhängend

Настенный керамический стакан
cm 9 L x 8 P x 16 H

- 08
- 16





GE 30

Dosatore sapone a parete
Wall liquid soap dispenser holder
Doseur de savon liquid en céramique
Seifenspender

Настенный керамический дозатор
cm 9 L x 8 P x 22 H

- 08
- 08 A
- 16 A



GE 13

Porta accappatoio
Robe hook
Porte peignoir
Bademantelhaken

Крючок
cm 2 L x 3 P x 3 H

- 08
- 16



GE 09 AP

Porta sapone d'appoggio
Soap dish
Porte savon
Seifenschale

Настольная керамическая мыльница
cm 12 L x 8 P x 2 H

- 08



GE 13.2

Porta accappatoio (2 ganci)
Robe hook (2 hooks)
Porte peignoir (2 crochets)
Bademantelhaken

Крючок двойной
cm 10 L x 8 P x 2 H

- 08
- 16



GE 10 AP

Bicchiere d'appoggio
Ceramic glass
Verre en céramique d'appui
Zahnputzbecher

Настольный керамический стакан
cm 9 L x 7 P x 13 H

- 08

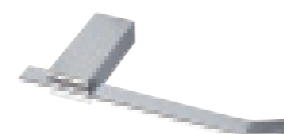

GE 11

Porta rotolo
Paper holder
Porte rouleau
Papierrollenhalter

Бумагодержатель
cm 19 L x 8 P x 2 H

- 08
- 16



GE 30 AP

Dosatore sapone liquido d'appoggio
Ceramic liquid soap dispenser
Porte savon liquid en céramique
Seifenspender

Настольный керамический дозатор
cm 9 L x 6,9 P x 19 H

- 08
- 08 A
- 16 A



GE 11 C

Porta rotolo con coperchio
Covered paper holder
Porte rouleau avec couvercle
Papierrollenhalter mit Deckel

Бумагодержатель с крышкой
cm 13 L x 13 P x 10 H

- 08
- 16

FINITURA



ORO
Gold
Or
Gold
Золото

16*



CROMO
Chrome
Chrom
хром

08

★FINITURA DISPONIBILE IN 20 GG.

Finish available in 20 days
Finition disponible en 20 jours
Oberfläche lieferbar in 20 Tagen
Отделка доступна в течение 20 дней



Su richiesta si realizzano aste porta asciugamani su misura, 20 gg

Customized towel rails are available on request, 20 days
Des porte-serviettes personnalisés sont disponibles sur demande, 20 jours
Handtuchhalter sind auf Anfrage erhältlich, 20 Tagen

По запросу мы можем производить полотенцедержатели под размер 20 дней



- 08 25 → 44 cm
- 08 47 → 100 cm
- 16 25 → 44 cm
- 16 47 → 100 cm



GE 11.2

Porta rotolo doppio
Double paper holder
Porte rouleau double
Papierrollenhalter doppelt

Бумагодержатель двойной
cm 30 L x 8 P x 2 H

- 08
- 16



GE 11 S

Porta rotolo scorta
Paper holder of supply
Porte rouleau s'escort
Ersatzpapierrollenhalter

Бумагодержатель вертикальный
cm 3 L x 8 P x 18 H

- 08
- 16



GE 12 A

Porta scopino d'appoggio in ceramica
Ceramic toilet brush
Porte balaynet en ceramique
Bürstengarnitur freistehend aus Keramik

Напольный керамический ёрш
cm 10 L x 10 P x 42 H

- 08
- 16



GE 039 M

Porta scopino a parete
Wall ceramic toilet brush
Porte balaynet à mur
Bürstengarnitur wandhängend

Настенный металлический ёрш
cm 8 L x 8 P x 43 H

- 08
- 16



> pag. 250



> pag. 282



> pag. 377

Complementi / complements / compléments / ergänzungen / Дополнительно

Attenzione misurata



HASHI

Designer: Gianluca Paludi
Materiale: Barra ottone Ø 14 e Ø 8
Finiture: 08 - 23 - 24
Fuori misura: Sì

Designer: Gianluca Paludi
Material: Solid Brass Bar Ø14 and Ø8
Finishes: 08 - 23 - 24
Customized: Yes

Designer: Gianluca Paludi
Matériel: laiton massif Bar Ø14 e Ø8
Finitions: 08 - 23 - 24
Personnalisé: Oui

Designer: Gianluca Paludi
Material: aus massivem Messing Bar Ø14
und Ø8
Ausführungen: 08 - 23 - 24
Kundenwunsch: Ja

Дизайнер: Gianluca Paludi
Материал: латунь
Аксессуары: белая керамика
Покрытие: 08 - 23 - 24
Негабаритный: да

HS 45



HS 11



HS 13



HS 09
HS 10
HS 30



HS 04

Mensola acciaio Inox
Inox Shelf
Étagère en Inox
Ablage
Полка из нержавеющей стали
cm 60 L x 12 P x 3 H

• 08 - 23 - 24



HS 05

Asta porta asciugamani
Towel rail
Porte serviettes
Handtuchhalter
Полотенцедержатель
cm 60 L x 7 P x 3 H - INT. 57

• 08 - 23 - 24

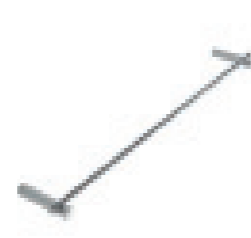

HS 45

Asta porta asciugamani
Towel rail
Porte serviettes
Handtuchhalter
Полотенцедержатель
cm 45 L x 7 P x 3 H - INT. 42

• 08 - 23 - 24



HS 06

Asta porta salviette
Towel rail
Porte serviettes
Handtuchhalter
Полотенцедержатель
cm 30 L x 7 P x 3 H - INT. 27

• 08 - 23 - 24



HS 13

Porta accappatoio
Robe hook
Porte peignoir
Bademantelhaken
Крючок
cm 3 L x 4,5 P x 12 H

• 08 - 23 - 24



HS 11

Porta rotolo
Paper holder
Porte rouleau
Papierrollenhalter
Бумагодержатель
cm 20 L x 6 P x 3 H

• 08 - 23 - 24



010

Porta scopino
Toilet-brush
Porte balayent
Bürstengarnitur freistehend
Напольный керамический ёрш
cm ø 8 x 40 H

• 08 - 23 - 24

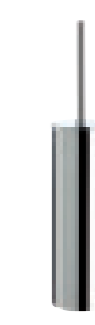

010 M

Porta scopino a parete
Wall mounted toilet-brush
Porte balayent à mur
Bürstengarnitur wandhängend
Настенный металлический ёрш
cm ø 8 x 40 H

• 08 - 23 - 24



HS 07

Anello porta salviette
Ring serviette holder
Porte serviettes à anneau
Handtuchring
Полотенцедержатель – кольцо
cm Ø 20 x 7 P

• 08 - 23 - 24



HS 09 M

Porta sapone a parete
Wall mounted soap dish
Porte savon à mur
Seifenschale wandhängend
Настенная металлическая мыльница
cm Ø 11 x 14 P x 3,5 H

• 08 - 23 - 24



HS 10 M

Porta bicchiere a parete
Wall mounted glass holder
Porte verre à mur
Zahnbürstenhalter wandhängend
Настенный металлический стакан
cm Ø 6 x 11,5 H

• 08 - 23 - 24



HS 30 M

Dosatore sapone liquido a parete
Wall mounted soap dispenser
Doseur de savon à mur
Seifenspender wandhängend
Настенный металлический дозатор
cm Ø 6 x 18 H

• 08 - 23 - 24



HS 00

Basetta di rifinitura a muro
Plate
Rondelle murale
Scheibe
Отражатели
cm Ø 3

• 08 - 23 - 24



HS 16

Porta asciugamani snodo 2 aste
Towel rail with 2 adjustable bar
Porte serviettes à 2 barres orientables
Handtuchhalter schwenkbar 2 Stangen
Полотенцедержатель двойной поворотный
cm 3 L x 33 P x 8 H

• 08 - 23 - 24



HS 09 AP

Porta sapone da appoggio
Soap dish with base
Porte savon d'appui
Seifenschale freistehend
Настольная металлическая мыльница
cm Ø 11 x 3,5 H

• 08



HS 10 AP

Bicchiere da appoggio
Glass with base
Verre d'appui
Zahnputzbecher freistehend
Настольный металлический стакан
cm Ø 6 x 11,5 H

• 08



HS 30 AP

Dosatore sapone d'appoggio
Soap dispenser with base
Porte savon d'appui
Seifenspender freistehend
Настольный металлический дозатор
cm Ø 6 x 18 H

• 08

FINITURA



CROMO
Chrome
Chrome
Chrom
хром

BIANCO OPACO
Matt white
Blanc opaque
Weiße
белый матовый

NERO OPACO
Matt black
Noir opaque
Mattschwarz
черный матовый

08

24

23

HASHI
Designer: Gianluca Paludi



Meccanica di settore



KREA

Designer: Paolo Galletti e Daniele Maltinti
Materiale: Piatto inox 304
Accessori: Ceramica bianca
Finiture: 54 - 55 - 23
Combinazioni: 4000
Modello registrato N. 402017000142123
Brevetto utilità N. 202017000150252

Designer: Paolo Galletti e Daniele Maltinti
Materiale: Inox 304
Accessories: White ceramic
Finishes: 54 - 55 - 23
Combinations: 4000
European patent model No. 402017000142123
European patent utility No. 202017000150252

Designer: Paolo Galletti e Daniele Maltinti
Matériau: Inox 304
Accessoires: Blanc céramique
Finitions: 54 - 55 - 23
Combinaisons: 4000
Brevet Européen modèle No. 402017000142123
Brevet Européen utilitaires 202017000150252

Designer: Paolo Galletti e Daniele Maltinti
Materiale: Inox 304
Zubehör: Weiße Keramik
Ausführungen: 54 - 55 - 23
Kombinationen: 4000
Europäisches Patent modell Nr. 402017000142123
Europäisches Patent dienstprogramm Nr. 202017000150252

Разработка дизайна: Paolo Galletti e Daniele Maltinti
Материал: латунь 30x20
Аксессуары: белая керамика
Отделка: 54 - 55 - 23 комбинации: 4000
европейский патент модель № 402017000142123
европейский патент сервис. программа № 202017000150252



KR 00
KR 01
KR DEC 1 AR
KR 06
KR 11
KR 08
KR 039 M



KR 00
KR 01
KR 10
KR 30



KR 00
KR 01
KR DEC 1 LG
KR 06
KR 11
KR 30



KR 00

Attacco a parete
Bracket for wall
Support mural
Wandhalterung
крепление к стене
cm Ø 7

- 55
- 54 - 23



KR 01

Finale
Final part
Partie finale
Abschlußteil
наконечники
cm Ø 4 x 2 P

- 08
- 54 - 23



KR 06

Asta 28
Tower rail
Porte serviettes
Handtuchhalter
Полотенцедержатель
cm 40 L x 7,5 H

- 55
- 54 - 23



KR 09

Porta sapone
Soap dish
Porte savon
Seifenschale
Настенная керамическая мыльница
cm 17 L x 13 P x 15 H

- 55
- 54 - 23



KR 10

Porta bicchiere
Glass
Verre
Zahnputzbecher
Настенный керамический стакан
cm 13 L x 6 P x 19 H

- 55
- 54 - 23



KR 30

Dosatore sapone liquido
Liquid soap dispenser
Porte savon liquid
Seifenspender
Настенный керамический дозатор
cm 13 L x 11 P x 21 H

- 55
- 54 - 23



KR 08

Mensola porta oggetti
Shelf
Étagère portant des objets
Regal
полка для настольных предметов
cm 19 L x 11 P x 17 H

- 55
- 54 - 23



KR 13 P

Porta accappatoio corto
Robe hook
Porte peignoir
Bademantelhaken
Крючок
cm 15 L x 4 P x 8 H

- 55
- 54 - 23

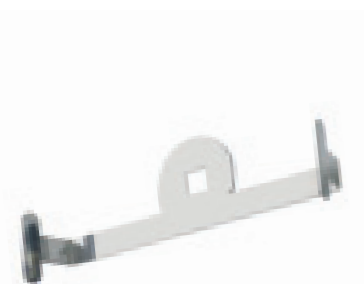

KR 13 G

Porta accappatoio lungo
Robe hook
Porte peignoir
Bademantelhaken
Крючок
cm 27 L x 4 P x 8 H

- 55
- 54 - 23



KR 11

Porta rotolo
Paper holder
Porte rouleau
Papierrollenhalter
Бумагодержатель
cm 18 L x 8 P x 7,5 H

- 55
- 54 - 23



KR 039 M

Porta scopino a parete
Wall mounted toilet-brush
Porte balayent à mur
Bürstengarnitur wandhängend
Настенный металлический ёрш
cm 8 L x 8,5 P x 56 H

- 55
- 54 - 23





SOME EXAMPLES

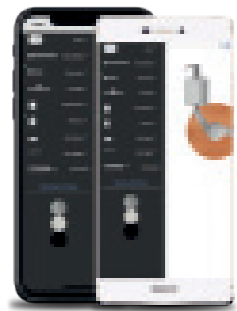

stilhaus

CONFIGURA LA TUA KREA CON LA NOSTRA APP

Configure your Krea with our App

Configurez votre Krea avec notre application

Konfigurieren sie ihr Krea mit unserer App

Настройте свой KREA с нашим APP





KR DEC 1

Decoro
Decorum
Decorum
Dekor-Rosette
декор
cm Ø 20

- BI - NE - BL - VE - RO - AR
- LG



KR DEC 2

Decoro
Decorum
Decorum
Dekor-Rosette
декор
cm 20 L x 20 H

- BI - NE
- LG

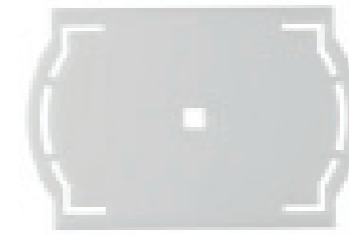
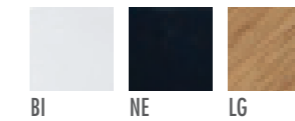

KR DEC 3

Decoro
Decorum
Decorum
Dekor-Rosette
декор
cm 30 L x 20 H

- BI - NE
- LG

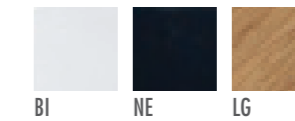

FINITURA



ACCIAIO SATINATO
Satin steel
Acier satiné
Stahl satiniert
сатинированная сталь

54



ACCIAIO LUCIDO
Satin steel
Acier satiné
Stahl satiniert
Полированная сталь

55



NERO OPACO
Matt black
Noir opaque
Matt schwarz
черный матовый

23

SCHEMA DI MONTAGGIO

Assembly scheme / Schéma d'assemblage / Montageschema / Схема сборки



ESEMPIO
EXAMPLE
EXEMPLE
BEISPIEL
Пример

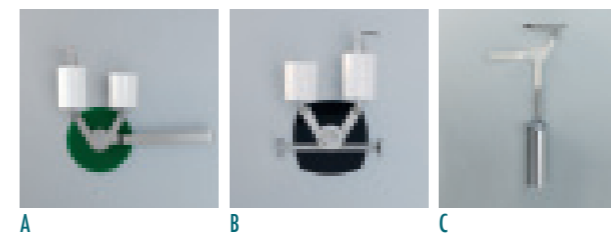

- A KR 00 + KR 01 KR DEC 1 + KR 10 + KR 30 + KR 06
- B KR 00 + KR 01 KR DEC 2 + KR 30 + KR 10 + KR 13 G
- C KR 00 + KR 01 KR 08 M + KR 11 + KR 039

KREA: Modello registrato N. 402017000142123
KREA: European patent model N. 402017000142123
KREA: Brevet Européen modèle N. 402017000142123
KREA: Europäisches Patent modell Nr. 402017000142123
KREA: KREA: Европейский патент модель № 402017000142123

KREA: Brevetto utilità N. 202017000150252
KREA: European patent utility N. 202017000150252
KREA: Brevet Européen utilitaires N. 202017000150252
KREA: Europäisches Patent dienstprogramm Nr. 202017000150252
KREA: Европейский патент сервис. программа № 202017000150252

Magnetismo consapevole



Designer: Stilhaus
Materiale: Ottone, tubo ø16, basetta a muro ø 50
Accessori: Vetro Satinato
Finitura: 08
Fuori misura: Sì
Incollo : Sì

Designer: Stilhaus
Material: Brass tube ø 16, fixing plate cover ø50
Accessories: Frosted glass
Finishes: 08
Customized: Yes
By glue : Yes

Designer: Stilhaus
Matière: Laiton, tuyau ø16, boucle couvre-vis ø50
Accessoires: Verre satin
Finitions: 08
Personnalis : Oui
Par collage : Oui

Designer: Stilhaus
Material: Messing Rohr ø 16, Befestigungsplatten Oberfl che ø 50
Zubeh r: Mattglas
Ausf hrungen: 08
Kundenwunsch: Ja
Kleber: Ja

Дизайн: Stilhaus Используемый
Материал: латунь ø 16, ø
50 Аксессуары: сатиновое
стекло Отделка: 08
хром Негабаритный: да Установка
на клей: да

LZ 45



LZ 13



LZ 11





LZ 04

Mensola vetro 8mm
Shelf
Etagère
Ablage
Стеклоянная полка - толщина стекла 8 мм
cm 60 L x 12 P x 5 H

•08



LZ 05

Asta porta asciugamani
Towel rail
Porte serviettes
Handtuchhalter
Полотенцедержатель
cm 63 L x 8 P x 5 H - INT. 58

•08

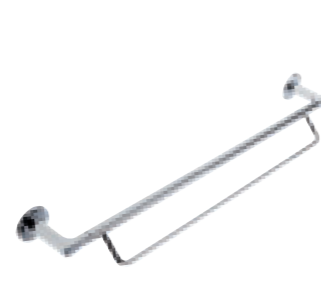

LZ 05.2

Asta porta asciugamani con 2 aste
Chromed towel rail with 2 bar
Porte serviettes chromée à 2 barres
Handtuchhalter 2 Stangen
Полотенцедержатель двойной
cm 63 L x 13 P x 6 H - INT. 58

•08



LZ 45

Asta porta asciugamani
Towel rail
Porte serviettes
Handtuchhalter
Полотенцедержатель
cm 49 L x 8 P x 5 H - INT. 44

•08



LZ 45.2

Asta porta asciugamani con 2 aste
Chromed towel rail with 2 bar
Porte serviettes chromée à 2 barres
Handtuchhalter 2 Stangen
Полотенцедержатель двойной
cm 49 L x 13 P x 6 H - INT. 44

•08



LZ 06

Asta porta salviette
Towel rail
Porte serviettes
Handtuchhalter
Полотенцедержатель
cm 36 L x 8 P x 5 H - INT. 31

•08



LZ 06.2

Asta porta salviette con 2 aste
Chromed towel rail with 2 bar
Porte serviettes chromée à 2 barres
Handtuchhalter 2 Stangen
Полотенцедержатель двойной
cm 36 L x 8 P x 6 H - INT. 31

•08



LZ 06.1

Asta porta salvietta singola
Single towel rail
Porte serviettes
Handtuchhalter
Полотенцедержатель
cm 5,5 L x 30 P x 5,5 H

•08



LZ 45.2



LZ 16

Porta asciugamani snodo 2 aste
Towel rail with 2 adjustable bar
Porte serviettes à 2 barres orientables
Handtuchhalter schwenkbar 2 Stangen
Полотенцедержатель двойной поворотный
cm 3 L x 33 P x 8 H

•08



LZ 07

Anello porta salviette
Ring serviette holder
Porte serviettes à anneau
Handtuchring
Полотенцедержатель - кольцо
cm 21 Ø x 8 P x 25 H

•08



LZ 09

Porta sapone a parete
Wall-mounted soap dish
Porte savon à mur
Seifenschale wandhängend
Настенная керамическая мыльница
cm 13,5 L x 10,5 P x 9 H

•08



LZ 09 M

Porta sapone a parete
Wall-mounted soap dish
Porte savon à mur
Seifenschale
Настенная металлическая мыльница
cm 12 L x 10 P x 5 H

•08



LZ 10

Porta bicchiere a parete
Wall-mounted glass holder
Porte verre à mur
Zahnbrüstenhalter wandhängend
Настенный керамический
cm 8 L x 11 P x 17 H

•08



LZ 30

Dosatore sapone liquido a parete
Wall-mounted soap dispenser
Doseur de savon
Seifenspender
Настенный керамический дозатор
cm 8 L x 11 P x 23 H

•08



LZ 09 AP

Porta sapone d'appoggio
Soap dish
Porte savon
Seifenschale
Настольная керамическая мыльница
cm 13,5 L x 9 P x 2 H

•08



LZ 10 AP

Bicchiere d'appoggio
Glass
Verre
Zahnputzbecher
Настольный керамический стакан
cm Ø 8 x 11,5 H

•08





LZ 30 AP

Dosatore sapone liquido d'appoggio
Liquid soap dispenser
Porte savon liquid
Seifenspender
Настольный керамический дозатор
cm Ø 8 x 17 H

• 08



LZ 34

Supporto: p. sapone/bicchiere/dosatore
Support: soap/glass/soap dispenser holder
Supporte: p. savon/verre/doseur
Halter: Seifenschale/Zahnputzbecher/Seifenspender
Настенный держатель для мыльницы/
дозатора /стакана
cm 7 L x 10 P x 5 H

• 08



LZ 35

Supporto doppio: p. sapone/bicchiere/dosatore
Double support: soap/glass/soap dispenser holder
Supporte double: p. savon/verre/doseur
Doppelhalter: Seifenschale/Zahnputzbecher/Seifenspender
Настенный держатель двойной для
мыльницы/дозатора/стакана
cm 22 L x 10 P x 5 H

• 08



LZ 041.08

Porta sapone in vetro
Glass soap dish
Porte savon en verre
Seifenschale aus Glas
Настенный держатель двойной для
cm 12 L x 12 P x 4 H

• 08



LZ 039

Porta scopino da appoggio
Toilet-brush with base
Porte balayent d'appui
Bürstengarnitur freistehend
Напольный металлический ёрш
cm 8 L x 8 P x 40 H

• 08



840

Kit collante e biadesivo per un articolo
Kit with bi-adhesive and glue for one article
Kit avec collant et biadhésif pour un article
Klebekit ist ein beidseitiger Klebestreifen
Возможность установки на клей.Ыфдгеш

• 08



LZ 040.06

Bicchiere in vetro
Glass holder
Porte verre
Zahnbürstenhalter aus Glas
Стеклянный стакан
cm 6 L x 6 P x 8 H

• 08



LZ 037.01

Dosatore sapone liquido in vetro con
pompetta metallo
Glass liquid soap dispenser with chrome pomp
Doseur de savon liquid en verre avec pompe
Seifenspender aus Glas
Стеклянный дозатор
cm 8 L x 8 P x 9 H

• 08



LZ 13

Porta accappatoio
Robe hook
Porte peignoir
Bademantelhaken
Крючок
cm 5,5 L x 2 P x 5,5 H

• 08

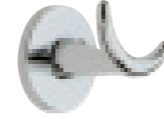

LZ 13.2

Porta accappatoio (2 ganci)
Robe hook (2 hooks)
Porte peignoir (2 crochets)
Bademantelhaken (2 Haken)
Крючок гнутый
cm 5,5 L x 5,5 P x 5,5 H

• 08



Su richiesta si realizzano aste porta asciugamani su misura, 20 gg

Customized towel rails are available on request, 20 days
Des porte-serviettes personnalisés sont disponibles sur demande, 20 jours
Handtuchhalter sind auf Anfrage erhältlich, 20 Tagen

По запросу мы можем производить полотенцедержатели под размер 20 дней



• 08 25 → 45 cm

• 08 47 → 100 cm



LZ 11

Porta rotolo
Paper holder
Porte rouleau
Papierrollenhalter
Бумагодержатель
cm 19 L x 8 P x 5 H

• 08



LZ 11 C

Porta rotolo coperto
Covered paper holder
Porte rouleau avec couvercle
Papierrollenhalter mit Deckel
Бумагодержатель с крышкой
cm 14 L x 12 P x 13 H

• 08



LZ 11 S

Porta rotolo di scorta
Supply paper holder
Porte rouleau d'escorte
Ersatzpapierrollenhalter
Бумагодержатель вертикальный
cm 7 L x 10 P x 23 H

• 08



LZ 039 M

Porta scopino a parete
Wall mounted toilet-brush
Porte balayent à mur
Bürstengarnitur wandhängend
Настенный металлический ёрш
cm 8 L x 9 P x 40 H

• 08

Complementi / complements / compléments / ergänzungen / Дополнительно



> pag. 256



> pag. 317



> pag. 317



> pag. 317



> pag. 317



Scelta vincente

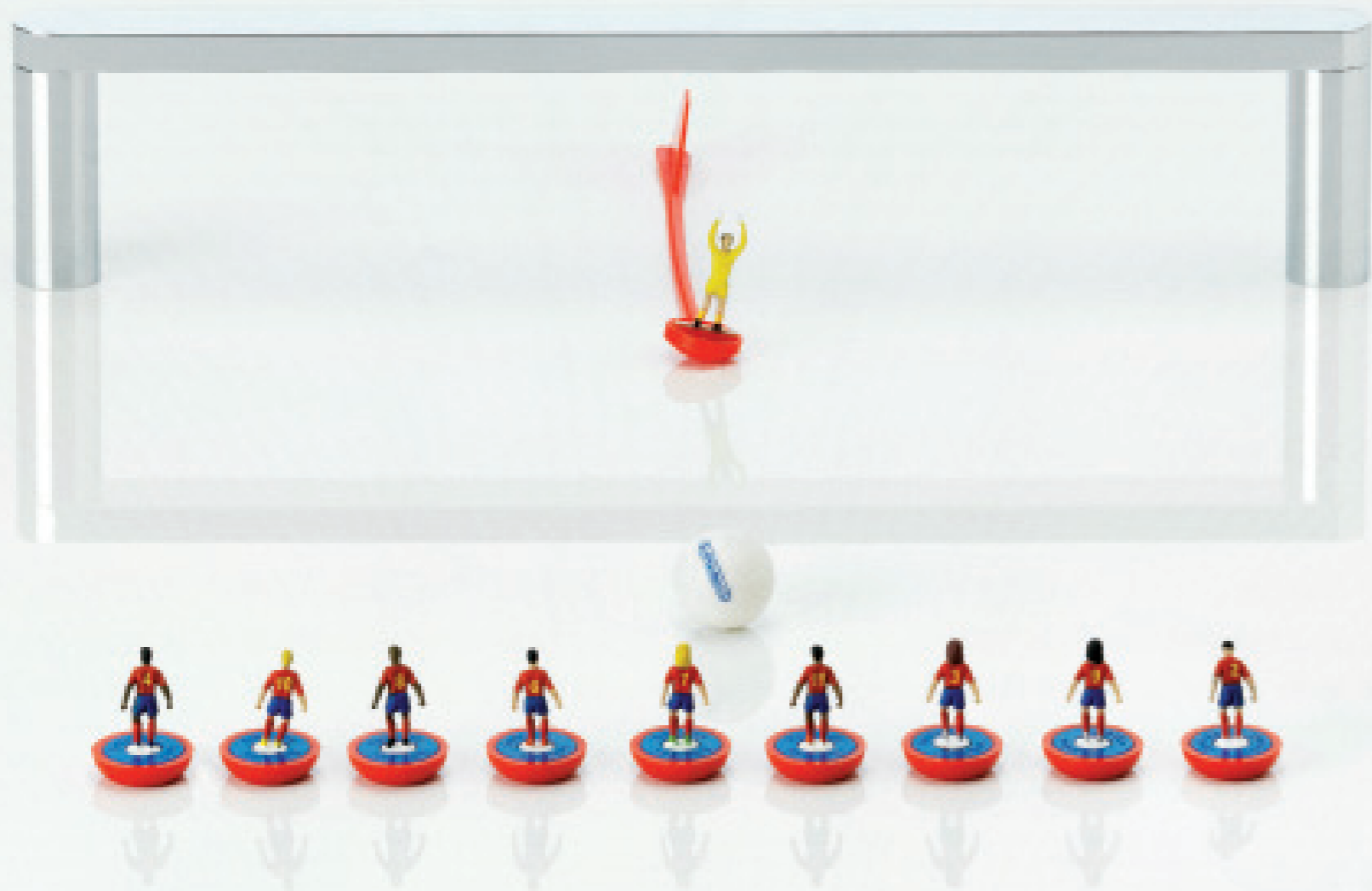

LIVING

Designer: BGR Industrial design
Materiale: Barra alluminio 20x12 e
ottone Ø 20
Accessori: Ceramica bianca
Finiture: 03-05-08
Fuori misura: No

Designer: BGR Industrial design
Material: Solid aluminum 20x12 and brass
Accessories: white ceramic
Finishes: 03-05-08
Customized: No

Designer: BGR Industrial design
Matériel: Aluminium massif 20x12 et
laiton 20
Accessoires: Blanc céramique finitions:
03-05-08
Personnalisé: No

Designer: BGR Industrial design
Material: aus massivem Aluminium 20x12
aus Messing 20
Zubehör: weiße Keramik
Ausführungen: 03-05-08
Kundenwunsch: Nein

Дизайн: BGR Industrial design
Материал: алюминий и латунь
20x12 Ø 20 Аксессуары: белая
керамика Отделка: 03-05-08
хром Негабаритный: нет

LV 45



LV 11 A



LV 13



LV 30
LV 10



LV 05
Asta porta asciugamani
Towel rail
Porte serviettes
Handtuchhalter
полотенцедержатель
cm 62 L x 7 P x 2 H - INT. 60

• 08 - 03 - 05



LV 45
Asta porta asciugamani
Towel rail
Porte serviettes
Handtuchhalter
полотенцедержатель
cm 47 L x 7 P x 2 H - INT. 45

• 08 - 03 - 05



LV 06
Asta porta salviette
Towel rail
Porte serviettes
Handtuchhalter
Полотенцедержатель
cm 32 L x 7 P x 2 H - INT.30

• 08 - 03 - 05

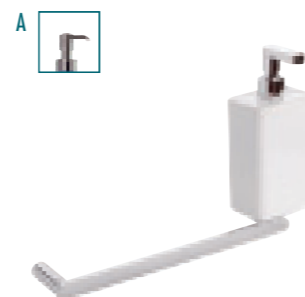

LV 69 D
Asta con dosatore sapone
Towel rail with liquid soap dispenser
Porte serviettes avec dosator de savon
Handtuchring mit Seifenspender
Полотенцедержатель +
керамический дозатор
cm 35 L x 7 P x 21 H - INT. 30

• 08 - 03 - 05
• 08 A - 03 A - 05 A



LV 11 A
Porta rotolo
Paper holder
Porte roleau
Papierrollenhalter
бумагодержатель
cm 20 L x 6,5 P x 2,5 H

• 08 - 03 - 05



LV 11
Porta rotolo
Paper holder
Porte roleau
Papierrollenhalter
бумагодержатель
cm 2 L x 12 P x 3,5 H

• 08 - 03 - 05



LV 039M
Porta scopino a parete
Wall mounted toilet-brush
Porte balayent à mur
Bürstengarnitur wandhängend
Настенный металлический ёрш
cm 8 L x 8 P x 45 H

• 08 - 03 - 05



LV 12 A
Porta scopino d'appoggio in ceramica
Ceramic toilet brush
Porte balayent en ceramique
Bürstengarnitur freistehend aus Keramik
Напольный керамический ёрш
cm 10 L x 10 P x 42 H

• 08 - 03 - 05



LV 69
Asta con porta sapone
Towel rail with soap dish
Porte serviettes avec porte savon
Handtuchhalter mit Seifenschale
Полотенцедержатель +
керамическая мыльница
cm 37 L x 8 P x 4 H - INT. 30

• 08 - 03 - 05

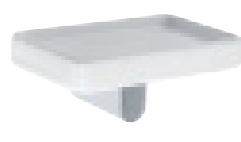

LV 09
Porta sapone a parete
Wall mounted ceramic soap dish
Porte savon à mur en céramique
Seifenschale wandhängend aus Keramik
Настенная керамическая мыльница
cm 12 L x 9 P x 5 H

• 08



LV 10
Porta bicchiere a parete
Wall mounted ceramic glass holder
Porte verre à mur en céramique
Zahnbürstenhalter wandhängend aus Keramik
Настенный керамический стакан
cm 9 L x 7,5 P x 16 H

• 08



LV 30
Porta dosatore sapone liquido in ceramica
Ceramic liquid soap dispenser holder
Doseur de savon liquid en céramique
Seifenspender aus Keramik
Настенный керамический дозатор
cm 9 L x 7,5 P x 21,5 H

• 08
• 08 A



LV 09 AP
Porta sapone d'appoggio
Soap dish
Porte savon
Seifenschale
Настольная керамическая мыльница
cm 12 L x 7 P x 2 H

• 08



LV 10 AP
Bicchiere d'appoggio
Glass
Verre
Zahnputzbecher
Настольный керамический стакан
cm 9 L x 6 P x 14,5 H

• 08



LV 30 AP
Dosatore sapone liquido d'appoggio
Liquid soap dispenser
Porte savon liquid
Seifenspender
Настольный керамический дозатор
cm 9 L x 6,5 P x 19 H

• 08
• 08 A



LV 13
Porta accappatoio
Robe hook
Porte peignoir
Bodemantelhaken
Крючок
cm 2 L x 3,5 P x 3,5 H

• 08 - 03 - 05

FINITURA



BIANCO/CROMO
White/Chrome
Blanche/Chrome
Weiß/Chrom
Белый матовый / хром

03



NERO/CROMO
Black/Chrome
Noir/Chrome
Schwarz/Chrom
черный матовый / хро

05



CROMO
Chrome
Chrome
Chrom
хром

08



Lieto fine



Designer: Stilhaus
Materiale: Ottone, tubo ø16, basetta ø muro ø 50
Accessori: Vetro Satinato
Finitura: 08-36-23
Fuori misura: Sì
Incollo : Sì

Designer: Stilhaus
Material: Brass tube ø 16, fixing plate cover ø50
Accessories: Frosted glass
Finishes: 08-36-23
Customized: Yes
By glue : Yes

Designer: Stilhaus
Matière: Laiton, tuyau ø16, boucle couvre-vis ø50
Accessoires: Verre satin
Finitions: 08-36-23
Personnalisé: Oui
Par collage : Oui

Designer: Stilhaus
Material: Messing Rohr ø 16, Befestigungsplatten Oberfläche ø 50
Zubehör: Mattglas
Ausführungen: 08-36-23
Kundenwunsch: Ja
Kleber: Ja

Дизайн: Stilhaus Используемый
Материал: латунь ø 16, ø 50
Аксессуары: сатинированное
стеклоОтделка: 08 хром,
36 никель сатин, 23 черный
матовыйНегабаритный: да
Установка на клей: да

ME 06.2



ME 808



ME 79



ME 30
ME 10 M
ME 09 M



ME 04

Mensola con vetro trasparente 8 mm
Shelf with transparent glass plane
Étagère avec plan en verre transparent
Ablage aus klarem Glas
Стеклоянная полка с ограждением – толщина 8 мм
cm 60 L x 12 P x 5 H

- 08 - 23
- 36



ME 05

Asta porta asciugamani
Towel rail
Porte serviette
Handtuchhalter
Полотенцедержатель
cm 61 L x 7 P x 5 H - INT. 56,50

- 08 - 23
- 36



ME 05.2

Porta asciugamani doppia asta
Towel rail 2 bars
Porte serviette avec 2 bar
Handtuchstange doppelt
Полотенцедержатель двойной
cm 61 L x 11 P x 5 H - INT. 56,50

- 08 - 23
- 36



ME 45

Asta porta asciugamani
Towel rail
Porte serviette
Handtuchhalter
Полотенцедержатель двойной
cm 48 L x 7 P x 5 H - INT. 43,50

- 08 - 23
- 36



ME 06

Asta porta salviette
Towel rail
Porte serviettes
Handtuchhalter
Полотенцедержатель
cm 33 L x 7 P x 5 H - INT. 28,5

- 08 - 23
- 36



ME 06.2

Porta salviette doppia asta
Towel rail 2 bars
Porte serviettes avec 2 bar
Handtuchstange doppelt
Полотенцедержатель двойной
cm 33 L x 11 P x 5 H - INT. 28,50

- 08 - 23
- 36



ME 69

Asta porta salviette con porta sapone
Towel rail with soap dish
Porte serviettes avec porte savon
Handtuchhalter mit Seifenschale
Полотенцедержатель + стеклянная
мыльница
cm 48 L x 11 P x 4,5 H - INT. 43,50

- 08 - 23
- 36



ME 16

Porta asciugamani a bandiera 2 aste
Towel rail with 2 adjustable bar
Porte serviettes à 2 barres orientables
Handtuchhalter schwenkbar 2 Stangen
Полотенцедержатель двойной оворотный
cm 33 L x 5 P x 9 H

- 08 - 23
- 36



ME 07

Anello porta salviette
Serviette holder to ring shaped
Porte serviettes à anneau
Handtuchring
Полотенцедержатель – кольцо
cm 23 Ø x 5 P x 26 H

- 08 - 23
- 36



ME 79

Anello porta salviette/dosatore
Serviette holder with metal liquid soap dispenser
Porte serviettes à anneau avec doseur
Handtuchring mit Seifenspender aus Metall
Полотенцедержатель – кольцо +
металлический дозатор
cm 23 Ø x 9 P x 29 H

- 08 - 23
- 36



ME 09

Porta sapone in vetro
Glass soap dish
Porte savon en verre
Seifenschale aus Glas
Настенная стеклянная мыльница
cm 12 L x 12 P x 8 H

- 08 - 23
- 36



ME 09 M

Porta sapone in ottone
Brass soap dish
Porte savon en laiton
Seifenschale aus Messing
Настенная металлическая мыльница
cm 12 L x 8 P x 9 H

- 08 - 23
- 36





ME 10

Porta bicchiere in vetro
Glass holder
Porte verre
Zahnbürstenhalter aus Glas
Настенный стеклянный стакан
cm 8 L x 11 P x 11 H

- 08 - 23
- 36



ME 10 M

Porta bicchiere in ottone
Brass glass holder
Porte verre en laiton
Zahnbürstenhalter aus Messing
Настенный металлический стакан
cm 7 L x 11 P x 11 H

- 08 - 23
- 36



ME 30

Porta dosatore sapone liquido
Brass wall-mounted liquid soap dispenser
Doseur de savon liquid en laiton
Seifenspender aus Messing
Настенный металлический дозатор
cm 5 L x 9 P x 18 H

- 08 - 23
- 36



ME 09 M AP

Porta sapone da appoggio
Leaning soap dish
Porte savon d'appui
Seifenschale freistehend
Настольная стеклянная мыльница
cm 13 Ø x 2,5 H

- 08



ME 039

Porta scopino in ottone da appoggio
Brass toilet-brush with base
Porte balayent en laiton d'appui
Büstengarnitur freistehend aus Messing
Напольный металлический ёрш
cm 8 Ø x 42 H

- 08 - 23
- 36



840

Kit collante e biadesivo per un articolo
Kit with bi-adhesive and glue for one article
Kit avec collant et biadhésif pour un article
Klebekit ist ein beidseitiger Klebestreifen
Клей

-

FINITURA



CROMO
Chrome
Chrome
Chrom
хром



NICHEL SATINATO
Satin nickel
Nickel satiné
Nickel satiniert
Никель сатин



NERO OPACO
Matt black
Noir opaque
Matt schwarz
черный матовый

08

36

23



ME 10 AP

Bicchieri porta spazzolini da appoggio
Leaning brass tooth-brush holder
Porte brosses de dents en laiton d'appui
Zahnbecher freistehend aus Messing
Настольный металлический стакан
cm 6 Ø x 11 H

- 08

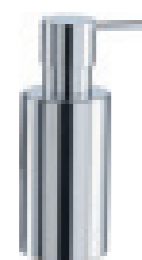

ME 30 AP

Dosatore sapone liquido da appoggio
Leaning brass liquid soap dispenser
Doseur de savon liquid en laiton d'appui
Seifenspender freistehend aus Messing
Настольный металлический дозатор
cm 6 Ø x 16 H

- 08



ME 13

Porta accappatoio
Robe hook
Porte peignoir
Bademantelhaken
Крючок
cm 5 L x 5 P x 4,5 H

- 08 - 23
- 36



ME 808

Porta accappatoio (2 ganci)
Robe hook (2 hooks)
Porte peignoir (2 crochets)
Bademantelhaken (2 Haken)
Крючок гнутый
cm 5,5 L x 5,5 P x 5,5 H

- 08 - 23
- 36



Su richiesta si realizzano aste porta asciugamani su misura, 20 gg

Customized towel rails are available on request, 20 days
Des porte-serviettes personnalisés sont disponibles sur demande, 20 jours
Handtuchhalter sind auf Anfrage erhältlich, 20 Tagen

По запросу мы можем производить полотенцедержатели под размер 20 дней



- 08 - 23 25 → 47 cm
- 08 - 23 49 → 100 cm
- 36 25 → 47 cm
- 36 49 → 100 cm

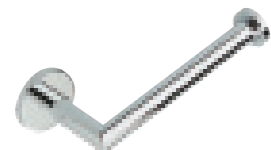

ME 11

Porta rotolo
Paper holder
Porte rouleau
Papierrollenhalter
Бумагодержатель
cm 17 L x 7 P x 4,5 H

- 08 - 23
- 36



ME 11 C

Porta rotolo coperto
Covered paper holder
Porte rouleau avec couvercle
Papierrollenhalter mit Deckel
Бумагодержатель с крышкой
cm 14 L x 12 P x 13 H

- 08 - 23
- 36



ME 11.2

Porta rotolo doppio
Double paper holder
Porte rouleau double
Papierrollenhalter doppelt
Бумагодержатель двойной
cm 26 L x 7 P x 4,5 H

- 08 - 23
- 36



ME 039 M

Porta scopino in ottone a parete
Wall mounted brass toilet-brush
Porte balayent à mur en laiton
Büstengarnitur wandhängend aus Messing
Настенный металлический ёрш
cm 8 L x 9 P x 42 H

- 08 - 23
- 36

Complementi / complements / compléments / ergänzungen / Дополнительно



> pag. 247



> pag. 389



> pag. 315



> pag. 315



> pag. 331



> pag. 350



Les jeux sont faits



MIZAR

Designer: Stilhaus
Materiale: Piatto ottone 15 x 4
Accessori: ceramica bianca
Finiture: 08
Fuori misura: no

Designer: Stilhaus
Material: Solid Brass 15x4
Accessories: white ceramic
Finishes: 08
Customized: no

Designer: Stilhaus
Matériel: Laiton massif 15x4
Accessoires: blanc céramique Finitions: 08
Personnalisé: No

Designer: Stilhaus
Material: Messing bar 15 x 4
Zubehör: weiße Keramik
Ausführungen: 08
Kundenwunsch: Nein

Дизайн: Stil Haus Материал:
латунь Аксессуары: белая
керамика Покрытие: 08 хром
Негабаритный: нет



MZ 09
MZ 10
MZ 30



MZ 05



MZ 69



MZ 11

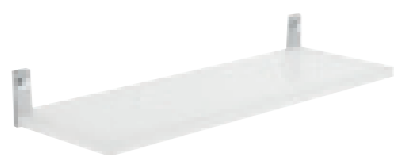

MZ 04

Mensola plexiglass
Shelf
Etagère
Ablage
Полка из оргстекла
cm 60 L x 11 P x 5 H - INT. 58,5

• 08



MZ 05

Asta porta asciugamani
Towel rail
Porte serviettes
Handtuchhalter
Полотенцедержатель
cm 58 L x 8,5 P x 1,5 H - INT. 54

• 08



MZ 45

Asta porta asciugamani
Towel rail
Porte serviettes
Handtuchhalter
Полотенцедержатель
cm 45 L x 8 P x 1,5 H - INT. 40

• 08



MZ 06

Asta porta salviette
Towel rail
Porte serviettes
Handtuchhalter
Полотенцедержатель
cm 28,5 L x 8 P x 1,5 H - INT. 24

• 08



MZ 11

Porta rotolo
Peper holder
Porte rouleau
Papierrollenhalter
Бумагодержатель
cm 17 L x 8 P x 1,5 H

• 08



MZ 11C

Porta rotolo con copercchio
Covered paper holder
Porte rouleau avec couvercle
Papierrollenhalter mit Deckel
Бумагодержатель закрытый
cm 17 L x 9 P x 10 H

• 08



MZ 039

Porta scopino da appoggio
Toilet-brush with base
Porte balayent d'appui
Bürstengarnitur freistehend
Напольный металлический ёрш
cm ø 8 x 44 H

• 08



MZ 039 M

Porta scopino a parete
Wall-mounted toilet-brush
Porte balayent à mur
Bürstengarnitur oval wandhängend
Настенный металлический ёрш
cm ø 8 x 44 H

• 08



MZ 06.1

Asta porta salviette
Towel rail
Porte serviettes
Handtuchhalter
Полотенцедержатель
cm 27 L x 8 P x 1,5 H

• 08



MZ 69

Porta salviette con porta sapone
Serviettes holder with soap dish
Porte serviettes avec porte savon
Handtuchhalter mit Seifenschale
Полотенцедержатель + керамическая
мыльница
cm 29 L x 8 P x 4 H

• 08



MZ 69 D

Porta salviette con dosatore sapone
Serviettes holder with soap dispenser
Porte serviettes avec doseur de savon
Handtuchhalter mit Seifenspender
Настенная керамическая мыльница
дозатор
cm 27 L x 8 P x 18 H

• 08



MZ 09

Porta sapone a parete
Wall mounted ceramic soap dish
Porte savon à mur en céramique
Seifenschale wandhängend aus Keramik
cm 11,5 L x 7 P x 4 H

• 08



1076

Mensola plexiglass con asta porta asciugamani
Shelf with towel rail
Entragerè avec porte serviettes
Ablage mit Handtuchhalter
Полка из оргстекла с
полотенцедержателем
cm 26 L x 11 P x 13 H - INT. 24,5

• 08



1077

Mensola plexiglass con asta porta asciugamani
Shelf with towel rail
Entragerè avec porte serviettes
Ablage mit Handtuchhalter
Полка из оргстекла с
полотенцедержателем
cm 40 L x 11 P x 13 H - INT. 28,5

• 08



MZ 10

Porta bicchiere a parete
Wall mounted ceramic glass holder
Porte verre à mur en céramique
Zahnbürstenhalter wandhängend aus Keramik
Настенный керамический стакан
cm 8 L x 8 P x 12 H

• 08



MZ 30

Porta dosatore sapone liquido in ceramica
Ceramic liquid soap dispenser holder
Doseur de savon liquid en céramique
Seifenspender aus Keramik
Настенный керамический дозатор
cm 8 L x 8 P x 18 H

• 08



MZ 14

Porta sapone con Porta bicchiere
Soap dish + Glass holder
Porte savon + Porte verre
Seifenschale + Zahnbürstenhalter freistehend
Настольные керамический
cm 16 L x 8 P x 18 H

• 08



MZ 13.2

Porta accappatoio (2 ganci)
Robe hook (2 hooks)
Porte peignoir (2 crochets)
Bademantelhaken (2 Haken)
Крючок
cm 2 L x 3,5 P x 9 H

• 08

Complementi / complements / compléments / ergänzungen / Дополнительно



> pag. 260



> pag. 284



> pag. 379



> pag. 379



> pag. 378



> pag. 378



> pag. 378

Origine della funzione



QUID

Designer: Claudio Papa
Materiale: Ottone barra 12, basetta a muro 30x40
Accessori: Vetro satinato
Finitura: 08
Fuori misura: No
Incollo : Si

Designer: Claudio Papa
Material: Brass Bar 12, fixing plate cover 30x40
Accessories: Frosted glass
Finishes: 08
Customized: No
By glue : Yes

Designer: Claudio Papa
Matériel: laiton massif Bar 12, boucle couvre-vis 30x40
Accessoires: Verre satin
Finitions: 08
Personnalisé: Non
Par collage : Oui

Designer: Claudio Papa
Material: Messing bar 12, Angriff 30x40
Zubehör: Mattglas
Ausführungen: 08
Kundenspezifische: Nein
Kleber: Ja

Дизайн: Claudio Papa Материал: латунь ø 12, 30x40 Аксессуары: сатинированное стекло Отделка: 08 хром Негабаритный: да Установка на клей: да

Q 69



Q 13



Q 10



Q 11
Q 12



Q 04

Mensola vetro satinato 8 mm
Shelf
Étagère
Ablage
Стеклопанельная полка – толщина стекла 8mm
cm 60 L x 10 P x 8 H - INT. 50

• 08



Q 05

Asta porta asciugamani
Towel rail
Porte serviettes
Handtuchhalter
Полотенцедержатель
cm 60 L x 7 P x 7,5 H - INT. 55

• 08



Q 45

Asta porta asciugamani
Towel rail
Porte serviettes
Handtuchhalter
Полотенцедержатель
cm 45 L x 7 P x 7,5 H - INT. 40,5

• 08



Q 06

Asta porta salviette
Towel rail
Porte serviettes
Handtuchhalter
Полотенцедержатель
cm 30 L x 7 P x 7,5 H - INT. 25

• 08



Q 16

Porta asciugamani snodo 2 aste
Towel rail with 2 adjustable bar
Porte serviettes à 2 barres orientables
Handtuchhalter schwenkbar 2 Stangen
Полотенцедержатель двойной поворотный
cm 5 L x 32 P x 14 H

• 08



Q 69

Porta salviette con porta sapone
Serviettes holder with soap dish
Porte serviettes avec porte savon
Handtuchhalter mit Seifenschale
Полотенцедержатель + стеклянная
мыльница
cm 40 L x 12 P x 8 H

• 08

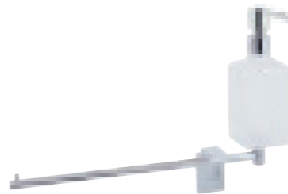

Q 69 D

Porta salviette con dosatore sapone
Towel rail with liquid soap dispenser
Porte serviettes avec doseur de savon
Handtuchhalter mit Seifenspender
Полотенцедержатель + стеклянный
дозатор
cm 40 L x 12 P x 24 H

• 08



Q 69.2

Portasciugamani con porta sapone e porta rotolo
Towel holder with soap dish and paper holder
Porte serviettes avec porte savon et porte rouleau
Handtuchhalter mit Seifenschale und Papierrollenhalter
Полотенцедержатель + стеклянная
мыльница + бумагодержатель
cm 54 L x 12 P x 8 H - INT. 30,5

• 08



Q 69.2 D

Portasciugamani con dosatore e porta rotolo
Towel holder with soap dispenser and paper holder
Porte serviettes avec doseur de savon et porte rouleau
Handtuchhalter mit Seifenspender und Papierrollenhalter
Полотенцедержатель + стеклянный дозатор
+ бумагодержатель
cm 54 L x 12 P x 24 H - INT. 30,5

• 08



Q 09

Porta sapone a parete
Wall mounted ceramic soap dish
Porte savon à mur en céramique
Seifenschale wandhängend aus Keramik
Настенная керамическая мыльница
cm 10 L x 11 P x 11 H

• 08



Q 10

Porta bicchiere a parete
Wall mounted ceramic glass holder
Porte verre à mur en céramique
Zahnbürstenhalter wandhängend aus Keramik
Настенный керамический стакан
cm 7 L x 10 P x 13,5 H

• 08



Q 30

Dosatore sapone liquido a parete
Wall-mounted soap dispenser
Doseur de savon
Seifenspender
Настенный стеклянный дозатор
cm 7 L x 10 P x 19 H

• 08



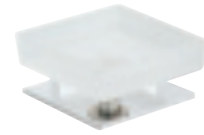

Q 09 AP

Porta sapone da appoggio
 Soap dish with base
 Porte savon d'appui
 Seifenschale freistehend
 Настольная стеклянная мыльница
 cm 10 L x 10 P x 4 H

• 08



Q 10 AP

Porta bicchiere da appoggio
 Glass holder with base
 Porte verre d'appui
 Zahnbürstenhalter freistehend
 Настольный стеклянный стакан
 cm 9 L x 9 P x 12 H

• 08



Q 30 AP

Dosatore sapone da appoggio
 Soap dispenser with base
 Doseur de savon d'appui
 Seifenspender freistehend
 Настольный стеклянный дозатор
 cm 9 L x 9 P x 19 H

• 08



Q 13

Porta accappatoio (2 ganci)
 Robe hook (2 hooks)
 Porte peignoir (2 crochets)
 Bademantelhaken (2 Haken)
 Крючок
 cm 10 L x 7 P x 8 H

• 08



Q 11

Porta rotolo
 Paper holder
 Porte rouleau
 Papierrollenhalter
 Бумагодержатель
 cm 17 L x 7 P x 7,5 H

• 08



Q 12

Porta scopino a parete
 Wall mounted toilet-brush
 Porte balayent à mur
 Bürstengarnitur wandhängend
 Настенный стеклянный ёрш
 cm 9 L x 14 P x 35 H

• 08



Q 039 M

Porta scopino a parete
 Wall mounted oiler-brush
 Porte balayent à mur
 Bürstengarnitur wandhängend
 Настенный металлический ёрш
 cm 8,5 L x 9 P x 35 H

• 08



Q 039

Porta scopino da appoggio
 Toilet-brush with base
 Porte balayent d'appui
 Bürstengarnitur freistehend
 Напольный металлический ёрш
 cm 8 L x 8 P x H 35

• 08



Q 69.2



840

Kit collante e biadesivo per un articolo
 Kit with bi-adhesive and glue for one article
 Kit avec collant et biadhésif pour un article
 Klebekit ist ein beidseitiger Klebestreifen
 Клей

• 08

Complementi / complements / compléments / ergänzungen / Дополнительно



> pag. 252



> pag. 283



> pag. 311



> pag. 311



> pag. 329



> pag. 350



Prospettiva naturale



SATURNINO

Designer: STILHAUS
Materiale: Barra Inox 304,
Accessori: vetro satinato
Finitura: 54
Fuori misura: si

Designer: STILHAUS
Material: Barra Inox 304
Accessories: Frosted Glass
Finishes: 54
Customized: si

Designer: STILHAUS
Matériau: Bar d'acier 304
Accessoires: Verre satin
Finitions: 54
Personnalisé: Si

Designer: STILHAUS
Material: Stahl Bar 304
Zubehör: Milchglas
Ausführungen: 54
Kundenwunsch: Ja

Дизайн: Stil Haus Материал:
нержавеющая сталь Аксессуары:
сатинированное стеклоПокрyтие:
54 сатинированная сталь
Негабаритный: да



ST 10
ST 30

ST 45



ST 11

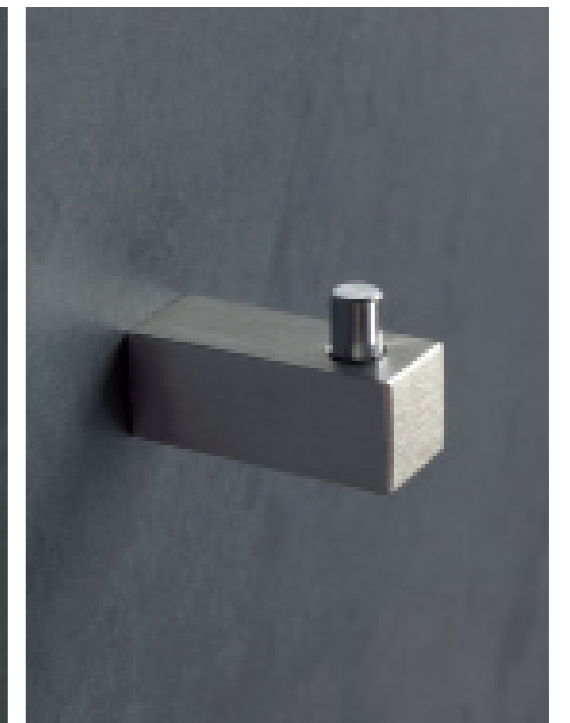

ST 13



ST 04

Mensola con plexiglass satinato
Shelf
Étagère
Ablage
Полка из оргстекла
cm 60 L x 11 P x 2 H

• 54



ST 05

Asta porta asciugamani
Towel rail
Porte serviettes
Handtuchhalter
Полотенцедержатель
cm 58 L x 7 P x 1,5 H - INT. 58

• 54



ST 45

Asta porta asciugamani
Towel rail
Porte serviettes
Handtuchhalter
Полотенцедержатель
cm 45 L x 7 P x 1,5 H - INT. 43

• 54



ST 06

Asta porta salviette
Towel rail
Porte serviettes
Handtuchhalter
Полотенцедержатель
cm 32 L x 7 P x 1,5 H - INT. 28

• 54



ST 039 M

Porta scopino a parete
Wall mounted toilet-brush
Porte balayent à mur
Bürostengarnitur wandhängend
Настенный металлический ёрш
cm ø 8 x 38 H

• 54



ST 17

Mensola con plexiglass satinato
Shelf
Étagère
Ablage
Полка из оргстекла
cm 32 L x 11 P x 2 H

• 54



ST 16

Porta asciugamani snodo 2 aste
Towel rail with 2 adjustable bar
Porte serviettes à 2 barres orientables
Handtuchhalter schwenkbar 2 Stangen
Полотенцедержатель двойной поворотный
cm 3 L x 33 P x 8 H

• 54

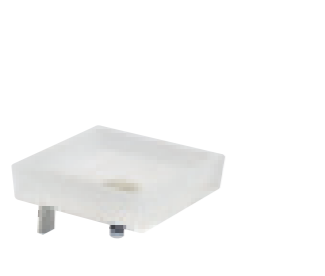

ST 09

Porta sapone a parete
Wall mounted ceramic soap dish
Porte savon à mur en céramique
Seifenschale wandhängend aus Keramik
Настенная керамическая мыльница
cm 10,5 L x 11 P x 6 H

• 54



ST 10

Porta bicchiere a parete
Wall mounted ceramic glass holder
Porte verre à mur en céramique
Zahnbürstenhalter wandhängend aus Keramik
Настенный керамический стакан
cm 7 L x 9 P x 13 H

• 54



ST 30

Dosatore sapone liquido a parete
Wall-mounted soap dispenser
Doseur de savon
Seifenspender
Настенный стеклянный дозатор
cm 7 L x 9 P x 22 H

• 54



Su richiesta si realizzano aste porta asciugamani su misura, 5 gg

Customized towel rails are available on request, 5 days

Des porte-serviettes personnalisés sont disponibles sur demande, 5 jours

Handtuchhalter sind auf Anfrage erhältlich, 5 Tagen

По запросу мы можем производить полотенцедержатели под размер 5 дней



• 08 25 → 44 cm

• 08 46 → 80 cm



ST 13

Porta accappatoio
Robe hook
Porte peignoir
Bademantelhaken
Крючок
cm 1,5 L x 3,5 P x 2,5 H

• 54



ST 11

Porta rotolo
Paper holder
Porte rouleau
Papierrollenhalter
Бумагодержатель
cm 16 L x 7 P x 4 H

• 54



1005

Porta rotolo con coperchio
Covered paper holder
Porte rouleau avec couvercle
Papierrollenhalter mit Deckel
Бумагодержатель с крышкой
cm 12 L x 13 P x 6 H

• 54



ST 039

Porta scopino da appoggio
Ceramic toilet-brush with base
Porte balayent en céramique d'appui
Bürostengarnitur freistehend
Напольный металлический ёрш
cm ø 8 x 38 H

• 54



ST 17

Sistema d'ingegno



URANIA

Designer: Stilhaus
Materiale: Ottone, tubo 12x12, basetta a muro 50x50
Accessori: Ceramica bianca
Finitura: 08-36-23
Fuori misura: Sì
Incollo: Sì

Designer: Stilhaus
Material: Brass tube 12x12, fixing plate cover 50x50
Accessories: White ceramic
Finishes: 08-36-23
Customized: Yes
By glue: Yes

Designer: Stilhaus
Matière: Laiton, tuyau 12x12, boucle couvre-vis 50x50
Accessoires: Blanc céramique
Finitions: 08-36-23
Personnalisé: Oui
Par collage: Oui

Designer: Stilhaus
Material: Messing Rohr 12x12, Befestigungsplatten Oberfläche 50x50
Zubehör: Weiße Keramik
Ausführungen: 08-36-23
Kundenwunsch: Ja
Kleber: Ja

Дизайн: Stilhaus **Материал:** латунь сатин 12x12, 50x50
Аксессуары: белая керамика
Отделка: 08 , 36 , 23
Негабаритный: да **Установка на клей:** да

U 039 M

U 06.2

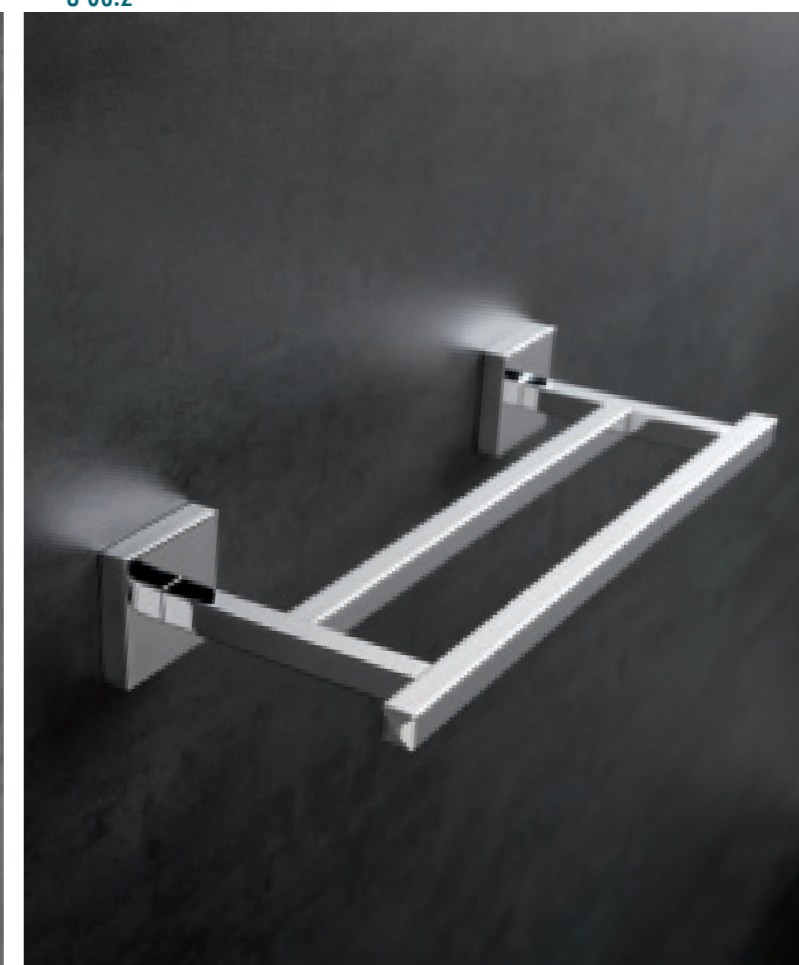

U 13

U 30
U 04

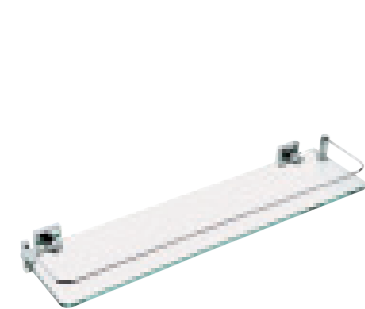

U 04

Mensola vetro 8mm

Shelf
Étagère
Ablage

ограждением – толщина стекла 8 мм
cm 60 L x 12 P x 8 H

- 08 - 23
- 36



U 05

Asta porta asciugamani

Towel rail
Porte serviettes
Handtuchhalter

Полотенцедержатель
cm 60,5 L x 7,5 P x 5 H x INT. 55,5

- 08 - 23
- 36



U 05.2

Porta asciugamani doppia asta

Double towel rail
Porte serviettes avec 2 bars
Handtuchstange doppelt

Полотенцедержатель двойной
cm 60,5 L x 11 P x 5 H x INT. 55,5

- 08 - 23
- 36



U 45

Asta porta asciugamani

Towel rail
Porte serviettes
Handtuchhalter

Полотенцедержатель
cm 45,5 L x 7,5 P x 5 H x INT. 40,5

- 08 - 23
- 36



U 06

Asta porta salviette

Towel rail
Porte serviettes
Handtuchhalter

Полотенцедержатель
cm 30,5 L x 7,5 P x 5 H - INT. 25,3

- 08 - 23
- 36



U 06.2

Porta salviette doppia asta

Double towel rail
Porte serviettes avec 2 bars
Handtuchstange doppelt

Полотенцедержатель двойной
cm 30,5 L x 11 P x 5 H x INT. 25,3

- 08 - 23
- 36

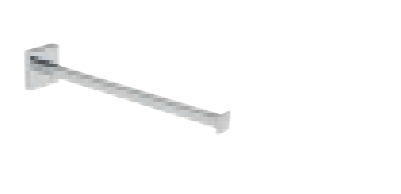

U 06.1

Asta porta salviette

Towel rail
Porte serviettes
Handtuchhalter

Полотенцедержатель
cm 5 L x 26 P x 5 H

- 08 - 23
- 36



U 16

Porta asciugamani snodo 2 aste

Towel rail with 2 adjustable bar
Porte serviettes à 2 barres orientables
Handtuchhalter schwenkbar 2 Stangen

Полотенцедержатель двойной поворотный
cm 5 L x 33 P x 8 H

- 08 - 23
- 36



U 07

Anello porta salviette

Ring serviette
Porte serviettes à anneau
Handtuchring

Полотенцедержатель – кольцо
cm 22,5 Ø x 5,5 P x 24 H

- 08 - 23
- 36

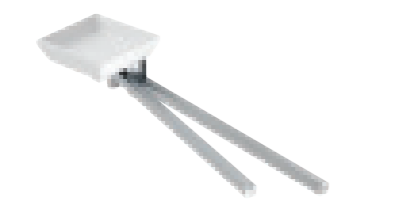

U 18

Porta asciugamani snodo con porta sapone

Towel rail 2 adjustable bar with soap dish
Porte serviettes à 2 barres orientables avec porte savon
Handtuchhalter schwenkbar mit Seifenschale

Полотенцедержатель двойной поворотный + керамическая мыльница
cm 5 L x 32 P x 10 H

- 08 - 23
- 36



U 18 D

Porta asciugamani snodo con dosatore sapone

Towel rail 2 adjustable bar with soap dispenser
Porte serviettes à 2 barres orientables avec doseur savon
Handtuchhalter schwenkbar mit Seifenspender

Полотенцедержатель двойной поворотный + керамический дозатор
cm 7 L x 32 P x 24 H

- 08 - 23
- 36



U 69

Porta salviette con porta sapone

Serviettes holder with soap dish
Porte serviettes avec porte savon
Handtuchhalter mit Seifenschale

Полотенцедержатель + керамическая мыльница
cm 39 L x 11 P x 7,5 H - INT. 27

- 08 - 23
- 36



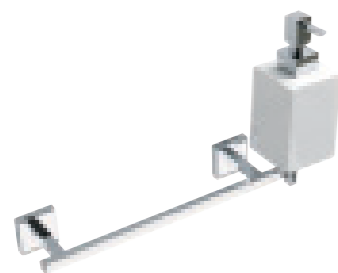

U 69 D

Porta salviette con dosatore sapone
Serviettes holder with soap dispenser
 Porte serviettes avec doseur de savon
Handtuchhalter mit Seifenspender
 Полотенцедержатель + керамический дозатор
 cm 39 L x 11 P x 20,5 H - INT. 25

- 08 - 23
- 36



U 09

Porta sapone a parete
Wall mounted ceramic soap dish
 Porte savon à mur en céramique
Seifenschale wandhängend aus Keramik
 Настенная керамическая мыльница
 cm 10 L x 11 P x 7,5 H

- 08 - 23
- 36



U 10

Porta bicchiere a parete
Wall mounted ceramic glass holder
 Porte verre à mur en céramique
Zahnbürstenhalter wandhängend aus Keramik
 Настенный керамический стакан
 cm 7,5 L x 10 P x 15 H

- 08 - 23
- 36



U 14

Porta sapone con Porta bicchiere a parete
Wall mounted soap dish + Glass holder
 Porte savon + Porte verre à mur
Seifenschale + Zahnbürstenhalter wandhängend
 Настенные керамические стакан + мыльница
 cm 20 L x 11 P x 15 H

- 08 - 23
- 36



U 11 C

Porta rotolo con coperchio
Covered paper holder
 Porte rouleau avec couvercle
Papierrollenhalter mit Deckel
 Бумагодержатель закрытый
 cm 13 L x 15 P x 12 H

- 08 - 23
- 36



U 039 M

Porta scopino a parete
Wall mounted toilet-brush
 Porte balayent à mur
Bürstengarnitur wandhängend
 Настенный металлический ёрш
 cm 8 L x 9 P x 40 H

- 08 - 23
- 36



U 039 Q

Porta scopino da appoggio
Toilet-brush with base
 Porte balayent d'appui
Bürstengarnitur freistehend
 Напольный металлический ёрш
 cm 8 L x 9 P x 40 H

- 08 - 23
- 36



633 CUBE

Porta scopino in ceramica
Ceramic Toilet-brush
 Porte balayent en ceramique
Bürstengarnitur wandhängend
 Напольный керамический ёрш
 cm 10 L x 10 P x 38 H

- 08 - 23
- 36



U 14 D

Dosatore con Porta bicchiere a parete
Wall mounted soap dispenser + Glass holder
 Porte savon liquid + Porte verre à mur
Seifenspender + Zahnbürstenhalter wandhängend
 Настенные керамические стакан + дозатор
 cm 19 L x 10 P x 22 H

- 08 - 23
- 36



U 30

Dosatore sapone liquido a parete
Wall-mounted soap dispenser
 Doseur de savon
Seifenspender
 Настенный стеклянный дозатор
 cm 7,5 L x 10 P x 23 H

- 08 - 23
- 36



616

Porta sapone da appoggio
Soap dish with base
 Porte savon d'appui
Seifenschale
 Настольная керамическая мыльница
 cm 10 L x 10 P x 5 H

- 08 - 23
- 36



617

Bicchieri d'appoggio
Glass with base
 Verre base
Zahnputzbecher
 Настольный керамический стакан
 cm 9 L x 9 P x 12 H

- 08 - 23
- 36



840

Kit collante e biadesivo per un articolo
Kit with bi-adhesive and glue for one article
 Kit avec collant et biadhésif pour un article
Klebekit ist ein beidseitiger Klebestreifen
 Возможность установки на клей.Ыфдгеш

FINITURA

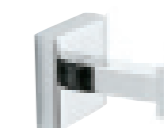

CROMO
 Chrome
 Chrome
 Chrom
 хром



NERO OPACO
 Matt black
 Noir opaque
 Matt schwarz
 черный матовый

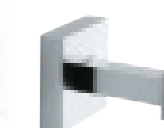

NICHEL SATINATO
 Satin nickel
 Nickel satiné
 Nickel satiniert
 Никель сатин

08

23

36



618

Dosatore sapone liquido da appoggio
Soap dispenser with base
 Doseur de savon d'appui
Seifenspender
 Настольный керамический дозатор
 cm 9 L x 9 P x 19 H

- 08 - 23
- 36

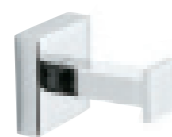

U 13

Porta accappatoio
Robe hook
 Porte peignoir
Bademantelhaken
 Крючок
 cm 5 L x 4,5 P x 5 H

- 08 - 23
- 36

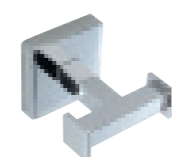

U 13.2

Porta accappatoio (2 ganci)
Robe hook (2 hooks)
 Porte peignoir (2 peignoir)
Bademantelhaken (2 Haken)
 Крючок двойной
 cm 8 L x 7,5 P x 5 H

- 08 - 23
- 36



U 11

Porta rotolo
Peper holder
 Porte rouleau
Papierrollenhalter
 Бумагодержатель
 cm 16,5 L x 7,5 P x 5 H

- 08 - 23
- 36

Su richiesta si realizzano aste porta asciugamani su misura, 20 gg
Customized towel rails are available on request, 20 days
 Des porte-serviettes personnalisés sont disponibles sur demande, 20 jours
 Handtuchhalter sind auf Anfrage erhältlich, 20 Tagen
 По запросу мы можем производить полотенцедержатели под размер 20 дней



• 08 - 23	25 → 44 cm	€ 108,00
• 08 - 23	46 → 90 cm	€ 109,00
• 36	25 → 44 cm	€ 132,00
• 36	46 → 90 cm	€ 145,00

Complementi / complements / compléments / ergänzungen / Дополнительно



> pag. 252



> pag. 284



> pag. 239



> pag. 389



> pag. 312



> pag. 355



> pag. 312



> pag. 350



Start e stop



VENUS

Designer: Stilhaus
Materiale: ottone, tubo Ø10, basetta a muro Ø 50
Accessori: Vetro Satinato
Finitura: 08
Fuori misura: Sì - Interasse regolabile
Incollo : Sì

Designer: Stilhaus
Material: Brass tube Ø 10, fixing plate cover Ø 50
Accessories: Frosted glass
Finishes: 08
Customized: Yes - Adjustable wheelbase
By glue : Yes

Designer: Stilhaus
Matière: Laiton, tuyau Ø10, boucle couvre-vis Ø50
Accessoires: Verre satin
Finitions: 08
Personnalisé: Oui - Empattement réglable
Par collage : Oui

Designer: Stilhaus
Material: Messing Rohr Ø 10, Befestigungsplatten Oberfläche Ø50
Zubehör: Mattglas
Ausführungen: 08
Kundenwunsch: Ja - einstellbaren Abstand
Kleber: Ja

Дизайн: Stilhaus Материал: латунь ø 10, ø 50 Аксессуары: сатинированное стекло Отделка: 08 хром Негабаритный: да Установка на клей: да



VE 45.2

VE 16



VE11- VE 12



VE 10



VE 04

Mensola
Shelf
Étagère
Ablage
Стеклоянная полка
cm 60 L x 12 P x 5 H

•08



VE 05

Asta porta asciugamani
Towel rail
Porte serviettes
Handtuchhalter
Полотенцедержатель
cm 60 L x 7 P x 5 H INT. 55

•08



VE 05.2

Porta asciugamani doppia asta
Double towel rail
Porte serviettes avec 2 bars
Handtuchstange doppelt
Полотенцедержатель двойной
cm 60 L x 10,5 P x 5 H - INT. 55

•08



VE 45

Asta porta asciugamani
Towel rail
Porte serviettes
Handtuchhalter
Полотенцедержатель
cm 45 L x 7 P x 5 H - INT. 40

•08



VE 45.2

Porta asciugamani doppia asta
Double towel rail
Porte serviettes avec 2 bars
Handtuchstange doppelt
Полотенцедержатель двойной
cm 45 L x 10,5 P x 5 H INT. 40

•08



VE 06

Asta porta salviette
Towel rail
Porte serviettes
Handtuchhalter
Полотенцедержатель
cm 30 L x 7 P x 5 H - INT. 25

•08

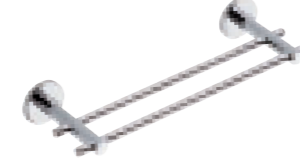

VE 60.2

Porta salviette doppia asta
Towel rail 2 bars
Porte serviettes avec 2 bars
Handtuchstange doppelt
Полотенцедержатель двойной
cm 30 L x 10,5 P x 5 H - INT. 25

•08



VE 16

Porta asciugamani 2 aste
Towel rail with 2 adjustable bar
Porte serviettes à 2 barres orientables
Handtuchhalter schwenkbar 2 Stangen
Полотенцедержатель двойной поворотный
cm 34,5 L x 4,5 P x 8 H

•08



VE 69

Porta salviette con porta sapone
Towel rail with soap dish
Porte serviettes avec porte savon
Handtuchhalter mit Seifenschale
Полотенцедержатель + стеклянная мыльница
cm 41 L x 7 P x 5 H - INT. 25

•08



VE 07

Anello porta salviette
Ring serviette holder
Porte serviettes à anneau
Handtuchring
Полотенцедержатель - кольцо
cm 21 L x 7,5 P x 22 H

•08



VE 09

Porta sapone a parete
Wall mounted soap dish
Porte savon à mur
Seifenschale wandhängend
Настенная стеклянная мыльница
cm 10,5 L x 11 P x 5 H

•08



VE 10

Porta bicchiere a parete
Wall mounted glass holder
Porte verre à mur
Zahnbrüstenhalter wandhängend
Настенный стеклянный стакан
cm 7,5 L x 9 P x 14 H

•08





VE 30

Dosatore sapone liquido a parete
Wall-mounted soap dispenser
Doseur de savon
Seifenspender
Настенный стеклянный дозатор
cm 5,5 L x 9 P x 21,5 H

•08



VE 13

Porta accappatoio
Robe hook
Porte peignoir
Bademantelhaken
Крючок
cm 2 L x 4 P x 2 H

•08



VE 809

Porta accappatoio (2 ganci)
Robe hook (2 hooks)
Porte peignoir (2 peignoir)
Bademantelhaken (2 Haken)
Крючок двойной
cm 5,5 L x 5,5 P x 5,5 H

•08



VE 13.3

Porta accappatoio (3 ganci)
Robe hook (3 hooks)
Porte peignoir (3 crochets)
Bademantelhaken (3 Haken)
Крючок тройной
cm 15 L x 4 P x 2 H

•08



VE 11

Porta rotolo
Paper holder
Porte rouleau
Papierrollenhalter
Бумагодержатель с крышкой
cm 21 L x 7,5 P x 5 H

•08



VE 11 C

Porta rotolo coperto
Covered paper holder
Porte rouleau avec couvercle
Papierrollenhalter mit Deckel
Бумагодержатель с крышкой
cm 21 L x 12 P x 12 H

•08



VE 11 S

Porta rotolo di scorta
Paper holder of supply
Porte rouleau d'escorte
Ersatzpapierrollenhalter
Настенный вертикальный бумагодержатель
cm 12 L x 9 P x 21 H

•08



898

Porta rotolo da appoggio
Paper holder stand
Porte rouleau d'appui
Papierrollenhalter freistehend
Бумагодержатель настольный вертикальный
cm 10 Ø x 14 H

•08



VE 11 C



Su richiesta si realizzano aste porta asciugamani su misura, 10 gg
Customized towel rails are available on request, 10 days
Des porte-serviettes personnalisés sont disponibles sur demande, 10 jours
Handtuchhalter sind auf Anfrage erhältlich, 10 Tagen
По запросу мы можем производить полотенцедержатели под размер 10 дней



•08 25 → 44 cm
•08 46 → 90 cm



899

Porta rotolo di scorta da appoggio
Paper holder of supply stand
Porte rouleau d'escorte d'appui
Ersatzpapierrollenhalter freistehend
Бумагодержатель напольный вертикальный
cm 10 Ø x 39 H

•08



VE 12

Porta scopino a parete con manico telescopico Pratico
Wall mounted toilet-brush with telescopic handle
Porte balaynet à mur avec poignée télescopique
Bürstengarnitur wandhängend mit Teleskopgriff
Настенный стеклянный ёрш
cm 9 L x 12 P x 48 H

•08



VE 039 PRATIKO

Porta scopino da appoggio con manico telescopico
Toilet-brush with telescopic handle
Porte balaynet d'appui avec poignée télescopique
Bürstengarnitur freistehend mit Teleskopgriff
Напольный металлический ёрш
cm 12 L x 12 P x 52,5 H

•08



840

Kit collante e biadesivo per un articolo
Kit with bi-adhesive and glue for one article
Kit avec collant et biadhésif pour un article
Klebekit ist ein beidseitiger Klebestreifen
Клей

•08

Complementi / complements / compléments / ergänzungen / Дополнительно

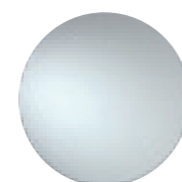

> pag. 254



> pag. 285



> pag. 389



> pag. 318



> pag. 318



> pag. 318



> pag. 350



L'essenza della forma



ZEFIRO

Designer: Claudio Papa
Materiale: Ottone barra Ø 10, basetta a muro 50x35
Accessori: Ceramica
Finitura: 08
Fuori misura: No

Designer: Claudio Papa
Material: Solid Brass Bar Ø 10, fixing plate cover 50x35
Accessories: Ceramic
Finishes: 08
Customized: No

Designer: Claudio Papa
Matiérielle: Laiton massif Ø 10, boucle couvre-vis 50x35
Accessoires: Céramique
Finitions: 08
Personnalisé: No

Designer: Claudio Papa
Material: Messing bar Ø 10, Befestigungsplatten Oberfläche 50x35
Zubehör: Weiße Keramik
Ausführungen: 08
Kundenwunsch: Nein

Дизайн: Claudio Papa Материал: латунь Ø 10, 50x35 Аксессуары: керамика Отделка: 08 хром Негабаритный: нет

ZE 45



ZE 13



ZE 11



ZE 30
ZE 10
ZE 09



ZE 04

Mensola vetro 8 mm satinato
Shelf
Étagère
Ablage
Стеклоянная полка – толщина стекла 8mm
cm 60 L x 13 P x 8 H - INT. 50

• 08



ZE 05

Asta porta asciugamani
Towel rail
Porte serviettes
Handtuchhalter
Полотенцедержатель
cm 60 L x 7,5 P x 6 H INT 55,7

• 08



ZE 45

Asta porta asciugamani
Towel rail
Porte serviettes
Handtuchhalter
Полотенцедержатель
cm 45 L x 7,5 P x 6 H INT 40,8

• 08



ZE 06

Asta porta salviette
Towel rail
Porte serviettes
Handtuchhalter
Полотенцедержатель
cm 34 L x 7,5 P x 6 H x INT 29,8

• 08



ZE 13

Porta accappatoio (2 ganci)
Robe hook (2 hooks)
Porte peignoir (2 crochets)
Bademantelhaken (2 Haken)
Крючок
cm 7 L x 9 P x 10 H

• 08

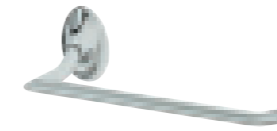

ZE 11

Porta rotolo
Paper holder
Porte rouleau
Papierrollenhalter
Бумагодержатель
cm 17 L x 8 P x 6 H

• 08



646 ZEFIRO

Porta scopino in ceramica
Ceramic Toilet-brush
Porte balaynet en ceramique
Bürstengarnitur wandhängend
Напольный керамический ёрш
cm 14 L x 14 P x 42 H

• 08 bianco / white / blanc / weiß / белый
• 08 colorato / colored / coloré / farbig / цветной



ZE 16

Porta asciugamani snodo a 2 aste
Towel rail with 2 adjustable bar
Porte serviettes à 2 barres orientables
Handtuchhalter schwenkbar 2 Stangen
Полотенцедержатель двойной поворотный
cm 3 L x 33 P x 8 H

• 08



ZE 07

Anello porta salviette
Ring serviette holder
Porte serviettes à anneau
Handtuchring
Полотенцедержатель – кольцо
cm 21 L x 9 P x 21 H

• 08



ZE 09

Porta sapone a parete
Wall mounted soap dish
Porte savon à mur
Seifenschale wandhängend
Настенная керамическая мыльница
cm 13 L x 11 P x 9 H

• 08 bianco / white / blanc / weiß / белый
• 08 colorato / colored / coloré / farbig / цветной



ZE 10

Porta bicchiere a parete
Wall mounted glass holder
Porte verre à mur
Zahnbrüstenhalter wandhängend
Настенный керамический стакан
cm 1,5 L x 3,5 P x 2,5 H

• 08 bianco / white / blanc / weiß / белый
• 08 colorato / colored / coloré / farbig / цветной



08-BI

CROMO - CER. BIANCO
Chrome - Cer. white
Chrome - Cér. blanc
Chrom - Ker. weiß
хром – белая керамика



08-VE

CROMO - CER. VERDE
Chrome - Cer. green
Chrome - Cér. vert
Chrom - Ker. grün
хром – зеленая керамика



08-RO

CROMO - CER. ROSSO
Chrome - Cer. red
Chrome - Cér. rouge
Chrom - Ker. rot
хром – красная керамика



08-AR

CROMO - CER. ARANCIO
Chrome - Cer. orange
Chrome - Cér. orangier
Chrom - Ker. orange
хром – оранжевая керамика



08-NE

CROMO - CER. NERO
Chrome - Cer. black
Chrome - Cér. noir
Chrom - Ker. schwarz
хром – черная керамика



08-LI

CROMO - CER. LILLA
Chrome - Cer. lilac
Chrome - Cér. lilie
Chrom - Ker. lila
хром – лиловая керамика



ZE 30

Dosatore sapone liquido a parete
Wall mounted soap dispenser
Doseur de savon à mur
Seifenspender wandhängend
Настенный керамический дозатор
cm 10 L x 9 P x 25 H

• 08 bianco / white / blanc / weiß / белый
• 08 colorato / colored / coloré / farbig / цветной



652

Porta sapone da appoggio
Soap dish with base
Porte savon d'appui
Seifenschale freistehend
Настольная керамическая мыльница
cm 13 L x 8 P x 2 H

• 08 bianco / white / blanc / weiß / белый
• 08 colorato / colored / coloré / farbig / цветной



653

Bicchiere da appoggio
Glass with base
Verre d'appui
Zahnputzbecher freistehend
Настольный керамический стакан
cm 10 L x 7 P x 10 H

• 08 bianco / white / blanc / weiß / белый
• 08 colorato / colored / coloré / farbig / цветной



654

Dosatore sapone d'appoggio
Soap dispenser with base
Porte savon d'appui
Seifenspender freistehend
Настольный керамический дозатор
cm 10 L x 7 P x 19 H

• 08 bianco / white / blanc / weiß / белый
• 08 colorato / colored / coloré / farbig / цветной

Complementi / complements / compléments / ergänzungen / Дополнительно



> pag. 264



> pag. 287



> pag. 310



> pag. 310



> pag. 310



> pag. 358

Il bello chiama



ELITE

Designer: Stilhaus
Materiale: ottone, Tubo Ø 16, basetta a muro Ø 50
Accessori: Vetro satinato
Finitura: 08-02-16-25-26-36
Fuori misura: Sì
Incollo: Sì

Designer: Stilhaus
Material: Brass tube Ø 16, fixing plate cover Ø 50
Accessories: Frosted glass
Finishes: 08-02-16-25-26-36
Customized: Yes
By glue: Yes

Designer: Stilhaus
Matière: Laiton, tuyau Ø 16, boucle couvre-vis Ø 50
Accessoires: Verre satin
Finitions: 08-02-16-25-26-36
Personnalisé: Oui
Par collage: Oui

Designer: Stilhaus
Material: Messing Rohr Ø 16, Befestigungsplatten Oberfläche Ø 50
Zubehör: Mattglas
Ausführungen: 08-02-16-25-26-36
Kundenwunsch: Ja
Kleber: Ja

Дизайн: Stilhaus Материал: латунь Ø 16, Ø 50 Аксессуары: матовое стекло Отделка: 08-02-16-25-26-36 Негабаритный: да Установка на клей: да



EL 06

EL 69 D



EL 11

EL 07



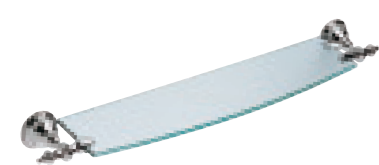

EL 04

Mensola vetro 8mm
Shelf
Étagère
Ablage

Стеклоплатформа – толщина стекла 8 мм
cm 70 L x 13 P x 6 H - INT. 61,5

- 08
- 02
- 16 - 25 - 26 - 36

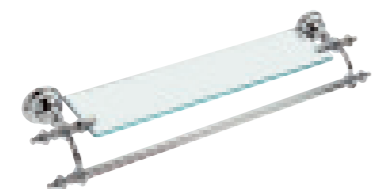

EL 33

Mensola + porta asciugamani
Shelf + towel rail
Étagère + porte serviette
Ablage + Handtuchhalter

Стеклоплатформа + полотенцедержатель
cm 61 L x 15 P x 7 H - INT. 40

- 08
- 02
- 16 - 25 - 26 - 36

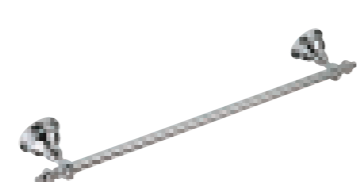

EL 05

Asta porta asciugamani
Towel rail
Porte serviette
Handtuchhalter

Полотенцедержатель
cm 61 L x 9 P x 6 H - INT. 51

- 08
- 02
- 16 - 25 - 26 - 36



EL 05.2

Porta asciugamani doppia asta
Towel rail with 2 bars
Porte serviette avec 2 barres
Handtuchhalter schwenkbar 2 Stangen

Полотенцедержатель двойной
cm 61 L x 14 P x 7 H - INT. 51

- 08
- 02
- 16 - 25 - 26 - 36

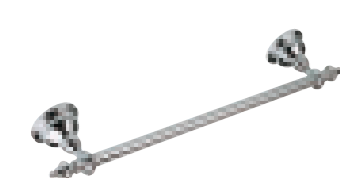

EL 45

Asta porta asciugamani
Towel rail
Porte serviette
Handtuchhalter

Полотенцедержатель +
cm 50 L x 9 P x 6 H - INT. 40

- 08
- 02
- 16 - 25 - 26 - 36

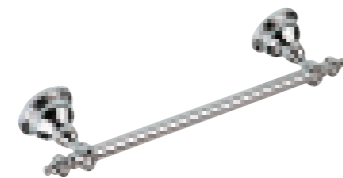

EL 06

Asta porta salviette
Towel rail
Porte serviettes
Handtuchhalter

Полотенцедержатель
cm 42 L x 9 P x 6 H - INT. 31,5

- 08
- 02
- 16 - 25 - 26 - 36



EL 16

Porta asciugamani snodo 2 aste
Towel rail with 2 adjustable bar
Porte serviettes à 2 barres orientables
Handtuchhalter schwenkbar 2 Stangen

Полотенцедержатель двойной поворотный
cm 38 L x 9 P x 16 H

- 08
- 02
- 16 - 25 - 26 - 36



EL 69

Porta salviette con porta sapone
Towel rail with soap dish
Porte serviettes avec porte savon
Handtuchhalter mit Seifenschale

Полотенцедержатель +
стеклянная мыльница
cm 52 L x 12 P x 6 H - INT. 42

- 08
- 02
- 16 - 25 - 26 - 36



EL 69 D

Porta salviette con dosatore sapone
Towel rail with soap dispenser
Porte serviettes avec porte savon liquid
Handtuchhalter mit Seifenspender

Полотенцедержатель +
стеклянный дозатор
cm 50 L x 9 P x 6 H - INT. 40

- 08
- 02
- 16 - 25 - 26 - 36



EL 07

Anello porta salviette
Ring serviette holder
Porte serviettes à anneau avec porte savon
Handtuchring

Полотенцедержатель – полукольцо
cm 30 L x 9 P x 15 H

- 08
- 02
- 16 - 25 - 26 - 36



EL 79

Anello porta salviette con porta sapone
Ring serviette holder with soap holder
Porte serviettes à anneau avec porte savon
Handtuchring mit Seifenschale

Полотенцедержатель – полукольцо +
стеклянная мыльница
cm 30 L x 10 P x 12 H

- 08
- 02
- 16 - 25 - 26 - 36



EL 79 D

Anello porta salviette con dosatore sapone
Ring serviette holder with soap dispenser
Porte serviettes à anneau avec porte savon liquid
Handtuchring mit Seifenspender

Полотенцедержатель – полукольцо +
стеклянный дозатор
cm 30 L x 9 P x 22 H

- 08
- 02
- 16 - 25 - 26 - 36





EL 09
Porta sapone a parete
Wall mounted soap dish
Porte savon à mur
Seifenschale wandhängend
 Настенная стеклянная мыльница
 cm 20 L x 11 P x 6 H

- 08
- 02
- 16 - 25 - 26 - 36



EL 10
Porta bicchiere a parete
Wall mounted holder
Porte à mur
Zahnbürstenhalter wandhängend
 Настенный стеклянный стакан
 cm 8 L x 11 P x 12 H

- 08
- 02
- 16 - 25 - 26 - 36



EL 30
Dosatore sapone liquido a parete
Wall-mounted soap dispenser
Doseur de savon
Seifenspender
 Настенный стеклянный дозатор
 cm 18 L x 11 P x 18 H

- 08
- 02
- 16 - 25 - 26 - 36



EL 14
Porta sapone con porta bicchiere a parete
Wall mounted soap dish + Glass holder
Porte savon + Porte verre mural
Seifenschale + Zahnbürstenhalter wandhängend
 Настенные стеклянные стакан + мыльница
 cm 26 L x 11 P x 12 H

- 08
- 02
- 16 - 25 - 26 - 36



EL 039
Porta scopino da appoggio
Toilet-brush with base
Porte balaynet d'appui
Bürostengarnitur freistehend
 Напольный металлический ёрш
 cm 12,5 Ø x 40 H

- 08
- 02
- 16 - 25 - 26 - 36



EL 11.11 S
Porta rotolo con scorta
Paper holder with supply
Porte rouleau avec escorte
Papierrollenhalter mit Ersatzhalter
 Бумагодержатель двойной
 cm 24 L x 9 P x 13 H

- 08
- 02
- 16 - 25 - 26 - 36



EL 1016
Maniglia per box doccia
Handle for shower enclosure
Poignée pour cabinets de douche
Handgriff für Duschkabinen
 Ручка для душевого угла
 cm 2 L x 6 P x 26 H - INT. 14

- 08
- 02
- 16 - 25 - 26 - 36



840
Kit collante e biadesivo per un articolo
Kit with bi-adhesive and glue for one article
Kit avec collant et biadhésif pour one article
Klebekit ist ein beidseitiger Klebestreifen
 Возможность установки на клей. БИФДГШ



EL 09 AP
Porta sapone da appoggio
Soap dish with base
Porte savon d'appui
Seifenschale freistehend
 Настольная стеклянная мыльница
 cm 15 L x 14 P x 12 H

- 08
- 02
- 16 - 25 - 26 - 36



EL 10 AP
Porta bicchiere da appoggio
Glass holder with base
Porte verre d'appui
Zahnbürstenhalter freistehend
 Настольный стеклянный стакан
 cm 9 L x 14 P x 12 H

- 08
- 02
- 16 - 25 - 26 - 36



EL 30 AP
Dosatore sapone liquido da appoggio
Soap dispenser with base
Porte savon d'appui
Seifenspender freistehend
 Настольный стеклянный дозатор
 cm Ø 8 x 18 H

- 08
- 02
- 16 - 25 - 26 - 36



EL 15
Porta sapone + Porta bicchiere da appoggio
Soap dish + Glass holder with base
Porte savon + Porte verre d'appui
Seifenschale + Zahnbürstenhalter freistehend
 Настольные стеклянные стакан + мыльница
 cm Ø 12,5 x 18 H

- 08
- 02
- 16 - 25 - 26 - 36

FINITURA

★ FINITURA DISPONIBILE IN 20 GG.
 Finish available in 20 days
 Finition disponible en 20 jours
 Oberfläche lieferbar in 20 Tagen
 Отделка доступны в течение 20 дней



CROMO
 Chrome
 Chrome
 Chrom
 хром

08



NICHEL SATINATO
 Satin nickel
 Nickel satiné
 Nickel satiniert
 Никель сатин

*36



CROMO - ORO
 Chrome - gold
 Chrome - or
 Chrom - Gold
 Хром - золото

02



ORO
 Gold
 Or
 Gold
 Золото

*16



BRONZO
 Bronze
 Bronze
 Bronze
 Бронза

25



RAME
 Copper
 Cuivre
 Kupfer
 Медь

*26



Su richiesta si realizzano aste porta asciugamani su misura, 10 gg
 Customized towel rails are available on request, 10 days
 Des porte-serviettes personnalisés sont disponibles sur demande, 10 jours
 Handtuchhalter sind auf Anfrage erhältlich, 10 Tagen
 По запросу мы можем производить полотенцедержатели под размер 10 дней



• 08 25 → 49 cm
 • 08 51 → 100 cm
 • 02 25 → 49 cm
 • 02 51 → 100 cm
 • 16 - 25 - 26 - 36 25 → 49 cm
 • 16 - 25 - 26 - 36 51 → 100 cm

Complementi / complements / compléments / ergänzungen / Дополнительно



EL 13
Porta accappatoio (2 ganci)
Robie hook (2 hooks)
Porte peignoir (2 peignoir)
Bademantelhaken (2 Haken)
 Крючок двойной
 cm 8 L x 9 P x 6 H

- 08
- 02
- 16 - 25 - 26 - 36



EL 11
Porta rotolo
Paper holder
Porte rouleau
Papierrollenhalter
 Бумагодержатель
 cm 22 L x 9 P x 6 H

- 08
- 02
- 16 - 25 - 26 - 36



EL 11 C
Porta rotolo coperto
Covered paper holder
Porte rouleau avec couvercle
Papierrollenhalter mit Deckel
 Бумагодержатель с крышкой
 cm 22 L x 11 P x 11 H

- 08
- 02
- 16 - 25 - 26 - 36



EL 12
Porta scopino a parete
Wall mounted toilet brush
Porte balayette à mur
Bürostengarnitur wandhängend
 Настенный стеклянный ёрш
 cm 10 L x 14 P x 35 H

- 08
- 02
- 16 - 25 - 26 - 36



> pag. 388



> pag. 392



> pag. 302



La legge dell'equilibrio



GIUNONE

Designer: Stilhaus
Materiale: Ottone, Tubo Ø 15, basetta a muro Ø 50
Accessori: Ceramica bianca
Finitura: 08-02-03-04-16-25-26-36
Fuori misura: Sì

Designer: Stilhaus
Material: Brass tube Ø 15, fixing plate cover Ø 50
Accessories: White ceramic
Finishes: 08-02-03-04-16-25-26-36
Customized: Yes

Designer: Stilhaus
Matière: Laiton, tuyau Ø 15, boucle couvre-vis Ø 50
Accessoires: Blanc céramique
Finitions: 08-02-03-04-16-25-26-36
Personnalisé: Oui

Designer: Stilhaus
Material: Messing Rohr Ø 15, Befestigungsplatten Oberfläche 50
Zubehör: weiße Keramik
Ausführungen: 08-02-03-04-16-25-26-36
Kundenwunsch: Ja

Дизайн: Stilhaus
Материал: латунь Ø 15, Ø 50
Аксессуары: белая керамика
Отделка: 08-02-03-04-16-25-26-36
Негабаритный: да



G 07
G 09



G 15



G 05.2



G 16

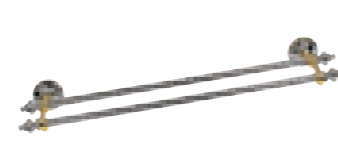
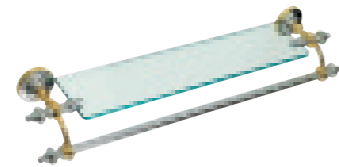
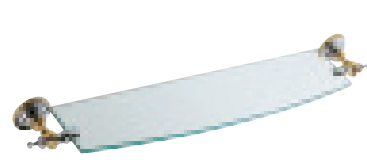

G 04

Mensola vetro 8mm
Shelf
Etagère
Ablage

Стеклопанельная полка – толщина стекла 8 mm
cm 70 L x 13 P x 6 H - INT. 51

- 08
- 02 - 03 - 04
- 16 - 25 - 26 - 36

G 33

Mensola e porta asciugamani
Shelf and towel rail
Etagère et porte serviette
Ablage mit Handtuchhalter

Стеклопанельная полка + полотенцедержатель
cm 60 L x 15 P x 9 H - INT. 51

- 08
- 02 - 03 - 04
- 16 - 25 - 26 - 36

G 05

Asta porta asciugamani
Towel rail
Porte serviette
Handtuchhalter

Полотенцедержатель
cm 60 L x 8 P x 6 H - INT. 51

- 08
- 02 - 03 - 04
- 16 - 25 - 26 - 36

G 05.2

Porta asciugamani doppia asta
Towel rail with 2 bars
Porte serviette avec 2 barres
Handtuchhalter schwenkbar 2 Stangen

Полотенцедержатель двойной
cm 60 L x 14 P x 9 H - INT. 51

- 08
- 02 - 03 - 04
- 16 - 25 - 26 - 36



G 06

Asta porta asciugamani
Towel rail
Porte serviette
Handtuchhalter

Полотенцедержатель
cm 40,5 L x 8 P x 6 H - INT. 31

- 08
- 02 - 03 - 04
- 16 - 25 - 26 - 36

G 16

Porta asciugamani snodo 2 aste
Towel rail with 2 adjustable bar
Porte serviettes à 2 barres orientables
Handtuchhalter schwenkbar 2 Stangen

Полотенцедержатель двойной поворотный
cm 38 L x 8 P x 16 H

- 08
- 02 - 03 - 04
- 16 - 25 - 26 - 36

G 69

Asta porta salviette con porta sapone
Towel rail with soap dish
Porte serviettes avec porte savon
Handtuchhalter mit Seifenschale

Полотенцедержатель + керамическая мыльница
cm 50 L x 13 P x 6 H - INT. 31

- 08
- 02 - 03 - 04
- 16 - 25 - 26 - 36

G 69 D

Asta porta salviette con dosatore sapone
Towel rail with soap dispenser
Porte serviettes avec porte savon liquid
Handtuchhalter mit Seifenspender

Полотенцедержатель + керамический дозатор
cm 50 L x 13 P x 6 H - INT. 31

- 08
- 02 - 03 - 04
- 16 - 25 - 26 - 36



G 79

Porta salviette con porta sapone
Wall mounted holder serviette + soap dish
Porte serviette + Porte savon mural
Handtuchhalter + Seifenschale

Полотенцедержатель – полукольцо + керамическая мыльница
cm 31 L x 13 P x 13 H

- 08
- 02 - 03 - 04
- 16 - 25 - 26 - 36

G 07

Anello porta salviette
Ring serviette holder
Porte serviettes à anneau
Handtuchring

Полотенцедержатель – полукольцо
cm 31 L x 8 P x 13 H

- 08
- 02 - 03 - 04
- 16 - 25 - 26 - 36

G 09

Porta sapone a parete
Wall mounted soap dish
Porte savon à mur
Seifenschale wandhängend

Настенная керамическая мыльница
cm 24 L x 13 P x 6 H

- 08
- 02 - 03 - 04
- 16 - 25 - 26 - 36

G 10

Porta bicchiere a parete
Wall mounted glass holder
Porte verre à mur
Zahnbürstenhalter wandhängend

Настенный керамический стакан
cm 18 L x 13 P x 12 H

- 08
- 02 - 03 - 04
- 16 - 25 - 26 - 36





G 30

Dosatore sapone liquido
Wall mounted soap dispenser
Porte savon liquid à mur
Seifenspender wandhängend
Настенный керамический
стакан 24 L x 13 P x 6 H

- 08
- 02 - 03 - 04
- 16 - 25 - 26 - 36



G 14

Porta sapone con porta bicchiere a parete
Wall mounted soap dish + Glass holder
Porte savon + Porte verre à mur
Seifenschale + Zahnbürstenhalter wandhängend
Настенные керамические стакан + мыльница
cm 30 L x 13 P x 12 H

- 08
- 02 - 03 - 04
- 16 - 25 - 26 - 36



G 719

Porta sapone da appoggio
Soap dish with base
Porte savon d'appui
Seifenschale freistehend
Настольная керамическая мыльница
cm 13 L x 10 P x 11 H - base cm Ø 10

- 08
- 02 - 03 - 04
- 16 - 25 - 26 - 36



G 718

Porta bicchiere da appoggio
Glass holder with base
Porte verre d'appui
Zahnbürstenhalter freistehend
Настольный керамический стакан
cm 10 L x 15 P x 15 H - base cm Ø 10

- 08
- 02 - 03 - 04
- 16 - 25 - 26 - 36



G 15 M

Porta sapone con porta bicchiere da appoggio
Soap dish + Glass holder
Porte savon + Porte verre
Seifenschale + Zahnbürstenhalter freistehend
Настольные керамические стакан +
мыльница
cm 30 L x 12,5 P x 16 H

- 08
- 02 - 03 - 04
- 16 - 25 - 26 - 36



G 13

Porta accappatoio (2 ganci)
Robe hook (2 hooks)
Porte peignoir (2 peignoir)
Bademantelhaken (2 Haken)
Крючок двойной
cm 12 L x 8 P x 6 H

- 08
- 02 - 03 - 04
- 16 - 25 - 26 - 36



G 13.1

Porta accappatoio singolo
Single robe hook
Porte peignoir
Bademantelhaken
Крючок одинарный
cm 5 L x 8 P x 6 H

- 08
- 02 - 03 - 04
- 16 - 25 - 26 - 36



G 11

Porta rotolo
Paper holder
Porte rouleau
Papierrollenhalter
Бумагодержатель
cm 25 L x 8 P x 6 H

- 08
- 02 - 03 - 04
- 16 - 25 - 26 - 36



G 11 C

Porta rotolo coperto
Covered paper holder
Porte rouleau avec couvercle
Papierrollenhalter mit Deckel
Бумагодержатель закрытый
cm 25 L x 11,5 P x 11 H

- 08
- 02 - 03 - 04
- 16 - 25 - 26 - 36



G 12

Porta scopino a parete
Wall mounted toilet brush
Porte balaynet à mur
Bürstengarnitur wandhängend
Настенный керамический ёрш
cm 10 L x 12 P x 34 H

- 08
- 02 - 03 - 04
- 16 - 25 - 26 - 36



G 12 A

Porta scopino d'appoggio in ceramica
Ceramic toilet brush
Porte balaynet en ceramique
Bürstengarnitur freistehend aus Keramik
Настольный керамический ёрш
cm Ø 13 x 40 H

- 08
- 02 - 03 - 04
- 16 - 25 - 26 - 36



G 039

Porta scopino da appoggio
Toilet brush with base
Porte balaynet d'appui
Bürstengarnitur freistehend
Настольный металлический ёрш
cm 12 Ø x 38 H

- 08
- 02 - 03 - 04
- 16 - 25 - 26 - 36

FINITURA



CROMO
Chrome
Chrome
Chrom
хром

08



BIANCO - CROMO
White - Chrome
Blanche - Chrome
Weiß - Chrom
Белый - хром

*03



ORO
Gold
Or
Gold
Золото

*16



RAME
Copper
Cuivre
Kupfer
Медь

26



CROMO - ORO
Chrome - gold
Chrome - or
Chrom - Gold
Хром - золото

02



BIANCO - ORO
White - Gold
Blanche - Or
Weiß - Gold
Белый - золото

*04



BRONZO
Bronze
Bronze
Bronze
Бронза

25



NICHEL SATINATO
Satin nickel
Nickel satiné
Nickel matt
Никель сатин

*36

Su richiesta si realizzano aste porta asciugamani su misura, 10 gg
Customized towel rails are available on request, 10 days
Des porte-serviettes personnalisés sont disponibles sur demande, 10 jours
Handtuchhalter sind auf Anfrage erhältlich, 10 tagen
По запросу мы можем производить полотенцедержатели под размер 10 дней



- 08 30 → 59 cm
- 08 61 → 100 cm
- 03 - 04 30 → 59 cm
- 03 - 04 61 → 100 cm
- 16 - 25 - 26 - 36 30 → 59 cm
- 16 - 25 - 26 - 36 61 → 100 cm

Complementi / complements / compléments / ergänzungen / Дополнительно



> pag. 268



> pag. 280



> pag. 296



> pag. 327



> pag. 388

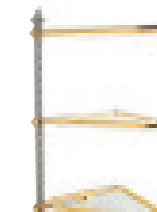

> pag. 386



> pag. 390

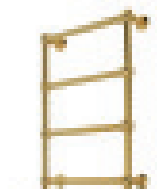

> pag. 305



Sinfonia d'autore

Designer: Stilhaus
Materiale: ottone, Tubo Ø12, basetta a muro Ø 60
Accessori: Ceramica
Finitura: 08-12-25-26
Fuori misura: Sì
Incollo: Sì

Designer: Stilhaus
Material: Brass tube Ø 12, fixing plate cover Ø60
Accessories: White ceramic
Finishes: 08-12-25-26
Customized: Yes
by glue : Yes

Designer: Stilhaus
Matière: Laiton, tuyau Ø 12, boucle couvre-vis Ø 60
Accessoires: Blanc céramique
Finitions: 08-12-25-26
Personnalisé: Oui
Par collage : Oui

Designer: Stilhaus
Material: Messing Rohr Ø12, befestigungsplatten oberfläche 60
Zubehör: Weiße Keramik
Ausführungen: 08-12-25-26
Kundenwunslh: Ja
Kleber: Ja

Дизайн: Stilhaus Материал: латунь Аксессуары: керамика
Отделка: 08-12-25-26
Негабаритный: да Установка на клей: да



IDRA



i 823
i 11

i 45



i 10



i 13



i 04

Mensola vetro 8mm
Shelf
Etagère
Ablage

Стеклоплатформа – толщина стекла 8mm
cm 70 L x 12 P x 10 H - INT. 64

- 08-12
- 25-26

i 05

Asta porta asciugamani
Towel rail
Porte serviette
Handtuchhalter

Полотенцедержатель
cm 63 L x 12 P x 10 H - INT. 52

- 08-12
- 25-26

i 45

Asta porta asciugamani
Towel rail
Porte serviette
Handtuchhalter

Полотенцедержатель
cm 45 L x 12 P x 10 H - INT. 44

- 08-12
- 25-26

i 06

Asta porta salviette
Towel rail
Porte serviette
Handtuchhalter

Полотенцедержатель
cm 34 L x 12 P x 10 H - INT. 22,50

- 08-12
- 25-26

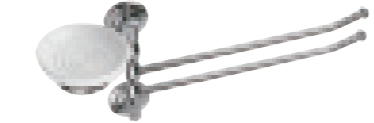

i 69

Asta porta salviette con porta sapone
Serviette holder with soap dish
Porte serviettes avec porte savon
Handtuchhalter mit Seifenschale

Полотенцедержатель + керамическая
мыльница
cm 58 L x 14 P x 10 H - INT. 22,50

- 08-12
- 25-26

i 16

Porta asciugamani snodo 2 aste
Towel rail with 2 adjustable bar
Porte serviettes à 2 barres orientables
Handtuchhalter schwenkbar 2 Stangen

Полотенцедержатель двойной поворотный
cm 38 L x 6 P x 18 H

- 08-12
- 25-26

i 18

Porta asciugamani snodo 2 aste con portasapone
Towel rail with 2 adjustable bar soap dish
Porte serviettes à 2 barres orientables avec porte savon
Handtuchhalter schwenkbar 2 Stangen und Seifenschale

Полотенцедержатель двойной поворотный
+ керамическая мыльница
cm 38 L x 12 P x 22 H

- 08-12
- 25-26

i 07

Anello porta salviette
Ring serviette holder
Porte serviettes à anneau
Handtuchring

Полотенцедержатель – кольцо
cm 23 L x 10 P x 28 H

- 08-12
- 25-26



i 09

Porta sapone a parete
Wall mounted soap dish
Porte savon à mur
Seifenschale wandhängend

Настенная керамическая мыльница
cm 21 L x 14 P x 10 H

- 08-12
- 25-26

i 10

Porta bicchiere a parete
Wall mounted glass holder
Porte verre à mur
Zahnbürstenhalter wandhängend

Настенный керамический стакан
cm 18 L x 13 P x 13 H

- 08-12
- 25-26

i 14

Porta sapone con porta bicchiere a parete
Wall mounted soap dish + Glass holder
Porte savon + Porte verre à mur
Seifenschale + Zahnbürstenhalter wandhängend

Настенные керамические стакан +
мыльница
cm 30 L x 14 P x 13 H

- 08-12
- 25-26

i 15

Porta sapone con porta bicchiere da appoggio
Soap dish + Glass holder
Porte savon + Porte verre
Seifenschale + Zahnbürstenhalter freistehend

Настольные керамические мыльница +
стакан
cm 30 L x Ø 12,5 x 16 H

- 08-12
- 25-26





i 13
Porta accappatoio (2 ganci)
Robie hook (2 hooks)
Porte peignoir (2 peignoir)
Bademantelhaken (2 Haken)
 Крючок двойной
 cm 13 L x 12 P x 10 H

- 08-12
- 25-26

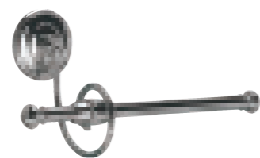

i 11
Porta rotolo
Paper holder
Porte rouleau
Papierrollenhalter
 Бумагодержатель
 cm 22 L x 12 P x 10 H

- 08-12
- 25-26



i 12 A
Porta scopino d'appoggio in ceramica
Ceramic toilet brush
Porte balayent en ceramique
Bürstengarnitur freistehend aus Keramik
 Напольный керамический ёрш
 cm 13 Ø x 40 H

- 08-12
- 25-26



i 039
Porta scopino da appoggio
Toilet brush with base
Porte balayent d'appui
Bürstengarnitur freistehend
 Напольный металлический ёрш
 cm 12,5 Ø x 40 H

- 08-12
- 25-26



i 823
Porta scopino d'appoggio in ceramica
Ceramic toilet brush
Porte balayent en ceramique
Bürstengarnitur freistehend aus Keramik
 Напольный керамический ёрш
 cm 14 Ø x 40 H

- 08-12
- 25



840
Kit collante e biadesivo per un articolo
Kit with bi-adhesive and glue for one article
Kit avec collant et biadhésif pour un article
Klebekit ist ein beidseitiger Klebestreifen
 Клей

-



i 09



Su richiesta si realizzano aste porta asciugamani su misura, 10 gg
Customized towel rails are available on request, 10 days
Des porte-serviettes personnalisés sont disponibles sur demande, 10 jours
Handtuchhalter sind auf Anfrage erhältlich, 10 Tagen
 По запросу мы можем производить полотенцедержатели под размер 10 дней



- 08-12 28 → 44 cm
- 08-12 46 → 90 cm
- 25-26 28 → 44 cm
- 25-26 46 → 90 cm

FINITURA



CROMO
Chrome
Chrome
Chrom
 хром

08



BRONZO
Bronze
Bronze
Bronze
 Бронза

25



RAME
Copper
Cuivre
Kupfer
 Медь

***26**



NIKEL LUCIDO
Polish nickel
Nikel poli
Nikel poliert
 Глянцевый никель

***12**

***FINITURA DISPONIBILE IN 20 GG.**
Finish available in 20 days
Finition disponible en 20 jours
Oberfläche lieferbar in 20 Tagen
 Отделка доступны в течение 20 дней

Complementi / complements / compléments / ergänzungen / Дополнительно



> pag. 270



> pag. 297



> pag. 279

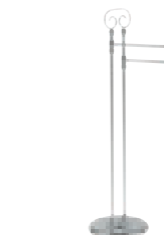

> pag. 322



> pag. 322



> pag. 322



> pag. 392

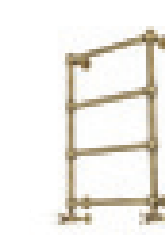

> pag. 303



Effervescenza italiana



MARTE

Designer: Stilhaus
Materiale: Ottone, Tubo Ø 16, basetta
a muro Ø 70
Accessori: Vetro Trasparente
Finitura: 08-16-25
Fuori misura: Sì
Incollo: Sì

Designer: Stilhaus
Material: Brass tube Ø 16, fixing plate
cover Ø 70
Accessories: Transparent glass
Finishes: 08-16-25
Customized: Yes
By glue: Yes

Designer: Stilhaus
Matière: Laiton, tuyau Ø 16, boucle
couvre-vis Ø 70
Accessoires: Verre transparent
Finitions: 08-16-25
Personnalisé: Oui
Incollo: Oui

Designer: Stilhaus
Material: Messing Rohr Ø 16, Befestigung-
platten Oberfläche Ø 70
Zubehör: Klarglas
Ausführungen: 08-16-25
Kundenwunsch: Ja
Kleber: Ja

Дизайн: Stilhaus Материал:
латунь ø 16, ø 70 Аксессуары:
прозрачное стекло Отделка:
08-16-25 Негабаритный:
да Установка на клей: да

MA 45



MA 11



MA 07

MA 09
MA 10
MA 30

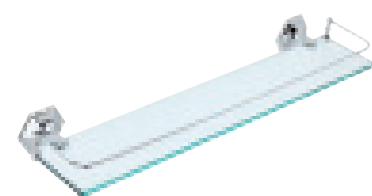

MA 04

Mensola vetro 8mm
Shelf
Étagère
Ablage

Стеклодержатель – толщина стекла 8mm
cm 60 L x 13 P x 7 H

- 08
- 16 - 25



MA 05

Asta porta asciugamani
Towel rail
Porte serviette
Handtuchhalter

Полотенцедержатель
cm 60 L x 9 P x 7 H - INT. 51,5

- 08
- 16 - 25

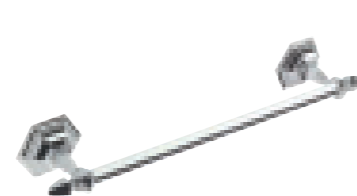

MA 45

Asta porta asciugamani
Towel rail
Porte serviette
Handtuchhalter

Полотенцедержатель
cm 49 L x 9 P x 7 H - INT. 40,5

- 08
- 16 - 25



MA 06

Asta porta salviette
Ring towel serviette
Porte serviettes anneau
Handtuchring

Полотенцедержатель
cm 39 L x 9 P x 7 H - INT. 30,5

- 08
- 16 - 25



MA 13

Porta accappatoio (2 ganci)
Robie hook (2 hooks)
Porte peignoir (2 peignoir)
Bademantelhaken (2 Haken)

Крючок двойной
cm 9 L x 8,5 P x 7 H

- 08
- 16 - 25



MA 11

Porta rotolo
Paper holder
Porte rouleau
Papierrollenhalter

Бумагодержатель
cm 20,5 L x 9 P x 12 H

- 08
- 16 - 25



MA 11 C

Porta rotolo con coperchio
Covered paper holder
Porte rouleau avec couvercle
Papierrollenhalter mit Deckel

Бумагодержатель с крышкой
cm 20,5 L x 14 P x 9 H

- 08
- 16 - 25



MA 039

Porta scopino
Toilet-brush
Porte balayent
Bürstengarnitur

Напольный металлический ёрш
cm 12,5 Ø x 41,5 H

- 08
- 16 - 25

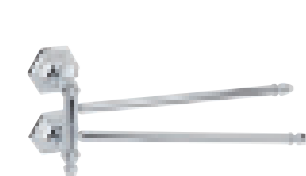

MA 16

Porta asciugamani snodo 2 aste
Towel rail with 2 adjustable bar
Porte serviettes à 2 barres orientables
Handtuchhalter schwenkbar 2 Stangen

Полотенцедержатель двойной поворотный
cm 4,5 L x 43 P x 19 H

- 08
- 16 - 25



MA 07

Anello porta salviette
Ring towel serviette
Porte serviettes anneau
Handtuchring

Полотенцедержатель – кольцо
cm 23,5 L x 8 P x 23,5 H

- 08
- 16 - 25



MA 09

Porta sapone a parete
Wall-mounted soap dish
Porte savon à mur
Seifenschale

Настенная стеклянная мыльница
cm 12,5 L x 15,5 P x 7 H

- 08
- 16 - 25



MA 10

Porta bicchiere a parete
Wall mounted glass holder
Porte verre à mur
Zahnbürstenhalter wandhängend

Настенный стеклянный стакан
cm 8 L x 13,5 P x 12 H

- 08
- 16 - 25

FINITURA



CROMO
Chrome
Chrome
Chrom
хром

08



ORO
Gold
Or
Gold
Золото

16

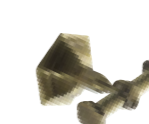

BRONZO
Bronze
Bronze
Bronze
Бронза

25



MA 30

Dosatore sapone liquido a parete
Wall mounted liquid soap dispenser
Doseur de savon liquid à mur
Seifenspender wandhängend

Настенный стеклянный дозатор
cm 7,5 L x 13,5 P x 19 H

- 08
- 16 - 25



MA 09 AP

Porta sapone da appoggio
Soap dish with base
Porte savon d'appui
Seifenschale freistehend

Настольная стеклянная мыльница
cm 12,5 Ø x 7 H

- 08
- 16 - 25



MA 10 AP

Porta bicchiere da appoggio
Glass holder with base
Porte verre d'appui
Zahnbürstenhalter freistehend

Настольный стеклянный стакан
cm 9 Ø x 14 H

- 08
- 16 - 25



MA 30 AP

Dosatore sapone liquido da appoggio
Soap dispenser with base
Porte savon d'appui
Seifenspender freistehend

Настольный стеклянный дозатор
cm 9 Ø x 19 H

- 08
- 16 - 25



Su richiesta si realizzano aste porta asciugamani su misura, 15 gg

Customized towel rails are available on request, 15 days

Des porte-serviettes personnalisés sont disponibles sur demande, 15 jours

Handtuchhalter sind auf Anfrage erhältlich, 15 tagen

По запросу мы можем производить полотенцедержатели под размер 15 дней



- 08 28 → 48 cm
- 08 50 → 100 cm
- 16 - 25 28 → 48 cm
- 16 - 25 50 → 100 cm

Complementi / complements / compléments / ergänzungen / Дополняет



> pag. 268



> pag. 294



> pag. 392

Espressione d'arte



 NEMI

Designer: Stilhaus
Materiale: Ottone, tubo Ø 20, basetta a muro Ø 60, legno, ceramica bianca o decorata
Accessori: ceramica
Finitura: 33-39-40
Fuori misura: Sì
Incollo: Sì

Designer: Stilhaus
Material: Brass tube Ø 16, fixing plate cove Ø 60, wood, white or decorated ceramic
Accessories: Ceramic
Finishes: 33-39-40
Customized: Yes
By glue: Yes

Designer: Stilhaus
Matière: laiton, tuyau Ø 16, boucle couvre-vis Ø 60, bois, blanc et noir céramique
Accessoires: Céramique
Finitions: 33-39-40
Personnalisé: Oui
Par collage: Oui

Designer: Stilhaus
Material: Messing Rohr Ø 16, Befestigungsplatten Oberfläche Ø 60, Holz, Keramik weiß oder dekoriert
Zubehör: Keramik
Ausführungen: 33-39-40
Kundenwunsch: Ja
Kleber: Ja

Дизайн: Stilhaus Материал: латунь, дерево, Ø 16, Ø 60 белая или декорированная керамика
Аксессуары: керамика Отделка: 33-39-40 Негабаритный: да
Установка на клей: да

N 07



N 06



N 11 - 186



N 15

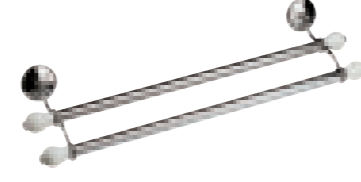
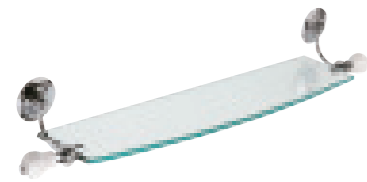

N 04

Mensola vetro 8 mm

Shelf
Etagère
Ablage

Стеклоянная полка – толщина стекла 8 mm
cm 70 L x 12 P x 10 H - INT. 62

• 33 - 39
• 40

N 05

Asta porta asciugamani

Towel rail
Porte serviette
Handtuchhalter

Полотенцедержатель
cm 60 L x 9 P x 10 H - INT. 51

• 33 - 39
• 40

N 05.2

Porta asciugamani doppia asta

Towel rail with 2 bars
Porte serviette avec 2 barres
Doppel Handtuchstange

Полотенцедержатель двойной
cm 60 L x 12 P x 16 H - INT. 51

• 33 - 39
• 40

N 06

Asta porta salviette

Serviette holder
Porte serviette
Handtuchhalter

Полотенцедержатель
cm 43 L x 9 P x 10 H - INT. 30

• 33 - 39
• 40



N 16

Porta asciugamani snodo 2 aste

Towel rail with 2 adjustable bar
Porte serviettes à 2 barres orientables
Handtuchhalter schwenkbar 2 Stangen

Полотенцедержатель двойной поворотный
cm 40 L x 4 P x 15 H

• 33 - 39
• 40

N 79

Porta salviette con porta sapone

Wall mounted holder serviette soap dish
Porte serviette + Porte savon à mur
Handtuchhalter + Seifenschale

Полотенцедержатель – полукольцо +
мыльница
cm 35 L x 13 P x 18 H

• 33 - 39
• 40

N 07

Anello porta salviette

Ring serviette holder
Porte serviettes à anneau
Handtuchring

Полотенцедержатель – полукольцо
cm 35 L x 9 P x 18 H

• 33 - 39
• 40

N 09

Porta sapone a parete

Wall mounted soap dish
Porte savon à mur
Seifenschale wandhängend

Настенная керамическая мыльница
cm 21 L x 13 P x 10 H

• 33 - 39
• 40



N 10

Porta bicchiere a parete

Wall mounted glass holder
Porte verre mural
Zahnbürstenhalter wandhängend

Настенный керамический стакан
cm 18 L x 10 P x 18 H

• 33 - 39
• 40

N 14

Porta sapone con porta bicchiere a parete

Wall mounted soap dish + Glass holder
Porte savon + Porte verre mural
Seifenschale + Zahnbürstenhalter wandhängend

Настенные керамические мыльница +
стакан
cm 32 L x 13 P x 18 H

• 33 - 39
• 40

743

Porta sapone da appoggio

Soap dish with base
Porte savon d'appui
Seifenschale

Настольная керамическая мыльница
cm Ø 12 x 5 H

• 01
• 40

744

Bicchiere in ceramica d'appoggio

Glass with base
Verre d'appui
Zahnputzbecher

Настольный керамический стакан
cm Ø 9 x 11 H

• 01
• 40



N 09





558

Dosatore sapone liquido d'appoggio
Soap dispenser with base
Doseur de savon liquid d'appui
Seifenspender
 Настольный керамический дозатор
 cm Ø 8 x 18 H

- 01
- 40



745

Contenitore in ceramica d'appoggio
Container with base
Containeur d'appui
Keramik Dose
 Настольный керамический контейнер
 cm Ø 9 x 13 H

- 01
- 40



N 15 M

Porta sapone con porta bicchiere da appoggio
Soap dish + Glass holder
Porte savon + Porte verre
Seifenschale + Zahnbürstenhalter freistehend
 Настольные керамические мыльница + стакан
 cm 30 L x Ø 12,5 x 18 H

- 33 - 39
- 40



N 13

Porta accappatoio (2 ganci)
Robie hook (2 hooks)
Porte peignoir (2 peignoir)
Bademantelhaken (2 Haken)
 Крючок двойной
 cm 10 L x 9 P x 10 H

- 33 - 39
- 40

FINITURA



CROMO - CER. BIANCO
Chrome - Cer. white
Chrome - Cér. blanc
Chrom - Ker. weiß
 хром - белая керамика

39



CROMO - CER. DECORATA
Chrome - Cer. white, decorated
Chrome - Cér. blanc, décoré
Chrom - Ker. weiß, bemalt
 хром - керамика декорированная

40



CROMO - NOCE SCURO
Chrome - Dark walnut
Chrome - Noix sombre
Chrom - Nußbraun dunkel
 хром - дерево орех

33



N 11 C

Porta rotolo coperto
Covered paper holder
Porte rouleau avec couvercle
Papierrollenhalter mit Deckel
 Полотенцедержатель с крышкой
 cm 20 L x 11 P x 12 H

- 33 - 39
- 40



N 11

Porta rotolo
Paper holder
Porte rouleau
Papierrollenhalter
 Бумагодержатель
 cm 21 L x 9 P x 10 H

- 33 - 39
- 40



N 039

Porta scopino da appoggio
Toilet brush with base
Porte balayent d'appui
Bürstengarnitur freistehend
 Напольный металлический ёрш
 cm 12,5 Ø x 42 H

- 33 - 39
- 40



186 GABRI

Porta scopino d'appoggio in ceramica
Ceramic toilet brush
Porte balayent en ceramique
Bürstengarnitur freistehend aus Keramik
 Напольный керамический ёрш
 cm 13 Ø x 43 H

- 33 - 39
- 40



Su richiesta si realizzano aste porta asciugamani su misura, 15 gg

Customized towel rails are available on request, 15 days
Des porte-serviettes personnalisés sont disponibles sur demande, 15 jours
Handtuchhalter sind auf Anfrage erhältlich, 15 tagen

По запросу мы можем производить полотенцедержатели под размер 15 дней



- 33 - 39 30 → 42 cm
- 33 - 39 44 → 100 cm
- 40 30 → 42 cm
- 40 44 → 100 cm



840

Kit collante e biadesivo per un articolo
Kit with bi-adhesive and glue for one article
Kit avec collant et biadhésif pour un article
Klebekit ist ein beidseitiger Klebestreifen
 Клей

Complementi / complements / compléments / ergänzungen / Дополнительно



> pag. 259



> pag. 280



> pag. 323



> pag. 323



> pag. 392



> pag. 350



> pag. 302



Potenza regale



NOTO

Designer: Stilhaus
Materiale: ottone, Tubo Ø 20, basetta a muro Ø 90
Accessori: Vetro trasparente
Finitura: 08-16
Fuori misura: Sì

Designer: Stilhaus
Material: Brass tube Ø 20, fixing plate cover Ø 90
Accessories: Transparent glass
Finishes: 08-16
Customized: Yes

Designer: Stilhaus
Matière: Laiton, tuyau Ø 20, boucle couvre-vis Ø 90
Accessoires: Verre transparent
Finitions: 08-16
Personnalisé: Oui

Designer: Stilhaus
Material: Messing Rohr Ø 20, Befestigungsplatten Oberfläche Ø 90
Zubehör: Klarglas
Ausführungen: 08-16
Kundenwunsch: Ja

Разработка дизайна: Stilhaus
Используемый материал: латунь Ø 20, Ø 90
Аксессуары: прозрачное стекло
Отделка: 08-16
Негабаритный: да



NT 11 C
NT 039

NT 45



NT 30



NT 13

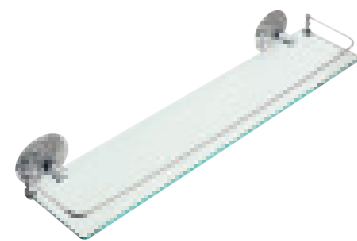

NT 04

Mensola vetro 8mm
Shelf
Étagère
Ablage

Стеклоянная полка – толщина стекла 8mm
cm 60 L x 13 P x 6 H

- 08
- 16



NT 05

Asta porta asciugamani
Towel rail
Porte serviette
Handtuchhalter

Полотенцедержатель
cm 61 L x 11 P x 9 H - INT. 51

- 08
- 16

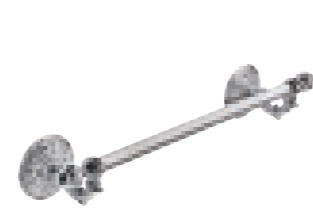

NT 45

Asta porta asciugamani
Towel rail
Porte serviette
Handtuchhalter

Полотенцедержатель
cm 51 L x 11 P x 9 H - INT. 41

- 08
- 16

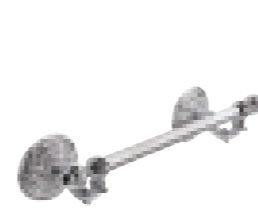

NT 06

Asta porta salviette
Towel rail
Porte serviette
Handtuchhalter

Полотенцедержатель
cm 41 L x 11 P x 9 H - INT. 30

- 08
- 16



NT 11

Porta rotolo
Paper holder
Porte rouleau
Papierrollenhalter

Бумагодержатель
cm 21 L x 11 P x 9 H

- 08
- 16



NT 11 C

Porta rotolo con coperchio
Covered paper holder
Porte rouleau avec couvercle
Papierrollenhalter mit Deckel

Бумагодержатель с крышкой
cm 21 L x 13 P x 13 H

- 08
- 16



NT 039

Porta scopino
Toilet brush with base
Porte balayent d'appui
Bürstengarnitur freistehend

Напольный металлический ёрш
cm 10 Ø x 50 H

- 08
- 16



NT 039 M

Porta scopino a parete
Wall mounted toilet brush
Porte balayent à mur
Bürstengarnitur wandhängend

Настенный керамический ёрш
cm 10 L x 12 P x 34 H

- 08
- 16



NT 16

Porta asciugamani snodo 2 aste
Towel rail with 2 adjustable bar
Porte serviettes à 2 barres orientables
Handtuchhalter schwenkbar 2 Stangen

Полотенцедержатель двойной поворотный
cm 38 L x 9 P x 19 H

- 08
- 16



NT 09

Porta sapone a parete
Wall mounted soap dish
Porte savon à mur
Seifenschale wandhängend

Настенная стеклянная мыльница
cm 12,5 L x 14 P x 9 H

- 08
- 16



NT 10

Porta bicchiere a parete
Wall mounted glass holder
Porte verre à mur
Zahnbürstenhalter wandhängend

Настенный стеклянный стакан
cm 9 L x 13 P x 9 H

- 08
- 16



NT 30

Dosatore sapone liquido a parete
Wall mounted soap dispenser
Porte savon liquid à mur
Seifenspender wandhängend

Настенный стеклянный дозатор
cm 9 L x 13 P x 24 H

- 08
- 16

FINITURA



CROMO
Chrome
Chrome
Chrom
Хром



ORO
Gold
Or
Gold
Золото

08

16



NT 09 AP

Porta sapone da appoggio
Soap dish with base
Porte savon d'appui
Seifenschale freistehend

Настольная стеклянная мыльница
cm 12,5 Ø x 7 H

- 08
- 16



NT 10 AP

Porta bicchiere da appoggio
Glass holder with base
Porte verre d'appui
Zahnbürstenhalter freistehend

Настольный стеклянный стакан
cm 9 Ø x 14 H

- 08
- 16



NT 30 AP

Dosatore sapone liquido da appoggio
Soap dispenser with base
Porte savon liquid d'appui
Seifenspender freistehend

Настольный стеклянный дозатор
cm 9 Ø x 19 H

- 08
- 16

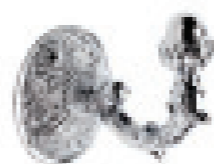

NT 13

Porta accappatoio
Robe hook
Porte peignoir
Bademantelhaken

Крючок
cm 9 L x 11 P x 11 H

- 08
- 16



Su richiesta si realizzano aste porta asciugamani su misura, 15 gg

Customized towel rails are available on request, 15gg
Des porte-serviettes personnalisés sont disponibles sur demande, 15gg
Handtuchhalter sind auf Anfrage erhältlich, 15gg

По запросу мы можем производить полотенецдержатели под размер 15gg



• 08	35 → 50 cm	€ 210,00
• 08	52 → 100 cm	€ 232,00
• 16	35 → 50 cm	€ 265,00
• 16	52 → 100 cm	€ 295,00

Complementi / complements / compléments / ergänzungen / Дополняет



> pag. 268



> pag. 243



> pag. 295



> pag. 239



> pag. 400



> pag. 303

Sorpresa di lusso



NOTO LIGHT

Designer: Stilhaus
Materiale: ottone, Tubo Ø 20, basetta
a muro Ø 90
Accessori: Vetro trasparente – Cristallo
di Murano
Finitura: 08-16
Fuori misura: Sì

Designer: Stilhaus
Material: Brass tube Ø 20, fixing plate
cover Ø 90
Accessories: Transparent glass - Murano's
crystal
Finishes: 08-16
Customized: Yes

Designer: Stilhaus
Matière: Laiton, tuyau Ø 20, boucle
couvre-vis Ø 90
Accessoires: Verre transparent - Cristal de
Murano
Finitions: 08-16
Personnalisé: Oui

Designer: Stilhaus
Material: Messing Rohr Ø 20, Befestigung-
splatten Oberfläche Ø 90
Zubehör: Klarglas - Murano-Kristall
Ausführungen: 08-16
Kundenwunsch: Ja
Разработка дизайна: Stilhaus

Используемый материал: латунь
Ø 20, Ø 90
Аксессуары: прозрачное стекло -
стекло мурано
Отделка: 08-16
Негабаритный: да

NT 45 V



NT 10 V



NT 11 CV



NT 06 V
NT 09 V

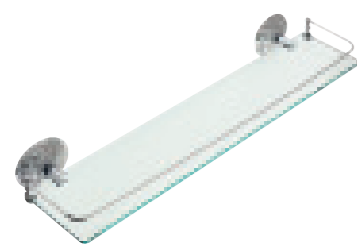

NT 04 V

Mensola vetro 8mm
Shelf
Étagère
Ablage
Стеклопалка – толщина стекла 8mm
cm 60 L x 13 P x 6 H

- 08
- 16



NT 05 V

Asta porta asciugamani
Towel rail
Porte serviette
Handtuchhalter
Полотенцедержатель
cm 65 L x 11 P x 9 H x INT. 51

- 08
- 16



NT 45 V

Asta porta asciugamani
Towel rail
Porte serviette
Handtuchhalter
Полотенцедержатель
cm 55 L x 11 P x 9 H x INT. 41

- 08
- 16



NT 06 V

Asta porta salviette
Towel rail
Porte serviette
Handtuchhalter
Полотенцедержатель
cm 45 L x 11 P x 9 H x INT. 30

- 08
- 16



NT 11 V

Porta rotolo
Paper holder
Porte rouleau
Papierrollenhalter
Бумагодержатель
cm 23,5 L x 11 P x 9 H

- 08
- 16

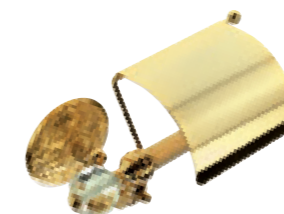

NT 11 CV

Porta rotolo con coperchio
Covered paper holder
Porte rouleau avec couvercle
Papierrollenhalter mit Deckel
Бумагодержатель с крышкой
cm 23,5 L x 13 P x 9 H

- 08
- 16



NT 039 V

Porta scopino da appoggio
Toilet brush with base
Porte balayent d'appui
Bürstengarnitur freistehend
Напольный металлический ёрш
cm 10 Ø x 53 H

- 08
- 16



NT 039 M

Porta scopino a parete
Wall mounted toilet brush
Porte balayent à mur
Bürstengarnitur wandhängend
Настенный металлический ёрш
cm 10 L x 12 P x 34 H

- 08
- 16

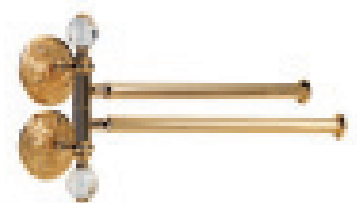

NT 16 V

Porta asciugamani snodo 2 aste
Towel rail with 2 adjustable bar
Porte serviettes à 2 barres orientables
Handtuchhalter schwenkbar 2 Stangen
Полотенцедержатель двойной поворотный
cm 41 L x 8 P x 24 H

- 08
- 16



NT 09 V

Porta sapone a parete
Wall mounted soap dish
Porte savon à mur
Seifenscale wandhängend
Настенная стеклянная мыльница
cm 15 L x 16 P x 13 H

- 08
- 16



NT 10 V

Porta bicchiere a parete
Wall mounted glass holder
Porte verre à mur
Zahnbürstenhalter wandhängend
Настенный стеклянный стакан
cm 12 L x 12 P x 18 H

- 08
- 16



NT 30 V

Dosatore sapone liquido a parete
Wall mounted soap dispenser
Porte savon liquid à mur
Seifenspender wandhängend
Настенный стеклянный дозатор
cm 12 L x 12 P x 25 H

- 08
- 16

FINITURA



CROMO
Chrome
Chrome
Chrom
Хром

08



ORO
Gold
Or
Gold
Золото

16



Su richiesta si realizzano aste porta asciugamani su misura, 15 gg

Customized towel rails are available on request, 15gg
Des porte-serviettes personnalisés sont disponibles sur demande, 15gg
Handtuchhalter sind auf Anfrage erhältlich, 15gg

По запросу мы можем производить полотенцедержатели под размер 15gg



- 08 35 → 54 cm
- 08 56 → 100 cm
- 16 35 → 54 cm
- 16 56 → 100 cm



NT 09 AP

Porta sapone da appoggio
Soap dish with base
Porte savon d'appui
Seifenschale freistehend
Настольная стеклянная мыльница
cm 12,5 Ø x 7 H

- 08
- 16



NT 10 AP

Porta bicchiere da appoggio
Glass holder with base
Porte verre d'appui
Zahnbürstenhalter freistehend
Настольный стеклянный стакан
cm 9 Ø x 14 H

- 08
- 16



NT 30 AP

Dosatore sapone liquido da appoggio
Soap dispenser with base
Porte savon liquid d'appui
Seifenspender freistehend
Настольный стеклянный дозатор
cm 9 Ø x 19 H

- 08
- 16

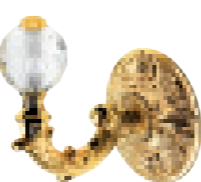

NT 13 V

Porta accappatoio
Robe hook
Porte peignoir
Bademantelhaken
Крючок
cm 9 L x 11 P x 13,5 H

- 08
- 16

Complementi / complements / compléments / ergänzungen / Дополняет



> pag. 268



> pag. 243



> pag. 295



> pag. 239



> pag. 400



> pag. 303

Atto terzo. Scena prima



 OPERA

Designer: Massimiliano Settimelli
Materiale: ottone, Tubo Ø 12, basetta
a muro Ø 50
Accessori: Ceramica bianca
Finitura: 08-16
Fuori misura: Sì

Designer: Massimiliano Settimelli
Material: Brass tube Ø 12, fixing plate
cover Ø 50
Accessories: White ceramic
Finishes: 08-16
Customized: Yes

Designer: Massimiliano Settimelli
Matière: Laiton, tuyau Ø 12, boucle
couvre-vis Ø 50
Accessoires: Blanc ceramic
Finitions: 08-16
Personnalisé: Oui

Designer: Massimiliano Settimelli
Material: Messing Rohr Ø 12, Befestigung-
splatten Oberfläche Ø 50
Zubehör: weiße Keramik
Ausführungen: 08-16
Kundenwunsch: Ja

Разработка дизайна: Stilhaus
Используемый материал: латунь
Ø 12, Ø 50
Аксессуары: белая керамика
Отделка: 08-16
Негабаритный: да

OP 45



OP 07



OP 06.1



OP 10
OP 30



OP 04

Mensola vetro 8mm
Shelf
Étagère
Ablage

Стеклоплатформа – толщина стекла 8mm
cm 60 L x 13 P x 6 H

- 08
- 16



OP 05

Asta porta asciugamani
Towel rail
Porte serviette
Handtuchhalter

Полотенцедержатель
cm 62 L x 9 P x 5 H x INT. 58

- 08
- 16



OP 45

Asta porta asciugamani
Towel rail
Porte serviette
Handtuchhalter

Полотенцедержатель
cm 45 L x 9 P x 5 H x INT. 58

- 08
- 16



OP 06

Asta porta salviette
Towel rail
Porte serviette
Handtuchhalter

Полотенцедержатель
cm 32 L x 9 P x 5 H x INT. 28

- 08
- 16



OP 13

Porta accappatoio
Robe hook
Porte peignoir
Bademantelhaken

Крючок
cm 5 L x 5 P x 11 H

- 08
- 16



OP 13.2

Porta accappatoio (2 ganci)
Robe hook (2 hooks)
Porte peignoir (2 peignoir)
Bademantelhaken (2 Haken)

Крючок двойной
cm 10 L x 9 P x 6 H

- 08
- 16



OP 11

Porta rotolo
Paper holder
Porte rouleau
Papierrollenhalter

Бумагодержатель
cm 20 L x 9 P x 9 H

- 08
- 16



OP 11 C

Porta rotolo con coperchio
Covered paper holder
Porte rouleau avec couvercle
Papierrollenhalter mit Deckel

Бумагодержатель с крышкой
cm 20 L x 10 P x 9 H

- 08
- 16



OP 06.1

Porta salviette
Towel rail
Porte serviette
Handtuchhalter

Полотенцедержатель
cm 5 L x 9 P x 5 H

- 08
- 16



OP 07

Anello porta salvietta
Ring serviette holder
Porte serviettes à anneau
Handtuchring

Полотенцедержатель – кольцо
cm 23 L x 9 P x 21 H

- 08
- 16



OP 09

Porta sapone a parete
Wall mounted soap dish
Porte savon à mur
Seifenschale wandhängend

Настенная стеклянная мыльница
cm 12 L x 15 P x 8 H

- 08
- 16



OP 10

Porta bicchiere a parete
Wall mounted glass holder
Porte verre à mur
Zahnbürstenhalter wandhängend

Настенный стеклянный стакан
cm 8 L x 10 P x 15 H

- 08
- 16



OP 12

Porta scopino d'appoggio in ceramica
Ceramic toilet brush
Porte balaynet en ceramique
Bürstengarnitur freistehend aus Keramik

Напольный керамический ёрш
cm 14 Ø x 44 H

- 08
- 16



OP 039 M

Porta scopino a parete
Wall mounted toilet brush
Porte balaynet à mur
Bürstengarnitur wandhängend

Настенный металлический ёрш
cm 8 L x 8,5 P x 41 H

- 08
- 16

FINITURA



CROMO
Chrome
Chrom
Хром

08



ORO
Gold
Or
Gold
Золото

16



OP 30

Dosatore sapone liquido a parete
Wall mounted soap dispenser
Porte savon liquid à mur
Seifenspender wandhängend

Настенный стеклянный дозатор
cm 8 L x 10 P x 23 H

- 08
- 16



OP 09 AP

Porta sapone da appoggio
Soap dish with base
Porte savon d'appui
Seifenschale freistehend

Настольная стеклянная мыльница
cm 12 Ø x 5 H

- 08
- 16



OP 10 AP

Porta bicchiere da appoggio
Glass holder with base
Porte verre d'appui
Zahnbürstenhalter freistehend

Настольный стеклянный стакан
cm 10 Ø x 12 H

- 08
- 16



OP 30 AP

Dosatore sapone liquido da appoggio
Soap dispenser with base
Porte savon liquid d'appui
Seifenspender freistehend

Настольный стеклянный дозатор
cm 10 Ø x 21 H

- 08
- 16

 Su richiesta si realizzano aste porta asciugamani su misura, 10 gg
Customized towel rails are available on request, 10 days
Des porte-serviettes personnalisés sont disponibles sur demande, 10 jours
Handtuchhalter sind auf Anfrage erhältlich, 10 Tagen
По запросу мы можем производить полотенецедержатели под размер 10 дней



- 08 25 → 45 cm
- 08 47 → 100 cm
- 16 25 → 45 cm
- 16 47 → 100 cm

Complementi / complements / compléments / ergänzungen / Дополняет



> pag. 269



> pag. 287



> pag. 392

Eleganza senza tempo



PRISMA

Designer: Stilhaus
Materiale: ottone, Tubo Ø16, basetta a muro 45x45
Accessori: Ceramica bianca o nera
Finitura: 08-16-25-36
Fuori misura: Sì

Designer: Stilhaus
Material: Brass tube Ø 16, fixing plate cover 45x45
Accessories: White or black ceramic
Finishes: 08-16-25-36
Customized: Yes

Designer: Stilhaus
Matière: Laiton, tuyau Ø 16, boucle couvre-vis 45x45
Accessoires: Blanc or noir céramique
Finitions: 08-16-25-36
Personnalisé: Oui

Designer: Stilhaus
Material: Messing Rohr Ø 16, Befestigungsplatten Oberfläche 45x45
Zubehör: Keramik schwarz oder weiß
Ausführungen: 08-16-25-36
Kundenwunsch: Ja

Разработка дизайна: Stilhaus
Используемый материал: латунь Ø 16, 45x45
Аксессуары: белая или черная керамика
Отделка: 08-16-25-36
Негабаритный: да

PR 18



PR 10 - PR 30



PR 45



PR 09
PR 06



PR 04

Mensola vetro 8mm
Shelf
Étagère
Ablage

Стеклоплатформа – толщина стекла 8mm
cm 75 L x 12 P x 4,5 H - INT. 66

- 08
- 16-25-36



PR 05

Asta porta asciugamani
Towel rail
Porte serviette
Handtuchhalter

Полотенцедержатель
cm 60 L x 9 P x 4,5 H - INT. 51

- 08
- 16-25-36



PR 05.2

Porta asciugamani doppia asta
Double towel rail
Porte serviettes avec 2 bars
Doppel Handtuchstange

Полотенцедержатель двойной
cm 60 L x 14 P x 7 H - INT. 51

- 08
- 16-25-36



PR 45

Asta porta asciugamani
Towel rail
Porte serviette
Handtuchhalter

Полотенцедержатель
cm 50 L x 9 P x 4,5 H - INT. 40

- 08
- 16-25-36

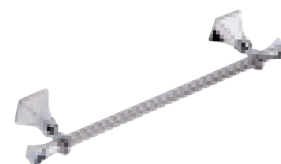

PR 06

Asta porta salviette
Towel rail
Porte serviettes
Handtuchhalter

Полотенцедержатель
cm 39 L x 9 P x 4,5 H - INT. 31,50

- 08
- 16-25-36



PR 16

Porta asciugamani snodo 2 aste
Towel rail with 2 adjustable bar
Porte serviettes à 2 barres orientables
Handtuchhalter schwenkbar 2 Stangen

Полотенцедержатель двойной поворотный
cm 4,5 L x 43 P x 19 H

- 08
- 16-25-36



PR 18

Porta asciugamani snodo con porta sapone
Towel rail adjustable with soap dish
Porte serviettes orientables avec porte savon
Handtuchhalter schwenkbar mit Seifenschale

Полотенцедержатель двойной поворотный
+ керамическая мыльница
cm 4,5 L x 43 P x 35 H

- 08
- 16-25-36



PR 18 D

Porta asciugamani snodo con dosatore
Towel rail adjustable with soap dispenser
Porte serviettes orientables avec porte savon liquid
Handtuchhalter schwenkbar mit Seifenspender

Полотенцедержатель двойной поворотный
+ керамический дозатор
cm 4,5 L x 43 P x 35 H

- 08
- 16-25-36



PR 07

Anello porta salviette
Ring serviette holder
Porte serviettes à anneau
Handtuchring

Полотенцедержатель – кольцо
cm 23 L x 9 P x 21 H

- 08
- 16-25-36



PR 09

Porta sapone a parete
Wall mounted soap dish
Porte savon à mur
Seifenschale wandhängend

Настенная керамическая мыльница
cm 11 L x 12,5 P x 10,5 H

- 08 bianco / white / blanc / weiß / Белый
- 16-25-36 bianco / white / blanc / weiß
- 08 nero / black / noir / schwarz / черно
- 16-25-36 nero / black / noir / schwarz



PR 10

Porta bicchiere a parete
Wall mounted glass holder
Porte verre à mur
Zahnbürstenhalter wandhängend

Настенный керамический стакан
cm 7,5 L x 10,5 P x 17,5 H

- 08 bianco / white / blanc / weiß / Белый
- 16-25-36 bianco / white / blanc / weiß
- 08 nero / black / noir / schwarz / черно
- 16-25-36 nero / black / noir / schwarz



PR 30

Dosatore sapone liquido a parete
Wall mounted soap dispenser
Porte savon liquid à mur
Seifenspender wandhängend

Настенный стеклянный дозатор
cm 7,5 L x 10,5 P x 26 H

- 08 bianco / white / blanc / weiß / Белый
- 16-25-36 bianco / white / blanc / weiß
- 08 nero / black / noir / schwarz / черно
- 16-25-36 nero / black / noir / schwarz





794

Porta sapone da appoggio
Soap dish with base
Porte savon d'appui
Seifenschale
 Настольная керамическая мыльница
 cm 10 L x 10 P x 10 H

- bianco / white / blanc / weiß / белый
- nero / black / noir / schwarz / черно



793

Bicchiera da appoggio
Glass with base
Verre d'appui
Zahnputzbecher
 Настольный керамический стакан
 cm 7,5 L x 7,5 P x 10 H

- bianco / white / blanc / weiß / белый
- nero / black / noir / schwarz / черно



795

Dosatore sapone liquido da appoggio
Liquid soap dispenser
Porte savon liquid
Seifenspender
 Настольный керамический дозатор
 cm 7,5 L x 7,5 P x 10 H

- 08 bianco / white / blanc / weiß / белый
- 16-25-36 bianco / white / blanc / weiß
- 08 nero / black / noir / schwarz / черно
- 16-25-36 nero / black / noir / schwarz



PR 13

Porta accappatoio (2 ganci)
Robie hook (2 hooks)
Porte peignoir (2 peignoir)
Bademantelhaken (2 Haken)
 Крючок двойной
 cm 8 L x 9 P x 4,5 H

- 08
- 16 - 25 - 36

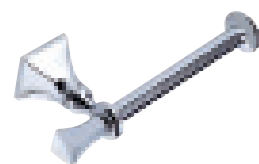

PR 11

Porta rotolo
Paper holder
Porte rouleau
Papierrollenhalter
 Бумагодержатель
 cm 22 L x 9 P x 4,5 H

- 08
- 16 - 25 - 36

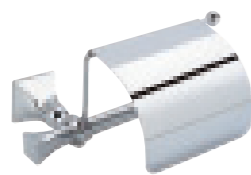

PR 11 C

Porta rotolo coperto
Covered paper holder
Porte rouleau avec couvercle
Papierrollenhalter mit Deckel
 Бумагодержатель закрытый
 cm 22 L x 11 P x 11 H

- 08
- 16 - 25 - 36



PR 039

Porta scopino da appoggio
Toilet-brush with base
Porte balayent d'appui
Bürstengarnitur freistehend
 Напольный металлический ёрш
 cm 8 L x 8,5 P x 41 H

- 08
- 16 - 25 - 36



PR 796

Porta scopino d'appoggio in ceramica
Ceramic toilet brush
Porte balayent en ceramique
Bürstengarnitur freistehend aus Keramik
 Напольный керамический ёрш
 cm 10 L x 10 P x 38 H

- 08 bianco / white / blanc / weiß / белый
- 16-25-36 bianco / white / blanc / weiß
- 08 nero / black / noir / schwarz / черно
- 16-25-36 nero / black / noir / schwarz



PR 039 M

Porta scopino a parete
Wall mounted toilet brush
Porte balayent à mur
Bürstengarnitur wandhängend
 Настенный металлический ёрш
 cm 8 L x 8,5 P x 41 H

- 08
- 16 - 25 - 36



PR 11.11 S

Porta rotolo con scorta
Paper holder with supply
Porte rouleau avec escorte
Papierrollenhalter mit Ersatzhalter
 Бумагодержатель двойной
 cm 24 L x 9 P x 13 H

- 08
- 16 - 25 - 36



PR 1016

Maniglia per box doccia
Handle for shower enclosure
Poignée pour cabinets de douche
Handgriff für Duschkabinen
 Ручка для душевого угла
 cm 2 L x 6 P x 26 H-INT. 14

- 08
- 16 - 25 - 36



PR 11 C

FINITURA



CROMO
 Chrome
 Chrome
 Chrom
 хром

08



ORO
 Gold
 Or
 Gold
 Золото

16



BRONZO
 Bronze
 Bronze
 Bronze
 Бронза

25

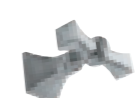

NICHEL SATINATO
 Satin nickel
 Nickel satiné
 Nickel satiné
 Никель сатин

36



Su richiesta si realizzano aste porta asciugamani su misura, 10 gg

Customized towel rails are available on request, 10 days
Des porte-serviettes personnalisés sont disponibles sur demande, 10 jours
Handtuchhalter sind auf Anfrage erhältlich, 10 Tagen

По запросу мы можем производить полотенцедержатели под размер 10 дней



- 08 30 → 49 cm
- 08 51 → 100 cm
- 16 - 25 - 36 30 → 49 cm
- 16 - 25 - 36 51 → 100 cm

Complementi / complements / compléments / ergänzungen / Дополняет



> pag. 271



> pag. 294



> pag. 319



> pag. 319



> pag. 319



> pag. 392

Funzione globale



SMART

Designer: Stilhaus
Materiale: Ottone, Tubo Ø16 , basetta
a muro Ø45
Accessori: Ceramica bianca
Finitura: 08-02-25
Fuori misura: Si

Designer: Stilhaus
Material: Brass tube Ø20, fixing plate
cover Ø 45
Accessories: White ceramic
Finishes: 08-02-25
Customized: Yes

Designer: Stilhaus
Matière: Laiton, tuyau Ø 16, boucle
couvre-vis Ø45
Accessoires: Blanc céramique
Finitions: 08-02-25
Personnalisé: Oui

Designer: Stilhaus
Material: Messing Rohr Ø16, Befestigung-
splatten Oberfläche Ø45
Zubehör: Weiße Keramik
Ausführungen: 08-02-25
Kundenwunsch: Ja

Разработка дизайна: Stilhaus
Используемый материал: латунь
Ø 16, Ø 45
Аксессуары: белая керамика
Отделка: 08-02-25
Негабаритный: да



SM 09

SM 45



SM 11



SM 10

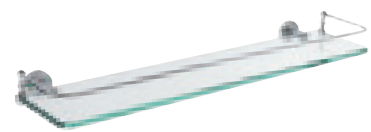

SM 04

Mensola vetro 8 mm
Shelf
Étagère
Ablage
Стеклоянная полка – толщина стекла 8mm
cm 60 L x 7 P x 5 H

- 08
- 02
- 25



SM 05

Asta porta asciugamani
Towel rail
Porte serviette
Handtuchhalter
Полотенцедержатель
cm 57 L x 7 P x 5 H - INT.49,5

- 08
- 02
- 25



SM 45

Asta porta asciugamani
Towel rail
Porte serviette
Handtuchhalter
Полотенцедержатель
cm 44 L x 7 P x 5 H - INT.37,5

- 08
- 02
- 25



SM 06.2

Asta porta salviette
Towel rail
Porte serviette
Handtuchhalter
Полотенцедержатель
cm 34 L x 7 P x 5 H - INT.28

- 08
- 02
- 25

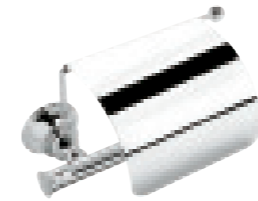

SM 11 C

Porta rotolo coperto
Covered paper holder
Porte rouleau avec couvercle
Papierrollenhalter mit Deckel
Бумагодержатель закрытый
cm 18 L x 10 P x 15 H

- 08
- 02
- 25



SM 039M

Porta scopino a parete
Wall-mounted toilet-brush
Porte balayent à mur
Bürstengarnitur wandhängend
Настенный металлический ёрш
cm Ø 8,5 x 36 H

- 08
- 02
- 25



SM 039

Porta scopino da appoggio
Toilet brush with base
Porte balayent d'appui
Bürstengarnitur freistehend
Напольный металлический ёрш
cm Ø 8,5 x 36 H

- 08
- 02
- 25



185

Porta asciugamani snodo 2 aste
Towel rail with 2 adjustable bar
Porte serviettes à 2 barres orientables
Handtuchhalter schwenkbar 2 Stangen
Полотенцедержатель двойной поворотный
cm 36 L x 4 P x 13 H

- 08
- 02
- 25



SM 07

Anello porta salviette
Ring serviette holder
Porte serviettes à anneau
Handtuchring
Полотенцедержатель – кольцо
cm 21 L x 7,5 P x 22 H

- 08
- 02
- 25



SM 09

Porta sapone a parete
Wall mounted soap dish
Porte savon à mur
Seifenschale wandhängend
Настенная керамическая мыльница
cm 15 L x 13 P x 6 H

- 08
- 02
- 25



SM 10

Porta bicchiere a parete
Wall mounted glass holder
Porte verre à mur
Zahnbürstenhalter wandhängend
Настенный керамический стакан
cm 9 L x 13 P x 10 H

- 08
- 02
- 25

FINITURA

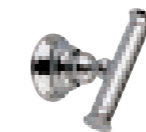

CROMO
Chrome
Chrome
Chrom
Хром

08



CROMO - ORO
Chrome - Gold
Chrome - Or
Chrom - Gold
Хром - золото

02



BRONZO
Bronze
Bronze
Bronze
Бронза

25

Su richiesta si realizzano aste porta asciugamani su misura, 10 gg
Customized towel rails are available on request, 10 days
Des porte-serviettes personnalisés sont disponibles sur demande, 10 jours
Handtuchhalter sind auf Anfrage erhältlich, 10 tagen
По запросу мы можем производить полотенцедержатели под размер 10 дней



- 08 28 → 43 cm
- 08 45 → 100 cm
- 02 28 → 43 cm
- 02 45 → 100 cm
- 25 28 → 43 cm
- 25 45 → 100 cm



SM 30

Dosatore sapone a parete
Wall mounted soap dispenser
Porte savon liquid à mur
Seifenspender wandhängend
Настенный дозатор
cm 9 L x 13 P x 18 H

- 08
- 02
- 25



SM 13

Porta accappatoio (2 ganci)
Robie hook (2 hooks)
Porte peignoir (2 peignoir)
Bademantelhaken (2 Haken)
Крючок двойной
cm 11 L x 7 P x 5 H

- 08
- 02
- 25



SM 13.1

Porta accappatoio singolo
Robe hook
Porte peignoir
Bademantelhaken
Крючок двойной
cm 5 L x 6,5 P x 5 H

- 08
- 02
- 25



SM 11

Porta rotolo
Paper holder
Porte rouleau
Papierrollenhalter
Бумагодержатель
cm 17 L x 7 P x 5 H

- 08
- 02
- 25

Complementi / complements / compléments / ergänzungen / Дополняет



> pag. 258



> pag. 294



> pag. 389



> pag. 392



> pag. 302

Luce superiore



SMART LIGHT

Designer: Stilhaus
Materiale: ottone, Tubo Ø16, basetta a muro Ø45
Accessori: Vetro trasparente
Finitura: 08-16-25
Fuori misura: Sì

Designer: Stilhaus
Material: Brass tube Ø20, fixing plate cover Ø45
Accessories: Transparent glass
Finishes: 08-16-25
Customized: Yes

Designer: Stilhaus
Matière: Laiton, tuyau Ø16, boucle couvre-vis Ø45
Accessoires: Verre transparent
Finitions: 08-16-25
Personnalisé: Oui

Designer: Stilhaus
Material: Messing Rohr Ø16, Befestigungsplatten Oberfläche Ø45
Zubehör: Klarglas
Ausführungen: 08-16-25
Kundenwünsche: Ja

Разработка дизайна: Stilhaus
Используемый материал: латунь Ø16, Ø45
Аксессуары: прозрачное стекло
Отделка: 08-16-25
Негабаритный: да

SL 45



SL 07



SL 11



SL 09
SL 30

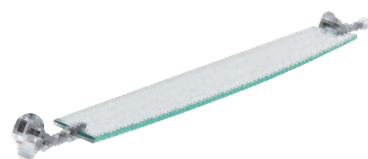

SL 04

Mensola vetro 8mm
Shelf
Étagère
Ablage

Стеклоянная полка – толщина стекла 8mm
cm 70 L x 13 P x 5 H - INT. 67

- 08
- 16 - 25



SL 05

Asta porta asciugamani
Towel rail
Porte serviettes
Handtuchhalter

Полотенцедержатель
cm 62 L x 7 P x 5 H - INT. 49,5

- 08
- 16 - 25



SL 45

Asta porta asciugamani
Towel rail
Porte serviettes
Handtuchhalter

Полотенцедержатель
cm 45 L x 7 P x 5 H - INT. 37,5

- 08
- 16 - 25



SL 06

Asta porta salviette
Towel rail
Porte serviettes
Handtuchhalter

Полотенцедержатель
cm 39 L x 7 P x 5 H - INT. 28

- 08
- 16 - 25



SL 11 C

Porta rotolo coperto
Covered paper holder
Porte rouleau avec couvercle
Papierrollenhalter mit Deckel

Бумагодержатель закрытый
cm 19 L x 7 P x 5 H

- 08
- 16 - 25



SL 039 M

Porta scopino a parete
Wall mounted toilet-brush
Porte balayent à mur
Bürstengarnitur wandhängend

Настенный металлический ёрш
cm 8,5 Ø x 38 H

- 08
- 16 - 25



SL 039

Porta scopino da appoggio
Toilet-brush with base
Porte balayent d'appui
Bürstengarnitur freistehend

Напольный металлический ёрш
cm 12,5 Ø x 38 H

- 08
- 16 - 25



SL 1016

Maniglia per box doccia
Handle for shower enclosure
Poignée pour cabinets de douche
Handgriff für Duschkabinen

Ручка для душевого угла
cm 3 L x 6 P x 24 H - INT. 14

- 08
- 16 - 25



SL 16

Porta asciugamani snodo 2 aste
Towel rail with 2 adjustable bar
Porte serviettes à 2 barres orientables
Handtuchhalter schwenkbar 2 Stangen

Полотенцедержатель двойной поворотный
cm 4 L x 4/35 P x 9 H

- 08
- 16 - 25



SL 07

Anello porta salviette
Ring serviette holder
Porte serviettes à anneau
Handtuchring

Полотенцедержатель – кольцо
cm 21 L x 10 P x 25 H

- 08
- 16 - 25



SL 09

Porta sapone a parete
Wall mounted soap dish
Porte savon à mur
Seifenschale wandhängend

Настенная керамическая мыльница
cm 12 L x 13 P x 12 H

- 08
- 16 - 25



SL 10

Porta bicchiere a parete
Wall mounted glass holder
Porte verre à mur
Zahnbürstenhalter wandhängend

Настенный керамический стакан
cm 9 L x 12 P x 18 H

- 08
- 16 - 25

FINITURA



CROMO
Chrome
Chrome
Chrom
Хром

08



ORO
Gold
Or
Gold
Золото

16



BRONZO
Bronze
Bronze
Bronze
Бронза

25



Su richiesta si realizzano aste porta asciugamani su misura, 20 gg

Customized towel rails are available on request, 20 days
Des porte-serviettes personnalisés sont disponibles sur demande, 20 jours
Handtuchhalter sind auf Anfrage erhältlich, 20 Tagen

По запросу мы можем производить полотенцедержатели под размер 20 дней



- 08 30 → 44 cm
- 08 46 → 100 cm
- 16 - 25 30 → 44 cm
- 16 - 25 46 → 100 cm



SL 30

Dosatore sapone a parete
Wall mounted soap dispenser
Porte savon liquid à mur
Seifenspender wandhängend

Настенный дозатор
cm 12 L x 13 P x 21 H

- 08
- 16 - 25



SL 15

Porta sapone + Porta bicchiere da appoggio
Soap dish + Glass holder
Porte savon + Porte verre
Seifenschale + Zahnbürstenhalter freistehend

Настольная мыльница + стакан
cm Ø 12,5 x 25 L x 18 H

- 08
- 16 - 25



SL 13

Porta accappatoio
Robe hook
Porte peignoir
Bademantelhaken

Крючок
cm 5 L x 7 P x 11 H

- 08
- 16 - 25



SL 11

Porta rotolo
Paper holder
Porte rouleau
Papierrollenhalter

Бумагодержатель
cm 5 L x 7 P x 11 H

- 08
- 16 - 25

Complementi / complements / compléments / complements / Дополняет



> pag. 268



> pag. 278



> pag. 287



> pag. 392



> pag. 302

Solida sublimazione materica



SOLUZIONI D'ARREDO

Designer: Stilhaus, Settimelli, Lenarda

Fuori misura: Sì

*IMBALLI: per questi articoli si
provvederà al recupero di €10,00 a
spedizione

Designer: Stilhaus, Settimelli, Lenarda

Customized: Yes

PACKAGING: for these items you we will
add €10.00 for shipment

Designer: Stilhaus, Settimelli, Lenarda

Personnalis : Oui

EMBALLAGE: pour cette articles nous allons
debiter €10,00 en facture

Designer: Stilhaus, Settimelli, Lenarda

Kundenwunsche: Ja

Verpackungen: f r den Versand berechnen
wir Ihnen 10 € extra

Разработка дизайна: Stilhaus,

Settimelli, Lenarda

Негабаритный: да

MURANO'S [design Alessandro Lenarda]

Serie in cristallo puro

Crystal set
Série en cristal
Serie aus Kristallglas
Серия из стекла

891

Lavabo quadro in cristallo puro con ghiera

Square crystal wash basin with ferrule
Lavabo en cristal avec virale
Quadratischer Waschtisch aus Kristallglas mit Zwinge
Квадратная раковина из стекла
cm 50 x 43 P x 14 H

• 01

1030 [design Alessandro Lenarda]

Lavabo Sagomato in cristallo puro

Shaped crystal wash basin
Lavabo en cristal
Waschbecken aus reinem Kristallglas
Раковина фигурная прозрачная
cm 51 L x 39 P x 15 H

• 01

*** RAC 488**

Piletta di scarico lavabo Up&Down 1" ¼
washbasin drain Up&Down 1" ¼
Vidage Up&Down pour lavabo 1" ¼
Ablaufventil Up&Down 1" ¼
Слив 1 ¼"
cm 6 H

*** Necessaria**

Needed
Nécessaire
Erforderlich
необходимо

Il lavabo Murano's è un articolo realizzato in pasta di vetro. E' la massa vetrosa variegata, di cui esso è composto, a rendere ciascun manufatto un pezzo unico. La presenza di bolle o righe, evidenziano l'artigianalità del prodotto. L'articolo è conforme alla normativa UNI EN 14688 che specifica i requisiti funzionali, e i relativi metodi di prova di lavabi per impieghi domestici.

The Murano's washbasin is an article made of glass paste. His natural glass makes each piece a single particular piece. The presence of bubbles or rows highlight the craftsmanship of the product. The item is conform on the norm UNI EN 14688, that specifics functional requirements together with test methods for wash basins used for domestic purposes.

Le lavabo de Murano est un article en pâte de verre. Son verre naturel fait de chaque pièce une pièce unique. La présence de bulles ou de rangs met en évidence que c'est un produit artisanal. L'article est conforme à la norme UNI EN 14688, qui spécifie les exigences fonctionnelles avec méthodes d'essai pour les lavabos utilisés à des fins domestiques.

Der Waschtisch von Murano ist ein Artikel aus Glaspaste. Sein natürliches Glas macht jedes Stück zu einem Einzelstück. Das Vorhandensein von Blasen oder Reihen unterstreicht die Handwerkskunst des Produkts. Der Artikel entspricht der Norm UNI EN 14688, die funktionale Anforderungen zusammen mit Prüfverfahren für Waschbecken für Haushaltszwecke.

Раковина Murano's изготовлена из стеклянной пасты. Ее натуральное стекло делает каждый кусок отдельной фигурой. Наличие пузырьков или рядов подчеркивает мастерство изделия. Товар соответствует требованиям стандарта UNI EN 14688, специфические функциональные требования вместе с методами испытания для раковин для бытовых целей.



891



1030

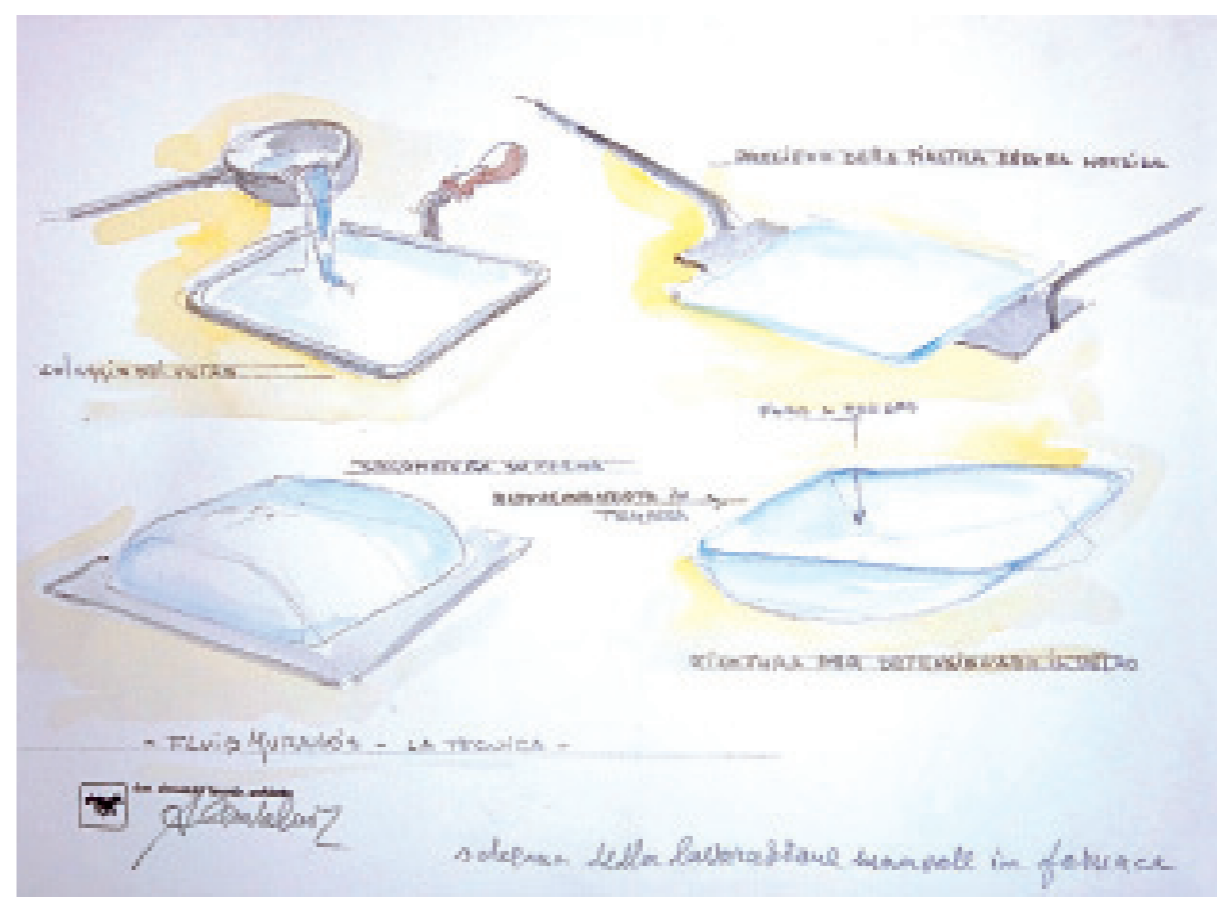
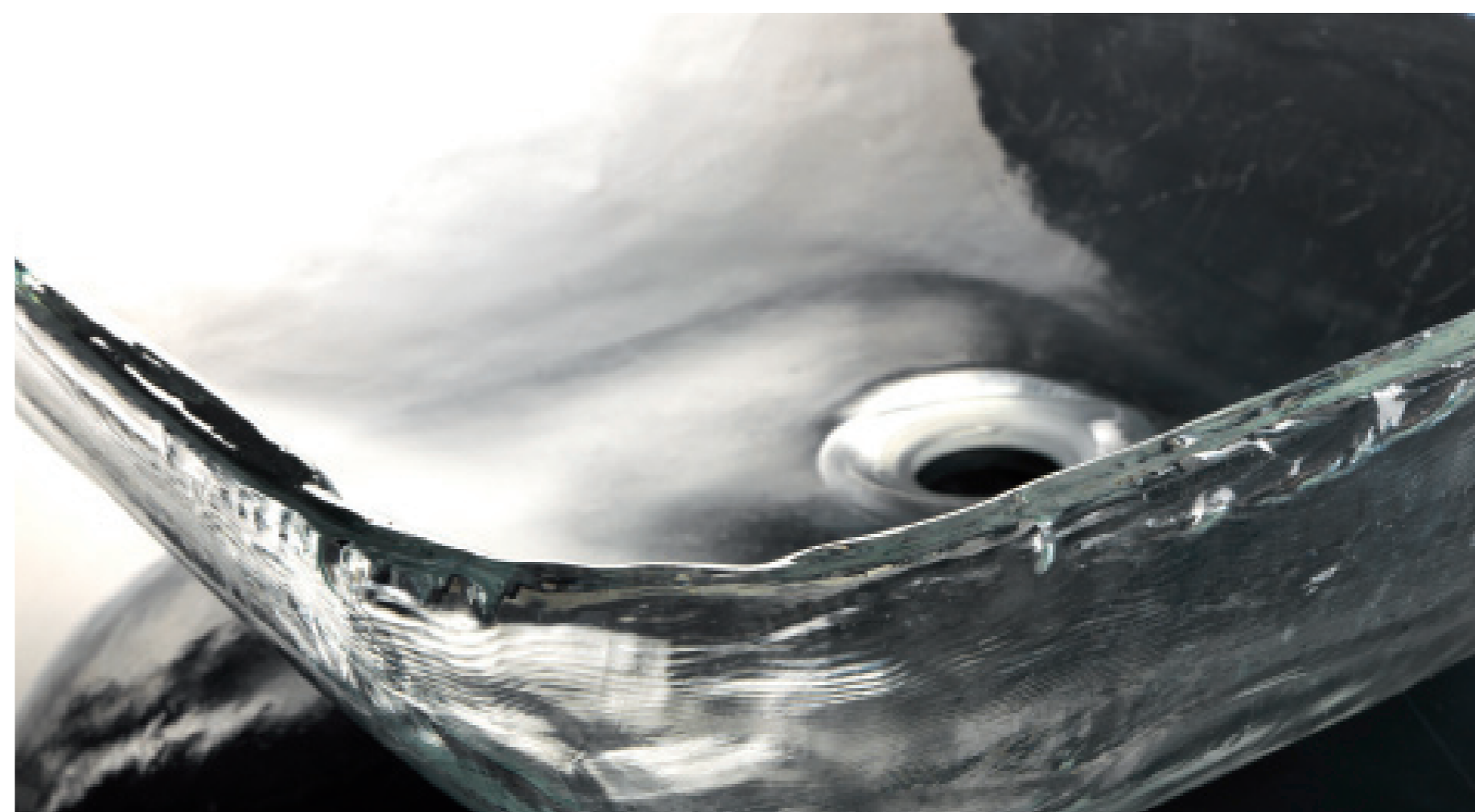
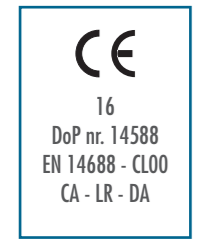

MURANO'S
[design Alessandro Lenarda]

Colaggio della piastra
Casting of the glass
Coulage du verre
Gießen des Glases
литье стекла

Prelievo della piastra
Withdrawal of the plate still soft
L'échantillonnage de la plaque encore molle
Prüfung der noch weichen Platte
Отбор проб пластины еще мягкие

Sagomatura su forma
Shaping of the form
Aménagement de la forme
Gestaltung der Form
Формирование виде

Raffreddamento in tempera
Cooling temperature
Refroidissement à la détente
Abkühlung in Tempera
охлаждение темперой

Ricottura per detensionare il vetro
Annealing of glass
Recuit de verre
Tempern von Glas
Отжиг стекла

1111

Specchio con pensile
Cut mirror with wall unit
Miroir coupé avec suspendu
Ablage aus Edelstahl mit zwei Fächern
Декоративное зеркало
cm 90 L x 17 P x 50 H

• 08

1105

Appliche LED a parete
Wall mounted LED applique
Applique à mur à LED
LED Wandleuchte
Настенные светильники светодиодный
cm 55 L x 9 P x 8 H
CE : V220 IP20 LED 12,5W/12V 4000K

• 08

1093

Specchio ingranditore 3x a parete con supporto
snodato singolo
Wall mounted enlarging mirror 3 x with single
adjustable support
Miroir agrandisseur à mur 3x avec je supporte flexible
Wand-Vergrößerungsspiegel 3 x mit LED-Beleuchtung
Настенное косметическое зеркало с 3-х
кратным увеличением на гибком держателе
Cm ø 14 x 20P Max H14 • Base 5x5

• 08

1133

Struttura porta lavabo in ottone con mensola in vetro
Brass support with glass shelf
Support avec glass étagère
Waschtischkonsole aus Messing mit Glasablage
Каркас из хромированной латуни со
стеклянной полкой
cm 80 L x 46 P x 72 H

• 08

677.48

Lavabo in ceramica
Ceramic washbasin
Lavabo en céramique
Keramik Aufsatzwaschbecken
Керамическая раковина
cm 46 L x 46 P x 14 H

• 08

RAC 393

Sifone tornito in ottone cromato 1" ¼
Chromed brass si phon 1" ¼
Siphon en laiton chromé 1" ¼
Siphon aus verchromtem Messing 1" ¼
Хромированный сифон 1" ¼

• Prezzo composizione completa come foto
(art. 1111-1105-1133-677.48 -RAC393)

Price complete composition like photo
Prix composition complète comme photo
Gesamtpreis der hier abgebildeten Kombination
Цена указана за все позиции, как на фото



1132

Specchio con molatura e luci spot LED
Cut mirror with grind
Miroir avec meulage
Spiegel mit Rundschliff
зеркало со шлифовкой и LED подсветкой
cm 70 x 90
CE : V220 IP21 LED 6,5W/12V 4000K

• 08

1042

Struttura porta lavabo in inox 304 lucido e cristallo
laccato nero
Inox 304 support with black cristal
Support en Inox 304 avec verre étagère noir
Untergestell aus Edelstahl (Inox 304) mit schwarzer
Glasablage
консоль из полированной нержавеющей
стали 304 и черными кристаллами
cm 80 L x 50 P x 82 H

• 08

903

Specchio ingranditore bifacciale 3x a parete
Wall mounted double face enlarging mirror 3x
Miroir agrandisseur double visage à mur 3x
Wandspiegel Vergrößerung 3x doppelseitig
Настенное косметическое зеркало с 3-х
кратным увеличением и реверсным
механизмом
cm Ø 18 x 60 P max x 40 H • INT 130

• 08

1157

Lavabo sottopiano in ceramica
Untop washbasin
Lavabo en céramique
Keramik Aufsatzwaschbecken
раковина керамическая под столешницу
cm 56 L x 37 P x 20 H

• 08

RAC 393

Sifone tornito in ottone cromato 1" ¼
Chromed brass si phon 1" ¼
Siphon en laiton chromé 1" ¼
Siphon aus verchromtem Messing 1" ¼
Хромированный сифон 1" ¼

• 08

• Prezzo composizione completa come foto
(art. 1157 - 1132 - 1042 - RAC393)

Price complete composition like photo
Prix composition complète comme photo
Gesamtpreis der hier abgebildeten Kombination
Цена указана за все позиции, как на фото



895 [design Massimiliano Settimelli]

LUI specchio sagomato filo lucido
 Lui cut mirror with shine edge
 Lui miroir coupé avec bord brillant
 Lui geformter Spiegel mit glänzendem Rand
 Зеркало в виде мужского лица
 cm 76 L x 65 H

896 [design Massimiliano Settimelli]

LEI specchio sagomato filo lucido
 Lei cut mirror with shine edge
 Lei miroir coupé avec bord brillant
 Lei geformter Spiegel mit glänzendem Rand
 Зеркало в виде женского лица
 cm 76 L x 65 H

913 [design Massimiliano Settimelli]

NUVOLA applique
 NUVOLA applique
 NUVOLA applique
 NUVOLA Wandleuchte
 Настенный светильник в виде облака
 cm 25 L x 8 P x 20 H
CE: V 220/12v IP20 G9 35Wx2

• 08

Piano in legno idrorepellente bianco, tortora, rovere
 Waterproof wood top
 Plan en bois impermeable
 Wasserabweisende Holzplatte
 Столешница из дерева с водоотталкивающим покрытием

- 892 cm 70Lx50Px12H
- 893 cm 90Lx50Px12H
- 894 cm 120Lx50Px12H

897

Staffe porta lavabo
 Support for wood top
 Supports pour plan en bois
 Waschtischkonsolen
 Кронштейны для столешницы
 cm 5 L x 30 P x 10 H

• 01

830

Lavabo in ceramica tondo
 Round ceramic washbasin
 Lavabo ronde en céramique
 Keramik Aufsatzwaschbecken rund
 Круглая керамическая раковина
 cm 40 Ø x 15 H

- 08 bianco / white / blanc / weiß/белый
- 08 nero / black / noir / schwarz/черный

• **Prezzo composizione completa come foto**
 (art. 895 - 896 - 913 - 894 - 897 - 830x2)
 Price complete composition like photo
 Prix composition complète comme photo
 Gesamtpreis der hier abgebildeten Kombination
 Цена указана за все позиции, как на фото

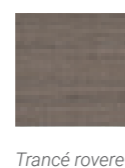
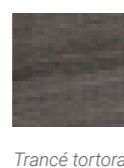

Ceramica - Nero
 Ceramic - Black
 Céramique - Noir
 Keramik - Schwarz
 Керамика - Черный



Ceramica - Bianco
 Ceramic - White
 Céramique - Blanc
 Keramik - Weiß
 Керамика - Белый

1041

Specchio Retroilluminato LED
 Mirror with Led light
 Miroir avec la Led lumière
 Spiegel mit Led Hinterleuchtung
 Прямоугольное зеркало с внутренней подсветкой и алюминиевым обрамлением
 cm 80 L x 100 H
CE: Led 13 W - V 220 - IP21

892 - 893 - 894

Piano in legno idrorepellente bianco, tortora, rovere
 Waterproof wood top
 Plan en bois impermeable
 Wasserabweisende Holzplatte
 Столешница из дерева с водоотталкивающим покрытием

- 892 cm 70Lx50Px12H
- 893 cm 90Lx50Px12H
- 894 cm 120Lx50Px12H

897

Staffe porta lavabo
 Support for wood top
 Supports pour plan en bois
 Waschtischkonsolen
 Кронштейны для столешницы
 cm 5 L x 30 P x 10 H

• 01

891 [design Alessandro Lenarda]

MURANO'S Lavabo quadro in cristallo puro con ghiera
 Square Murano's crystal wash basin with ferrule
 Lavabo en cristal de Murano avec virole
 Quadratischer Waschtisch aus Kristallglas mit Zwinge
 Раковина из мурановского стекла
 cm 50 x 43 P x 14 H

*** RAC 488**

Piletta di scarico lavabo Up&Down 1" ¼
 washbasin drain Up&Down 1" ¼
 Vidage Up&Down pour lavabo 1" ¼
 Ablaufventil Up&Down 1" ¼
 Слив 1 ¼"
 cm 6 H

*** Necessaria**
 Needed
 Nécessaire
 Erforderlich
 необходимое

• **Prezzo composizione completa come foto**
 (art. 1041 - 893 - 897 - 891 - RAC488)
 Price complete composition like photo
 Prix composition complète comme photo
 Gesamtpreis der hier abgebildeten Kombination
 Цена указана за все позиции, как на фото

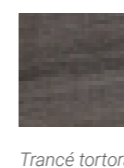
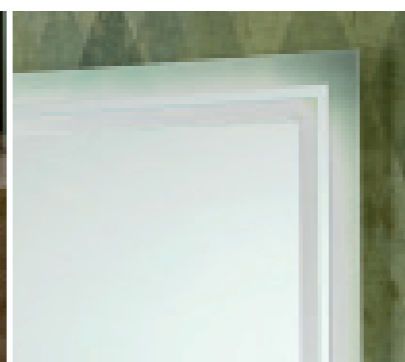
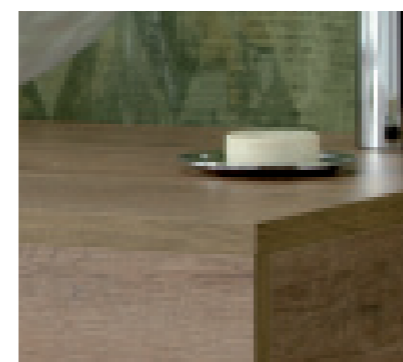

497

Specchio rotondo filo lucido
Round mirror shine edge
Miroir rond bord brillant
Runder Spiegel mit mit glänzendem Rand
Овальное зеркало
cm 50 Ø

774

Appliche LED a parete
Wall mounted LED applique
Appliche à mur à LED
LED Wandleuchte
Настенный светильник
cm 10 L x 15 P x 15 H
CE: V 220/12v IP44 G9 3W 3000K

783

Specchio ingranditore 3x da parete con illuminazione
Wall mounted enlarging mirror 3x with light
Miroir agrandisseur à mur 3x avec éclairage
Wandspiegel Vergrößerung 3x mit Beleuchtung
Увеличительное зеркало с подсветкой
cm Ø 22 x 40 P max

• 08

812

Vasca di vetro con ghiera di fissaggio
Glass washbasin with fixing ring
Lavabo en verre avec anneau de fixation
Glas Aufsatzwaschbecken rund mit Distanzring
Стеклованна раковина матовая
cm 37 Ø x 17 H

• Satinato/satin/satin/satiniert/Хром

813

Supporto in acciaio con foro rubinetteria
Stainless steel wall bearing with hole for tap
Support en acier inox avec trou pour robinet
Wandhalterung aus Edelstahl für Glaswaschbecken mit Loch
Настенный фиксатор для сифона
cm 32 P x 10 L x 10 H fori Ø 4,5/3,2

RAC 488

Piletta di scarico lavabo Up&Down 1" ¼
Washbasin drain Up&Down 1" ¼
Vidage Up&Down pour lavabo 1" ¼
Ablaufventil Up&Down 1" ¼
Дренажного отверстия умывальник вверх и вниз 1 ¼"
cm 6 H

RAC 393

Sifone tornito in ottone cromato 1" ¼
Chromed brass si phon 1" ¼
Siphon en laiton chromé 1" ¼
Siphon aus verchromtem Messing 1" ¼
Хромированный сифон 1 ¼"

• Prezzo composizione completa come foto
(art. 774 x 2 - 497 - 812 - 813 - RAC 393 - RAC 488)
Price complete composition like photo
Prix composition complète comme photo
Gesamtpreis der hier abgebildeten Kombination
Цена указана за все позиции, как на фото



550

Specchio con contenitore in acciaio inox
Mirror with container in stainless steel
Miroir avec conteneur en acier inox
Spiegelschrank Edelstahl
Зеркальный шкаф из нержавеющей стали
cm Ø 60 x 14 P
• filo lucido/shine edge/bord brillant/ glänzender Rand / провол полированный

502

Appliche con 2 lampade alogene e trasformatore
Appliche with 2 alogen lamps and transformer
Appliche avec 2 lampes halogène et transformateur
Wandleuchte mit 2 Halogenlampen und Trafo
2 галогеновые лампы и трансформатор
cm 6 L x 2,5 P
CE: V 220/12v IP20 G4 20Wx2

812

Vasca di vetro con ghiera di fissaggio
Glass washbasin with fixing ring
Lavabo en verre avec anneau de fixation
Glas Aufsatzwaschbecken rund mit Distanzring
Стеклованна раковина
cm 37 Ø x 17 H
• Satinato/satin/satin/satiniert/Хром
• Colorato/colored/coloré/farbig/цветной

814

Supporto in acciaio inox senza foro rubinetteria
Stainless steel wall bearing without hole for tap
Support en acier inox sans trou pour robinet
Wandhalterung aus Edelstahl für Glaswaschbecken ohne Loch
Настенный фиксатор для сифона
cm 30 P x 10 L x 10 H foro ø 4,5

RAC 488

Piletta di scarico lavabo Up&Down 1" ¼
Washbasin drain Up&Down 1" ¼
Vidage Up&Down pour lavabo 1" ¼
Ablaufventil Up&Down 1" ¼
Дренажного отверстия умывальник вверх и вниз 1 ¼"
cm 6 H

RAC 393

Sifone tornito in ottone cromato 1" ¼
Chromed brass si phon 1" ¼
Siphon en laiton chromé 1" ¼
Siphon aus verchromtem Messing 1" ¼
Хромированный сифон 1 ¼"

• Prezzo composizione completa come foto
(art. 502 - 550 - 812 - 814 - rac393 - rac488)
Price complete composition like photo
Prix composition complète comme photo
Gesamtpreis der hier abgebildeten Kombination
Цена указана за все позиции, как на фото



Blu satinato
Blue satin
Satin bleu
Blau satiniert
синий сатин



Rosso satinato
Red satin
Satin rouge
Rot satiniert
красный сатин



Arancio satinato
Orange satin
Satin orange
Orange satiniert
красный сатин



Bianco satinato
White satin
Satin blanc
Weiß satiniert
Белая атласная



Verde satinato
Green satin
Satin vert
Grün satiniert
зеленый сатин

1073

Specchio con mensola
Mirror with shelf
Miroire avec étagère
Spiegel mit Ablage
Зеркало с полкой
cm 50 L x 70H x 12 P

1063

Applique per specchio a led
Led mirror lamp
Lampe a Led pour miroir
LED Leuchte für Spiegel
Светодиодный настенный
светильник для зеркала
cm 40 L x 4H x 6 P
CE : V 220 IP 44 4,8 W 4000K

• 08

1056

Contentitore inox
Inox container
Élément mural en acier
Wandschrank aus Inox
Контейнер из нержавеющей стали
cm 18 L x 10 P x 18 H

• 55

1057

Contentitore inox
Inox container
Élément mural en acier
Wandschrank aus Inox
Контейнер из нержавеющей стали
cm 36 L x 10 P x 18 H

• 55

1058

Contentitore inox con porta salviette
Inox container with towerrail
Élément mural en acier avec porte serviettes
Wandschrank aus Inox mit Handtuchhalter
Контейнер из нержавеющей стали с
полотенцедержателем
cm 36 L x 10 P x 28 H

• 55

677.48

Lavabo in ceramica
Ceramic washbasin
Lavabo en céramique
Keramik Aufsatzwaschbecken
Керамическая раковина
cm 46 L x 46 P x 15 H

• 01

867

Struttura porta lavabo con porta asciugamani
Support with towelholder
Structure avec porte serviette
Struktur mit Handtuchhalter
Структура с полотенцем
cm 45 L x 45 P x 72 H

• 08



852

Base inox con ruote, 4 cassetti
Unit on wheels with 4 drawers
Armoire d'appoint inox sur roulettes, 4 tiroirs
Rollenschrank aus Edelstahl, 4 Schubladen
Передвижная банкетка с 4-мя
выдвижными ящиками
cm 35 L x 30 P x 81 H

853

Base inox con ruote, 2 cassetti, 1 anta vetro
Two drawers + one door on wheels
Armoire d'appoint inox sur roulettes, 2 tiroirs,
1 porte en verre
Rollenschrank aus Edelstahl, 2 Schubladen
und 1 Glastür
Передвижная банкетка с 2-мя выдвижными
ящиками и 1-й стеклянной распашной
дверцей
cm 35 L x 30 P x 81 H

854

Base inox con ruote, 1 cassetto, 1 anta vetro
One drawer + one door on wheels
Armoire d'appoint inox sur roulettes, 1 tiroir,
1 porte en verre
Rollenschrank aus Edelstahl, 1 Schubladen
und 1 Glastür
Передвижная банкетка с 1-м выдвижным
ящиком и 1-й стеклянной распашной
дверцей
cm 35 L x 30 P x 81 H

850

Colonna rotante inox con specchio
Stainless steel turning cabinet with mirror
Armoire tournant en inox avec miroir
Drehbarer Spiegel mit Edelstahlstange
Поворотная колонна на ножке с зеркалом
cm 25 L x 15 P x 165 H



0 01

Specchio ovale molato
 Cut ovale mirror with grind
 Miroir ovale coupé avec meulage
 Ovaler Spiegel mit Facettenschliff
 Овальное зеркало
 cm 65 x 90

EL 03.2 ELITE

Applique doppia, paralume P
 Applique with 2 lamps, lampshade P
 Applique avec 2 lampe, abat-jour P
 Wandleuchte doppelt, Lampenglass P
 Настенные 2 лампы с абажуром
 cm 36 L x 15 P x 16 H
 CE : V 220 IP 20 40 Wx2

- 08
- 02
- 16-25-26

1047

Struttura porta lavabo in ottone con mensola in vetro
 Brass support with glass shelf
 Support avec glass étagère
 Waschtischkonsole aus Messing mit Glasablage
 Каркас из хромированной латуни со
 стеклянной полкой
 cm 74 L x 46 P x 82 H

- 08

1048

Lavabo in ceramica in stile
 Ceramic washbasin
 Lavabo en céramique
 Waschtisch aus Keramik im klassischen Stil
 Керамическая раковина
 cm 102 L x 62 P x 17 H

- 01

RAC 393

Sifone tornito in ottone cromato 1" ¼
 Chromed brass si phon 1" ¼
 Siphon en laiton chromé 1" ¼
 Siphon aus verchromtem Messing 1" ¼
 Хромированный сифон 1" ¼

• Prezzo composizione completa come foto
 (art. 0 01 - EL03.2 - 1047 - 1048 - RAC 393)
 Price complete composition like photo
 Prix composition complète comme photo
 Gesamtpreis der hier abgebildeten Kombination
 Цена указана за все позиции, как на фото

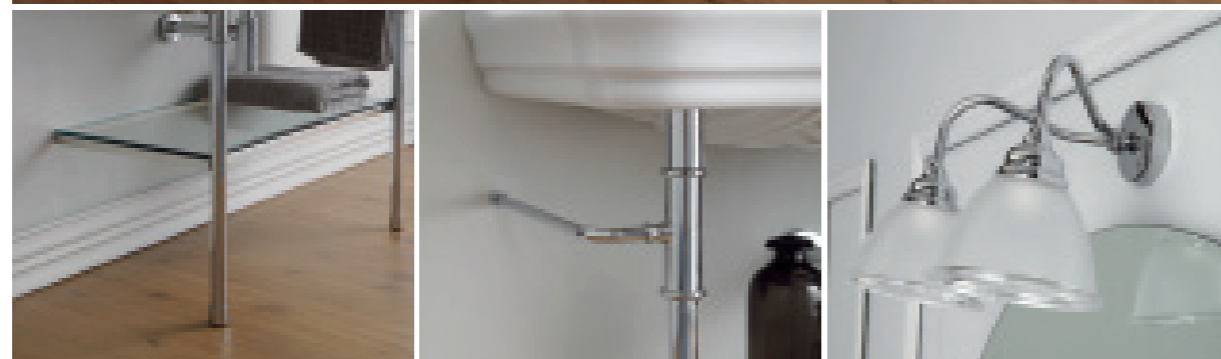

906

Specchio rettangolare con molatura a bastone
 Cut rectangular mirror with grino
 Miroir rectangulaire avec meulage
 Rechteckiger Spiegel mit geschliffenem Rand
 Прямоугольное зеркало
 cm 65 L x 90 H

915

Appique a parete con paralume
 Wall mounted applique with lampshade
 Applique mural avec abat-jour
 Wandleuchte mit Lampenglas
 Настенная лампа с абажуром
 cm 15 L x 15 P x 24 H
 CE : V 220 IP20 40W

- 08 bianco / white / blanc / weiß/белый
- 08 nero / black / noir / schwarz/черный

888

Struttura porta lavabo in ottone con mensola in vetro
 Brass support with glass shelf
 Support avec glass étagère
 Waschtischkonsole aus Messing mit Glasablage
 Каркас из хромированной латуни
 со стеклянной полкой
 cm 70 L x 51 P x 83 H

889

Lavabo in ceramica
 Ceramic washbasin
 Lavabo en céramique
 Keramik Waschbecken
 Керамическая раковина
 cm 70 L x 51 P x 3H

- 08 bianco / white / blanc / weiß/белый

RAC 393

Sifone tornito in ottone cromato 1" ¼
 Chromed brass si phon 1" ¼
 Siphon en laiton chromé 1" ¼
 Siphon aus verchromtem Messing 1" ¼
 Хромированный сифон 1" ¼

• Prezzo composizione completa come foto
 (art. 915 x 2 - 906 - 889 - 888)
 Price complete composition like photo
 Prix composition complète comme photo
 Gesamtpreis der hier abgebildeten Kombination
 Цена указана за все позиции, как на фото



968

Specchio molato e inciso
 Bavelled mirror and engraved
 Miroir avec meulage et gravée
 Spiegel mit geätztem Rundschliff
 зеркало скошенное травленое
 cm 70 L x 90 H

1064

Applique orientabile
 Adjustable applique
 Applique réglable
 Wandleuchte verstellbar
 Регулируемый настенный светильник с
 абажуром
 cm 37 L x 22 P x 17 H
 CE: V 220 IP20 G9 3W 3000K

- 08
- 16-25-26

1051

Struttura porta lavabo in ottone con mensola in vetro
 e piano in marmo
 Brass support with glass shelf and marble top
 Support avec glass étagère avec dessus de marbre
 Waschtischkonsole aus Messing mit Glasablage und
 Marmorplatte
 Консоль: керамическая раковина,
 стеклянная полка и мраморная столешница
 cm 60 L x 47 P x 70 H

- 08
- 16-25-26

1053

Lavabo in ceramica tondo
 Round ceramic washbasin
 Lavabo ronde en céramique
 Keramik Aufsatzwaschbecken rund
 Круглая керамическая раковина
 cm 40 ø x 15 H

RAC 393

Sifone tornito in ottone cromato 1" ¼
 Chromed brass si phon 1" ¼
 Siphon en laiton chromé 1" ¼
 Siphon aus verchromtem Messing 1" ¼
 Хромированный сифон 1" ¼

• Prezzo composizione completa come foto
 (art. 968 - 1064 - 1051 - 1053 - RAC 393)
 Price complete composition like photo
 Prix composition complète comme photo
 Gesamtpreis der hier abgebildeten Kombination
 Цена указана за все позиции, как на фото

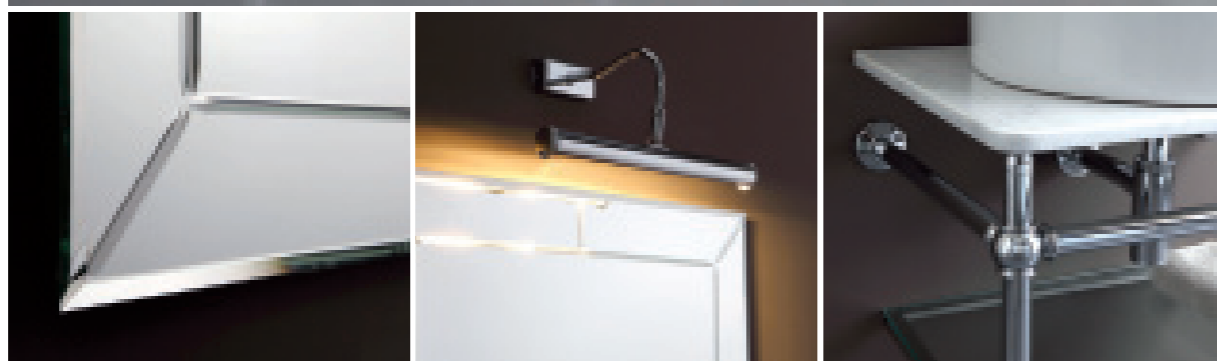

563

Specchio sagomato con molatura a bastone
 Cut mirror with grinding
 Miroir coupé avec meulage
 Geformter Spiegel mit Rundschliff
 Овальное зеркало
 cm 70 L x 90 H

1062 LED

Applique
 Wall mounted applique
 Applique à mur
 Wandleuchte
 Настенные светильники
 cm ø 10 x 19 P x 20 H
 CE: V 220 IP44 3W 3000K

- 08
- 16-25

1049

Struttura porta lavabo in ottone con mensola in vetro
 Brass support with glass shelf
 Support avec glass étagère
 Waschtischkonsole aus Messing mit Glasablage
 Каркас из хромированной латуни
 со стеклянной полкой
 cm 70 L x 51 P x 80 H

- 08
- 16-25

1050

Lavabo in ceramica in stile
 Ceramic washbasin
 Lavabo en céramique
 Waschtisch aus Keramik im klassischen Stil
 Керамическая раковина
 cm 70 L x 58 P x 26 H

- 01

RAC 393

Sifone tornito in ottone cromato 1" ¼
 Chromed brass si phon 1" ¼
 Siphon en laiton chromé 1" ¼
 Siphon aus verchromtem Messing 1" ¼
 Хромированный сифон 1" ¼

• Prezzo composizione completa come foto
 (art. 563 - 1062x2 - 1049 - 1050 - RAC 393)
 Price complete composition like photo
 Prix composition complète comme photo
 Gesamtpreis der hier abgebildeten Kombination
 Цена указана за все позиции, как на фото



F 01

Specchio con laterali in ferro battuto
 Mirror with wrought iron lateral
 Miroir avec des latéraux en fer forgé
 Schmiedeeisener Wandspiegel
 Зеркало с боковым обрамлением из кованого железа
 cm 61 L x 93 H

• 32 - 43 - 51

F 03

Appliche a parete con paralume (mod. B)*
 Wall mounted applique with lampshade (mod. B)*
 Applique mural avec abat-jour (mod. B)*
 Wandleuchte mit Lampenglas (Mod. B)*
 Настенная лампа с абажуром
 cm 10 L x 22 P x 21 H

• 32 - 43 - 51

610.105

Struttura sospesa, ripiano in ferro battuto
 Wall-hung wrought iron structure with shelf
 Structure au mur avec plan en fer forgé
 Wandhängendes Badezimmermöbel mit einer schmiedeeisernen Wandhalterung
 Каркас из кованного железа
 cm 99,5 L x 32 P x 71 H

• 32 - 43 - 51

610.85

Struttura sospesa, ripiano in ferro battuto
 Wall-hung wrought iron structure with shelf
 Structure au mur avec plan en fer forgé
 Wandhängendes Badezimmermöbel mit einer schmiedeeisernen Wandhalterung
 Каркас из кованного железа
 cm 82 L x 32 P x 71 H

• 32 - 43 - 51

457.105

Lavabo consolle in ceramica
 Ceramic console washbasin
 Lavabo en céramique
 Waschtisch aus Keramik
 Керамическая раковина
 cm 104 L x 51 P

• 01

457.85

Lavabo consolle in ceramica
 Ceramic console washbasin
 Lavabo en céramique
 Waschtisch aus Keramik
 Керамическая раковина
 cm 86 L x 51 P

• 01

• Prezzo composizione completa come foto
 (art. f 01 - f 03 x 2 - 610.85 - 487.85)
 Price complete composition like photo
 Prix composition complète comme photo
 Gesamtpreis der hier abgebildeten Kombination
 Цена указана за все позиции, как на фото



798

Specchio tondo con molatura a bastone
 Cut round mirror with grino
 Miroir coupé avec meulage
 Runder Spiegel mit geschliffenem Rand
 Круглое зеркало
 cm 70 ø

i 824

Appliche LED a parete
 Wall mounted LED applique
 Applique mural à LED
 LED Wandleuchte

Настенная лампа с абажуром
 cm 10 L x 24 P x 22 H

CE: V 220/12v IP44 G9 3W 3000K

• 08

• 16 - 25

i 04

Mensola con piano in vetro trasparente
 Shelf with transparent glass plane
 Étagère avec plan en verre transparent
 Ablage aus klarem Glas
 Стеклоянная полка

cm 70 L x 12 P x 10 H

• 08

• 16 - 25

611

Supporti per lavabo con porta asciugamani in ottone
 Brass support for washbasin with towel holder
 Supports pour lavabo avec porte serviette en laiton
 Handtuchhalter aus Messing für Waschtisch
 Держатель для раковины с полотенцедержателем
 cm 68 L x 48 P x 25 H

• 08

• 16 - 25

614

Lavabo in ceramica in stile
 Ceramic washbasin
 Lavabo en céramique
 Waschtisch aus Keramik im klassischen Stil
 Керамическая раковина
 cm 72 L x 59 P

• 08

RAC 393

Sifone tornito in ottone cromato 1" ¼
 Chromed brass si phon 1" ¼
 Siphon en laiton chromé 1" ¼
 Siphon aus verchromtem Messing 1" ¼
 Хромированный сифон 1" ¼

• Prezzo composizione completa come foto
 (art. 798 - i824x2 - 611 - 614 - i04 - RAC 393)
 Price complete composition like photo
 Prix composition complète comme photo
 Gesamtpreis der hier abgebildeten Kombination
 Цена указана за все позиции, как на фото



Proiezione involontaria



SPECCHI

Designer: Stilhaus, Settimelli
Materiale: specchio 5 mm
Fuori misura: Sì

Designer: Stilhaus, Settimelli
Material: Mirror 5 mm
Customized: Yes

Designer: Stilhaus, Settimelli
Matière: Miroir 5 mm
Personnalisé: Oui

Designer: Stilhaus, Settimelli
Material: Spiegel 5 mm
Kundenwunsch: Ja

Разработка дизайна: Stilhaus,
Settimelli
Используемый материал: зеркало
5 mm
Негабаритный: да



WN
 Ecopelle nera con CRYSTALLIZED
 Black eco-leather with CRYSTALLIZED
 Eco-cuir noir avec CRYSTALLIZED
 Eco-Leder schwarz mit CRYSTALLIZED
 Черный кожи Фаух с CRYSTALLIZED

WB
 Ecopelle bianca con CRYSTALLIZED
 White eco-leather with CRYSTALLIZED
 Eco-cuir blanc avec CRYSTALLIZED
 Eco-Leder weiß mit CRYSTALLIZED
 Белый кожи Фаух с CRYSTALLIZED

specchio con cornice cm 5,0 (P)
 mirror with frame cm 5,0 thick (P)
 miroir avec cadre cm 5,0 (P)
 Spiegel mit Rahmen cm 5,0 (P)
 Багетное зеркало см 5,0 (P)

specchio con cornice cm 8,5 (G)
 mirror with frame cm 8,5 thick (G)
 miroir avec cadre cm 8,5 (G)
 Spiegel mit Rahmen cm 8,5 (G)
 Багетное зеркало см 8,5 (G)

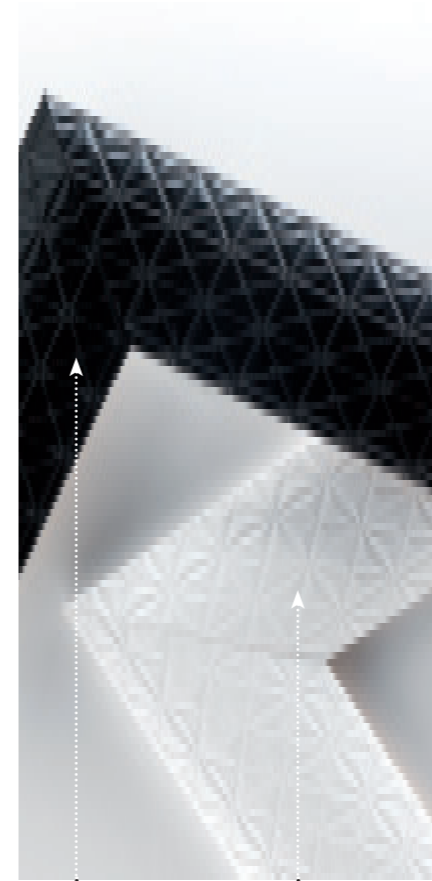

QQ6
 NERO
 Black
 Noir
 Schwarz
 черный

QQ5
 BIANCO
 White
 Blanc
 Weiß
 белый

specchio con cornice cm 5,0 (P)
 mirror with frame cm 5,0 thick (P)
 miroir avec cadre cm 5,0 (P)
 Spiegel mit Rahmen cm 5,0 (P)
 Багетное зеркало см 5,0 (P)

specchio con cornice cm 8,5 (G)
 mirror with frame cm 8,5 thick (G)
 miroir avec cadre cm 8,5 (G)
 Spiegel mit Rahmen cm 8,5 (G)
 Багетное зеркало см 8,5 (G)



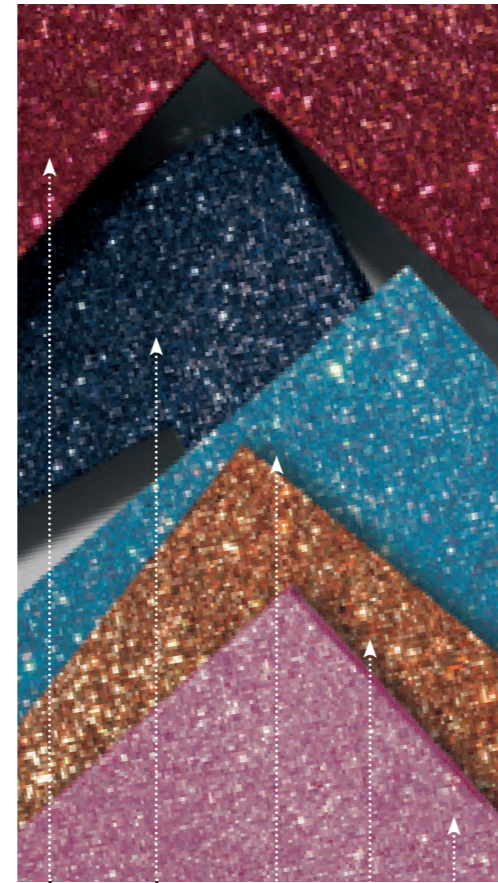
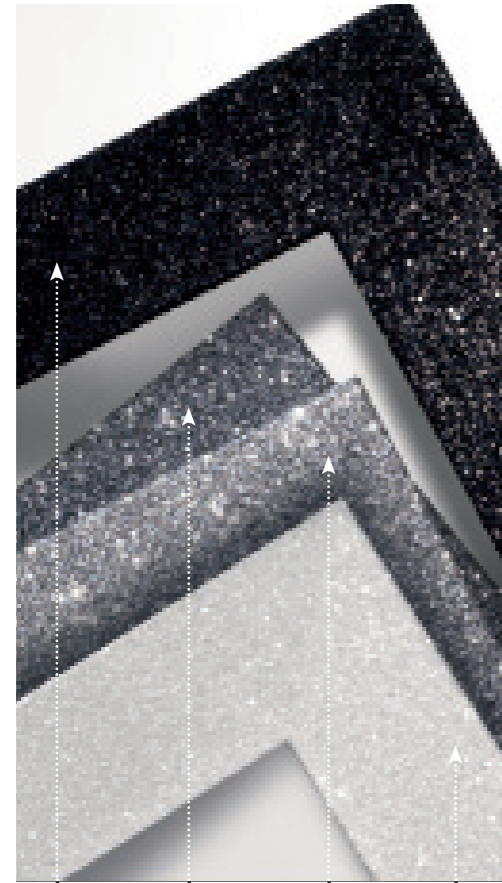
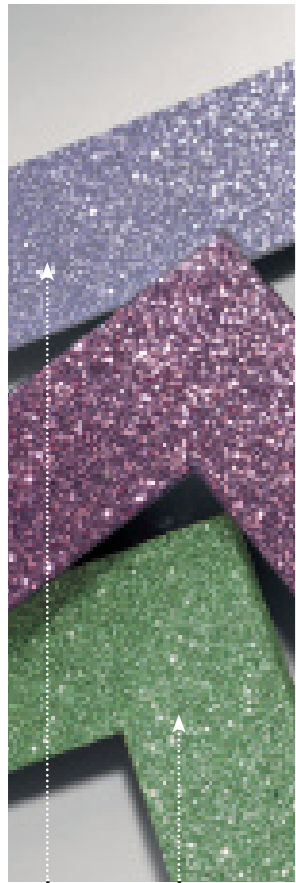

- | | | | | | | | | | | | | |
|--|---|---|---|--|--|---|--|---|---|--|---|--|
| 83
LAVANDA
<i>Lavender</i>
<i>Lavande</i>
<i>Lavendel</i>
<i>лаванда</i> | 84
VERDE GIADA
<i>Jade Green</i>
<i>Vert jade</i>
<i>Jade grün</i>
<i>нефрита</i> | 65
NERO
<i>Black</i>
<i>Noir</i>
<i>Schwarz</i>
<i>черный</i> | 51
BRUNITO
<i>Pewter</i>
<i>Bruni</i>
<i>Bruniert</i>
<i>полированный</i> | 50
ARGENTO
<i>Pewter</i>
<i>Bruni</i>
<i>Bruniert</i>
<i>серебро</i> | 66
BIANCO
<i>White</i>
<i>Blanc</i>
<i>Weiß</i>
<i>лаванда</i> | 52
FUMÈ
<i>Fumè</i>
<i>Fumè</i>
<i>Fumè</i>
<i>копченый</i> | 55
ORO FORTE
<i>Gold</i>
<i>Or</i>
<i>Gold</i>
<i>сильный</i>
<i>золото</i> | 68
ROSSO
<i>Ruby red</i>
<i>Rouge rubis</i>
<i>Rubin rot</i>
<i>рубиново-</i>
<i>красный</i> | 69
BLU
<i>Sapphire blue</i>
<i>Bleu saphir</i>
<i>Saphir blau</i>
<i>синий</i>
<i>сапфир</i> | 80
TURCHESE
<i>Turquoise</i>
<i>Turquoise</i>
<i>Türkis</i>
<i>бирюзовый</i> | 59
RAME
<i>Copper</i>
<i>Cuivre</i>
<i>Kupfer</i>
<i>медь</i> | 81
ROSA
<i>AMETISTA</i>
<i>Pink amethyst</i>
<i>Amethyst rose</i>
<i>розовый</i>
<i>аметист</i> |
|--|---|---|---|--|--|---|--|---|---|--|---|--|

specchio con cornice cm 4,5 (P)
mirror with frame cm 4,5 thick (P)
miroir avec cadre cm 4,5 (P)
Spiegel mit Rahmen cm 4,5 (P)
Багетное зеркало см 4,5 (P)

specchio con cornice cm 8,0 (G)
mirror with frame cm 8,0 thick (G)
miroir avec cadre cm 8,0 (G)
Spiegel mit Rahmen cm 8,0 (G)
Багетное зеркало см 8,0 (G)

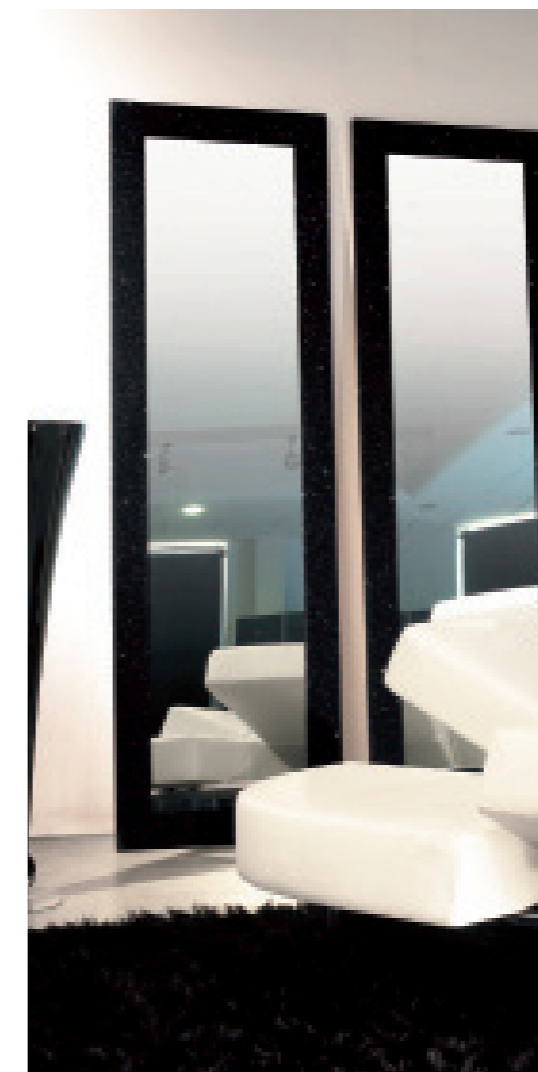
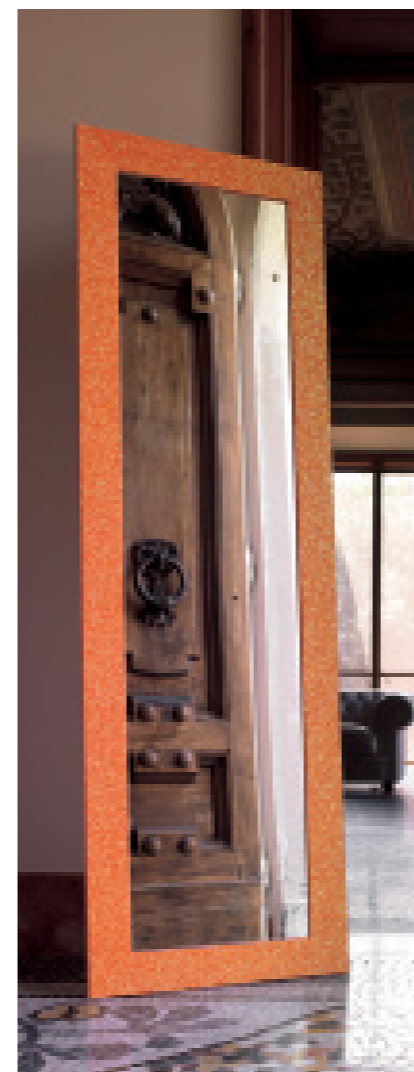

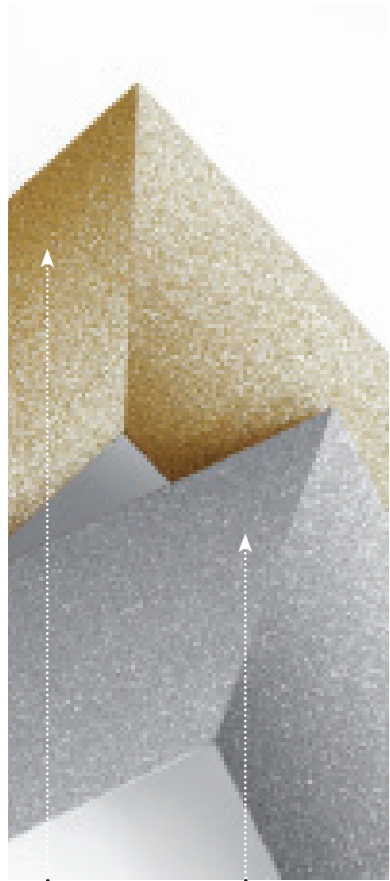

L2
PLATINO
Platinum
Platine
Platin
платина

L1
ARGENTO
Silver
Argent
Silber
серебро

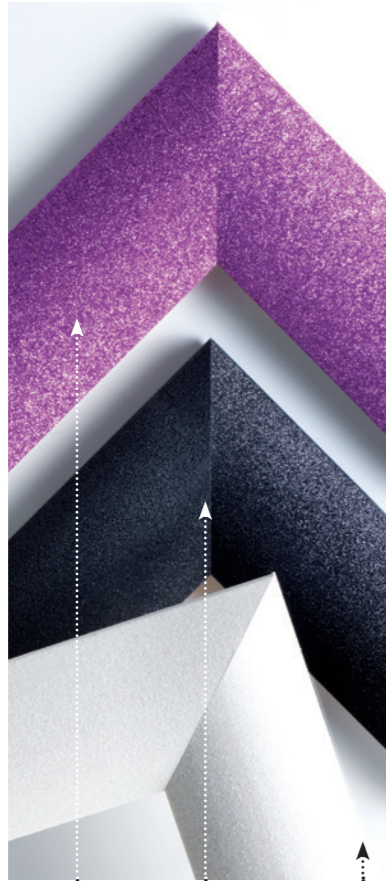

LL8
LAVANDA
Lavander
Lavande
Lavandel
лаванда

LL3
NERO
Black
Noir
Schwarz
черный

LL6
BIANCO
White
Blanc
Weiß
белый

specchio con cornice cm 5,0 (P)
mirror with frame cm 5,0 thick (P)
miroir avec cadre cm 5,0 (P)
Spiegel mit Rahmen cm 5,0 (P)
Багетное зеркало см 5,0 (P)

specchio con cornice cm 8,5 (G)
mirror with frame cm 8,5 thick (G)
miroir avec cadre cm 8,5 (G)
Spiegel mit Rahmen cm 8,5 (G)
Багетное зеркало см 8,5 (G)

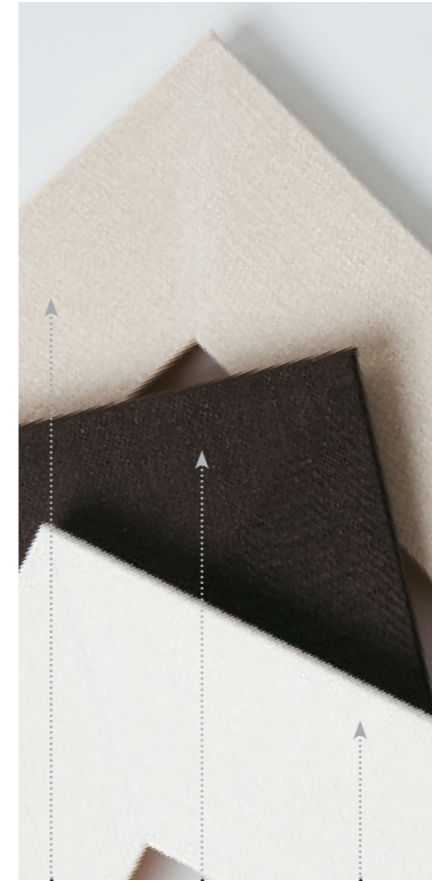

33
GREZZO
Coarse linen
Lin brut
Grobleinen
Грэй

34
TESTA DI MORO
Dark brown
Tête de nègre
Dunkelbraun
Браун

31
BIANCO
White
Blanc
Weiß
белый

specchio con cornice cm 4,5 (P)
mirror with frame cm 4,5 thick (P)
miroir avec cadre cm 4,5 (P)
Spiegel mit Rahmen cm 4,5 (P)
Багетное зеркало см 4,5 (P)

specchio con cornice cm 8,0 (G)
mirror with frame cm 8,0 thick (G)
miroir avec cadre cm 8,0 (G)
Spiegel mit Rahmen cm 8,0 (G)
Багетное зеркало см 8,0 (G)





- | | | | | |
|---|--|--|---|--|
| PA4
ORO
Gold
Or
Gold
золото | PA3
RAME
Copper
Cuivre
Kupfer
Медь | PA1
ARGENTO
Silver
Argent
Silber
серебро | PA5
PLATINO
Platinum
Platine
Platin
платина | PA2
PIOMBO
Lead
Plumb
Blei
вести |
|---|--|--|---|--|

specchio con cornice cm 5,0 (P)
mirror with frame cm 5,0 thick (P)
miroir avec cadre cm 5,0 (P)
Spiegel mit Rahmen cm 5,0 (P)
Багетное зеркало см 5,0 (P)

specchio con cornice cm 8,5 (G)
mirror with frame cm 8,5 thick (G)
miroir avec cadre cm 8,5 (G)
Spiegel mit Rahmen cm 8,5 (G)
Багетное зеркало см 8,5 (G)

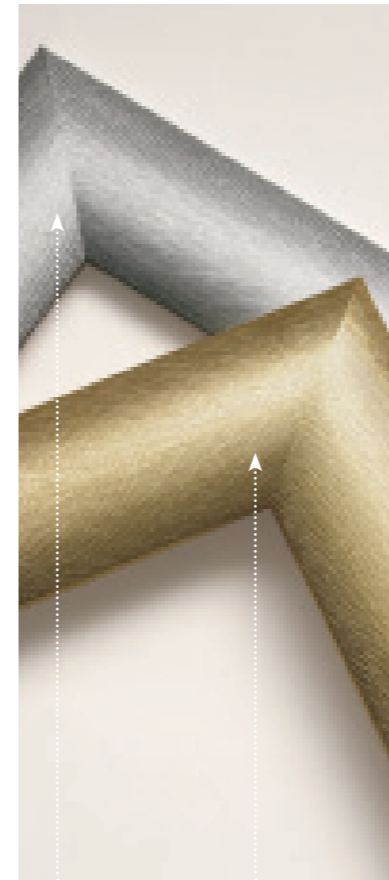
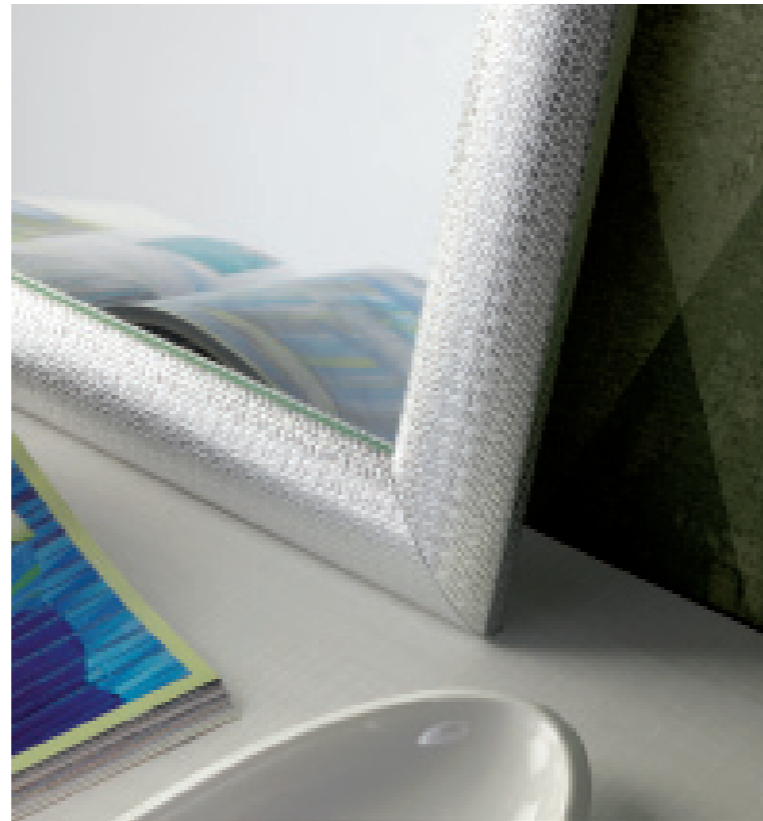

- | | |
|---|--|
| 25
ARGENTO LAMÉ
Silver lamé
Lamé argent
Silber Lamé
серебро | 24
ORO LAMÉ
Gold lamé
Lamé or
Gold Lamé
золото |
|---|--|

specchio con cornice cm 5,0 (P)
mirror with frame cm 5,0 thick (P)
miroir avec cadre cm 5,0 (P)
Spiegel mit Rahmen cm 5,0 (P)
Багетное зеркало см 5,0 (P)

specchio con cornice cm 8,0 (G)
mirror with frame cm 8,0 thick (G)
miroir avec cadre cm 8,0 (G)
Spiegel mit Rahmen cm 8,0 (G)
Багетное зеркало см 8,0 (G)

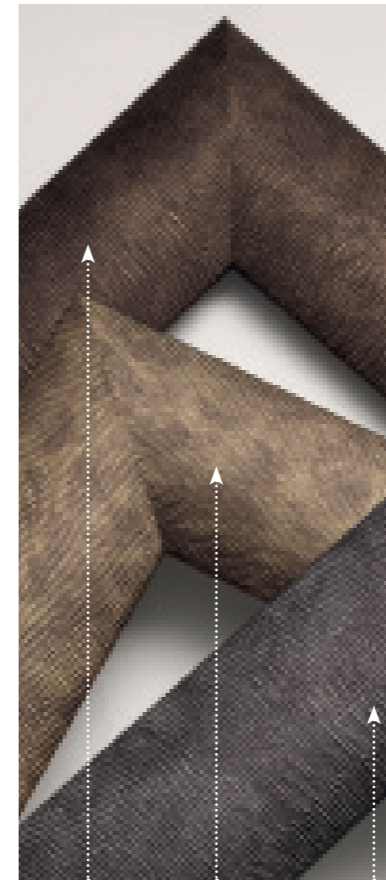

- | | | |
|---|--|---|
| 28
BRONZO
Bronze
Bronze
Bronze
бронза | 27
ORO
Gold
Or
Gold
золото | 26
PIOMBO
Lead
Plomb
Blei
вести |
|---|--|---|





005
ORO
Gold
Or
Gold
золото

06
ARGENTO
Silver
Argent
Silber
серебро

specchio con cornice foglia argento cm 10 - oro
mirror with frame silver - gold leaf
miroir avec cadre feuille d'argent - d'or
Spiegel mit Rahmen Silber - Gold Blatt
Багетное зеркало лист серебро - золото

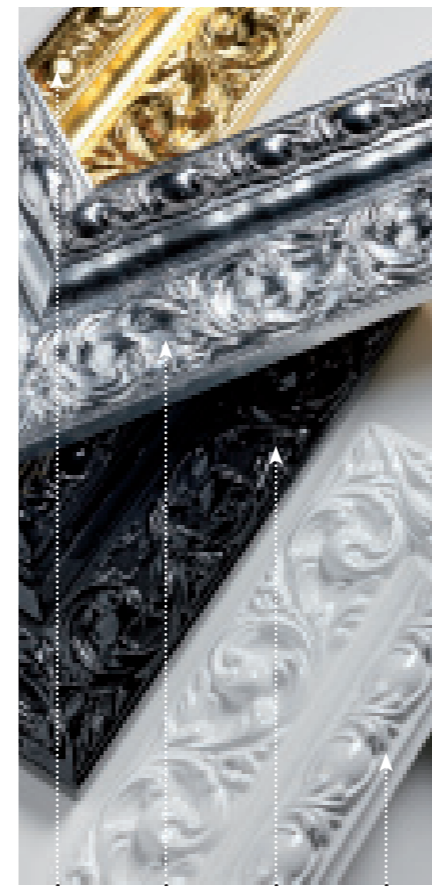

OR
ORO
Gold
Or
Gold
золото

AR
ARGENTO
Silver
Argent
Silber
серебро

08
NERO
Black
Noir
Schwarz
черный

33
BIANCO
White
Blanc
Weiß
белый

specchio con cornice laccato bianco cm 9 - nero
mirror with frame white - black lacquered
miroir avec cadre laqué blanc - noir
Spiegel mit Rahmen Weiß - Schwarz lackiert
Багетное зеркало лаковый белый - черный

specchio con cornice foglia argento cm 9 - oro
mirror with frame silver - gold leaf
miroir avec cadre feuille d'argent - d'or
Spiegel mit Rahmen Silber - Gold Blatt
Багетное зеркало лист серебро - золото





488

Specchio ingranditore 3x a parete con supporto flessibile
 Wall mounted enlarging mirror 3x with flexible support
 Miroir agrandisseur à mur 3x avec je supporte flexible
 Wandspiegel Vergrößerung 3x mit flexibler Wandhalterung
 Настенное косметическое зеркало с 3-х кратным увеличением на гибком держателе
 cm Ø 14 x 14 P • Base Ø 7,5

• 08



23

1035

Specchio ingranditore 3x a parete con supporto snodato singolo
 Wall mounted enlarging mirror 3 x with single adjustable support
 Miroir agrandisseur à mur 3x avec je supporte flexible
 Wand-Vergrößerungsspiegel 3 x mit LED-Beleuchtung
 Настенное косметическое зеркало с 3-х кратным увеличением на гибком держателе
 cm Ø 14 x 20 P Max x H14 • Base Ø 7,5

• 08

• 23

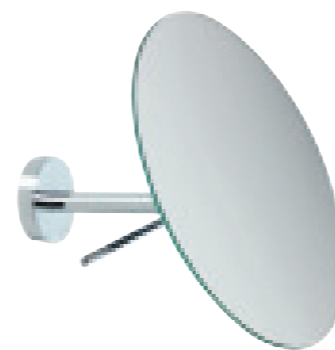

1092

Specchio ingranditore 2x rettangolare a parete
 Wall mounted rectangular enlarging mirror 2x
 Miroir agrandisseur 2x rectangulaire à mur
 Rechteckiger Wandspiegel mit Vergrößerung 2x
 Настенное косметическое зеркало с 2-х кратным увеличением
 cm Ø 20 x 8/18 P • Base Ø 5 x 1 H

• 08



751

Specchio ingranditore 2x rettangolare a parete
 Wall mounted rectangular enlarging mirror 2x
 Miroir agrandisseur 2x rectangulaire à mur
 Rechteckiger Wandspiegel mit Vergrößerung 2x
 Настенное косметическое зеркало с 2-х кратным увеличением
 cm 14 L x 8 P x 20 H • Base 4 L x 2 P x 9 H

• 08



1093

Specchio ingranditore 3x a parete con supporto snodato singolo
 Wall mounted enlarging mirror 3 x with single adjustable support
 Miroir agrandisseur à mur 3x avec je supporte flexible
 Wand-Vergrößerungsspiegel 3 x mit LED-Beleuchtung
 Настенное косметическое зеркало с 3-х кратным увеличением на гибком держателе
 cm 15 L x 6/18 P x 15 H • Base 5 L x 5 H x 1 P

• 08



1091

Specchio ingranditore 2x rettangolare a parete
 Wall mounted rectangular enlarging mirror 2x
 Miroir agrandisseur 2x rectangulaire à mur
 Rechteckiger Wandspiegel mit Vergrößerung 2x
 Настенное косметическое зеркало с 2-х кратным увеличением
 cm 14 L x 8 P x 14 H • Base 5 L x 1 P x 5 H

• 08

POTENZA DI INGRANDIMENTO

MAGNIFICATION POWER / POUVOIR DE GROSSISSEMENT / MACHT DER VERGRÖßERUNG / Увеличение мощности

La calotta concava avvicina l'immagine a una distanza che varia dai 30 cm ai 10 cm, a seconda della potenza di ingrandimento dello specchio.

The concave shell approaches the image at a distance ranging from 30 cm to 10 cm, depending on the magnification power of the mirror.

La coque concave s'approche de l'image à une distance allant de 30 cm à 10 cm, en fonction de la puissance d'agrandissement du miroir.

Die konkave Schale nähert sich dem Bild in einem Abstand von 30 cm bis 10 cm, abhängig von der Vergrößerungsstärke des Spiegels.

Вогнутый колпачок приближает изображение на дистанцию от 30 до 10 см, в зависимости от увеличения мощности зеркала.



2X

ingrandisce circa 2 volte a 30 cm di distanza
 enlarges about 2 times to 30 cm away
 agrandit environ 2 fois à 30 cm
 vergrößert sich ca. 2 mal auf 30 cm
 увеличение примерно в 2 раза на расстоянии 30 см



3X

ingrandisce circa 3 volte a 25 cm di distanza
 enlarges about 3 times to 25 cm away
 agrandit environ 3 fois à 25 cm
 vergrößert sich ca. 3 mal auf 25 cm
 увеличение примерно в 4 раза на расстоянии 20 см



4X

ingrandisce circa 4 volte a 20 cm di distanza
 enlarges about 4 times to 20 cm away
 agrandit environ 4 fois à 20 cm
 vergrößert sich ca. 4 mal auf 20 cm
 увеличение примерно в 4 раза на расстоянии 20 см



6X

ingrandisce circa 6 volte a 10 cm di distanza
 enlarges about 6 times to 10 cm away
 agrandit environ 6 fois à 10 cm
 vergrößert sich ca. 6 mal auf 10 cm
 увеличение примерно в 6 раз на расстоянии 10 см

Solo su articoli 783 e 1036
 only articles 783 and 1036
 seulement article 783 et 1036
 nur artikel 783 mit 1036
 Только арт. 783 и 1036

Solo su articoli 783 e 1036
 only articles 783 and 1036
 seulement article 783 et 1036
 nur artikel 783 mit 1036
 Только арт. 783 и 1036

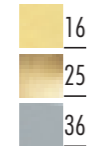

1037

Specchio ingranditore 3x a parete con supporto snodato singolo

Wall mounted enlarging mirror 3x with single adjustable support

Miroir agrandisseur double visage à mur 3x avec je supporte single

Wand-Vergrößerungsspiegel 3x mit LED-Beleuchtung

Настенное косметическое зеркало с 3-х кратным увеличением на гибком держателе

Cm Ø 18 x 24 P • Base Ø 10

- 08
- 16 - 25 - 36

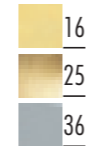

489

Specchio ingranditore bifacciale 3x con supporto snodato

Wall mounted double face enlarging mirror 3x with adjustable support

Miroir agrandisseur double visage à mur 3x avec je supporte réglable

Wandspiegel mit Vergrößerung 3x, doppelseitig und klappbar

Настенное косметическое зеркало с 3-х кратным увеличением и поворотным механизмом

Cm Ø 18 x 26 L x 40 P max • Base Ø 10

- 08
- 16 - 25 - 36

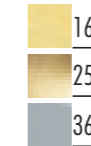

903

Specchio ingranditore bifacciale 3x a parete

Wall mounted double face enlarging mirror 3x

Miroir agrandisseur double visage à mur 3x

Wandspiegel Vergrößerung 3x doppelseitig

Настенное косметическое зеркало с 3-х кратным увеличением и реверсным механизмом

Cm Ø 18 x 60 P max x 40 H • INT 13

- 08
- 16 - 25 - 36



1074

Specchio ingranditore 3x da incollo

Glue fixing enlarging mirror 3x

Miroir agrandisseur 3x par collie

Wandspiegel Vergrößerung 3x mit Klebstoff

Увеличительное зеркало 3x, установка на клей

Также для установки во внутрь душевого угла

Cm Ø 14 x 10 P • Base Ø 5



- 08



1075

Specchio ingranditore 3x per specchio da incollo

Glue fixing enlarging mirror 3x for mirror

Miroir agrandisseur 3x par collie pour miroir

Wandspiegel Vergrößerung 3x mit Klebstoff

Увеличительное зеркало 3x с установкой на зеркало

Cm Ø 18



- 08



1096

Specchio ingranditore 3x per specchio

Glue fixing enlarging mirror 3x for mirror

Miroir agrandisseur 3x par collie pour miroir

Wandspiegel Vergrößerung 3x mit Klebstoff

Увеличительное зеркало 3x с установкой на зеркало

Cm Ø 20 x 3/22 P max • Base 5 L x 1 P x 13 H

- 08





561

Specchio ingranditore 2x quadrato con base
 Square enlarging mirror 2x with base
 Miroir agrandisseur 2x cadré d'appui
 Quadratischer Standspiegel mit Vergrößerung 2x
 Настольное косметическое зеркало с 2-х кратным увеличением
 cm 16 L x 19 P x 30 H - base 10 x 10

• 08



562

Specchio ingranditore 2x rettangolare con base
 Rectangular enlarging mirror 2x with base
 Miroir agrandisseur 2x rectangulaire d'appui
 Rechteckiger Standspiegel mit Vergrößerung 2x
 Настольное косметическое зеркало с 2-х кратным увеличением
 cm 13 L x 9 P x 34 H - base 10 x 10

• 08



1094

Specchio ingranditore 3x bifacciale estensibile con base
 Double face enlarging mirror 3x extensible with base
 Miroir agrandisseur 3x extensible double visage d'appui
 Doppelseitiger Standspiegel mit Vergrößerung 3x ausziehbar
 Настольное косметическое зеркало с 3-х кратным увеличением
 cm Ø 18,5 x 37/50 H • Base Ø 12,5

• 08
 • 16 - 25 - 36

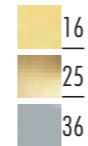

752

Specchio ingranditore 3x bifacciale con base
 Double face enlarging mirror 3x with base
 Miroir agrandisseur 3x double visage d'appui
 Doppelseitiger Standspiegel mit Vergrößerung 3x
 Настольное косметическое зеркало с 3-х кратным увеличением
 cm Ø 18,5 x 40 H • Base 12,5

• 08
 • 16 - 25 - 36

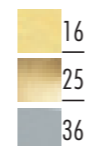

1095

Specchio ingranditore 3x bifacciale con porta make-up
 Double face enlarging mirror 3x with base
 Miroir agrandisseur 3x double visage d'appui
 Doppelseitiger Standspiegel mit Vergrößerung 3x
 Настольное косметическое зеркало с 3-х кратным увеличением
 cm Ø 18 x 50 H • Base 25 L x 15 H

• 08



NT 956

Specchio ingranditore 3X bifacciale con base
 Double face enlarging mirror 3x with base
 Miroir agrandisseur 3x double visage d'appui
 Doppelseitiger Standspiegel mit Vergrößerung 3x
 Настольное косметическое зеркало с 3-х кратным увеличением
 cm Ø 18,5 x 22 L x 51 H • Base Ø 12,5

• 08
 • 16



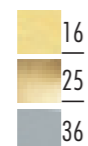
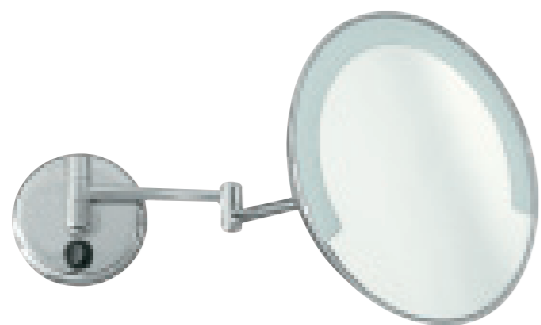

783

Specchio ingranditore 3x da parete con illuminazione
 Wall mounted enlarging mirror 3x with light
 Miroir agrandisseur à mur 3x avec éclairage
 Wandspiegel Vergrößerung 3x mit Beleuchtung



Настенное косметическое зеркало с 3-х кратным увеличением и подсветкой
 cm ø 22 x 40 P max • Base Ø 12,5
 CE: V 220 12V E14 10Wx2

- 08
- 25 - 16 - 36
- SPINA CON CAVO cm 120-180

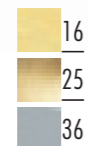
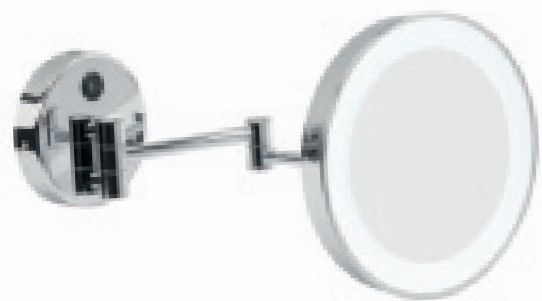

902

Specchio ingranditore 3x con illuminazione a LED
 Wall mounted enlarging mirror 3x with LED light
 Miroir agrandisseur à mur 3x avec éclairage à LED
 Wandspiegel Vergrößerung 3x mit LED Beleuchtung



Настенное косметическое зеркало с 3-х кратным увеличением и подсветкой
 cm ø 24 x 40 P max x 24 H • Base Ø 12 x 2 H
 CE: V 220 12V 4W

- 08
- 36

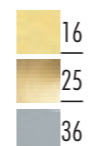

1036

Specchio ingranditore 4x da parete con illuminazione LED
 Wall mounted enlarging mirror 4x with LED light
 Miroir agrandisseur à mur 4x avec LED
 Schwenkbarer Wand-Vergrößerungsspiegel 4x



Настенное косметическое зеркало с 4-х кратным увеличением и подсветкой
 cm ø 22 x 40P Max H22 • Base Ø 12,5
 CE: V 220 12V 4W

- 08
- 26 - 16 - 36



901

Specchio ingranditore 2x con illuminazione a LED
 Wall mounted enlarging mirror 2x with LED light
 Miroir agrandisseur à mur 2x avec éclairage à LED
 Wandspiegel Vergrößerung 2x mit LED Beleuchtung



Настенное косметическое зеркало с 2-х кратным увеличением и подсветкой
 cm 22 L x 39 P x 22 H • Base 12 L x 12 P x 2,5 H
 CE: V 220 12V 4W

- 08
- 36



1097

Specchio ingranditore 3x da parete con illuminazione LED
 Wall mounted enlarging mirror 3x with LED light
 Miroir agrandisseur à mur 3x avec LED
 Schwenkbarer Wand-Vergrößerungsspiegel 3x

Настенное косметическое зеркало с 4-х кратным увеличением и подсветкой
 cm Ø 21 x 39 P • Base Ø 12
 CE: V 220 12V 4W

- 08

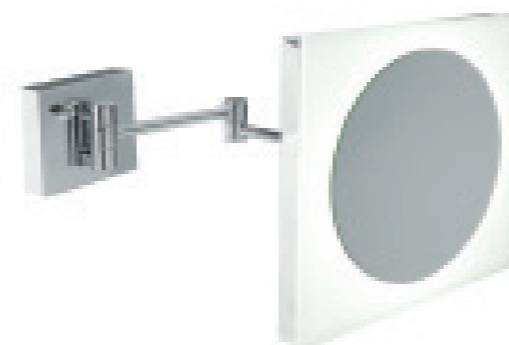

1081

Specchio ingranditore 2x con illuminazione a LED
 Wall mounted enlarging mirror 2x with LED light
 Miroir agrandisseur à mur 2x avec éclairage à LED
 Wandspiegel Vergrößerung 2x mit LED Beleuchtung

Настенное косметическое зеркало с 2-х кратным увеличением и подсветкой
 cm 24 L x 16/40 P x 24 H • Base 12 L x 2,5 P x 12 H
 CE: V 220 12V 4W

- 08





1065  PAG. 272

Specchio filo lucido con ingranditore 2x
 Rectangular mirror with enlarging mirror 2x
 Miroir rectangulaire avec miroir agrandisseur 2x
 Rechteckiger Wandspiegel mit Vergrößerung 2x
 зеркало с LED подсветкой и 2-х кратным увеличением
 cm 112 L x 64 H - ING. Ø 18

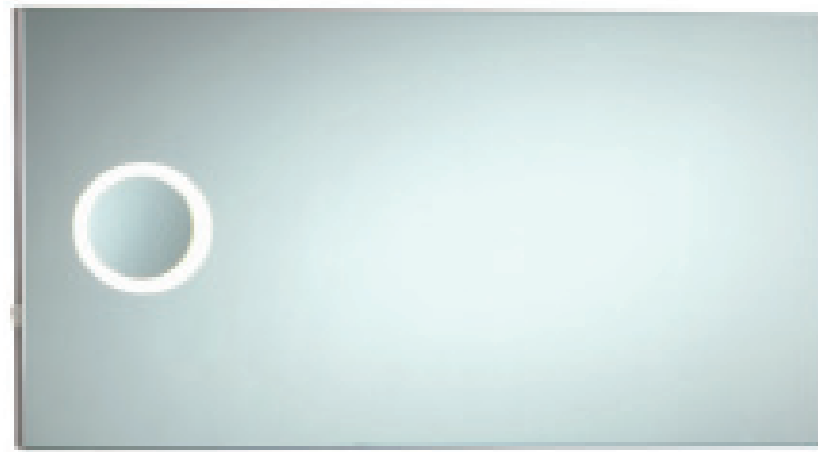

1140  PAG. 272

Specchio filo lucido con ingranditore 2x illuminazione LED
 Rectangular mirror with enlarging mirror 2x LED
 Miroir rectangulaire avec miroir agrandisseur 2x LED
 Rechteckiger Wandspiegel mit Vergrößerung 2x LED
 зеркало с LED подсветкой и 2-х кратным увеличением
 cm 112 L x 64 H - ING. Ø 18
 CE: V 220 12V 4W

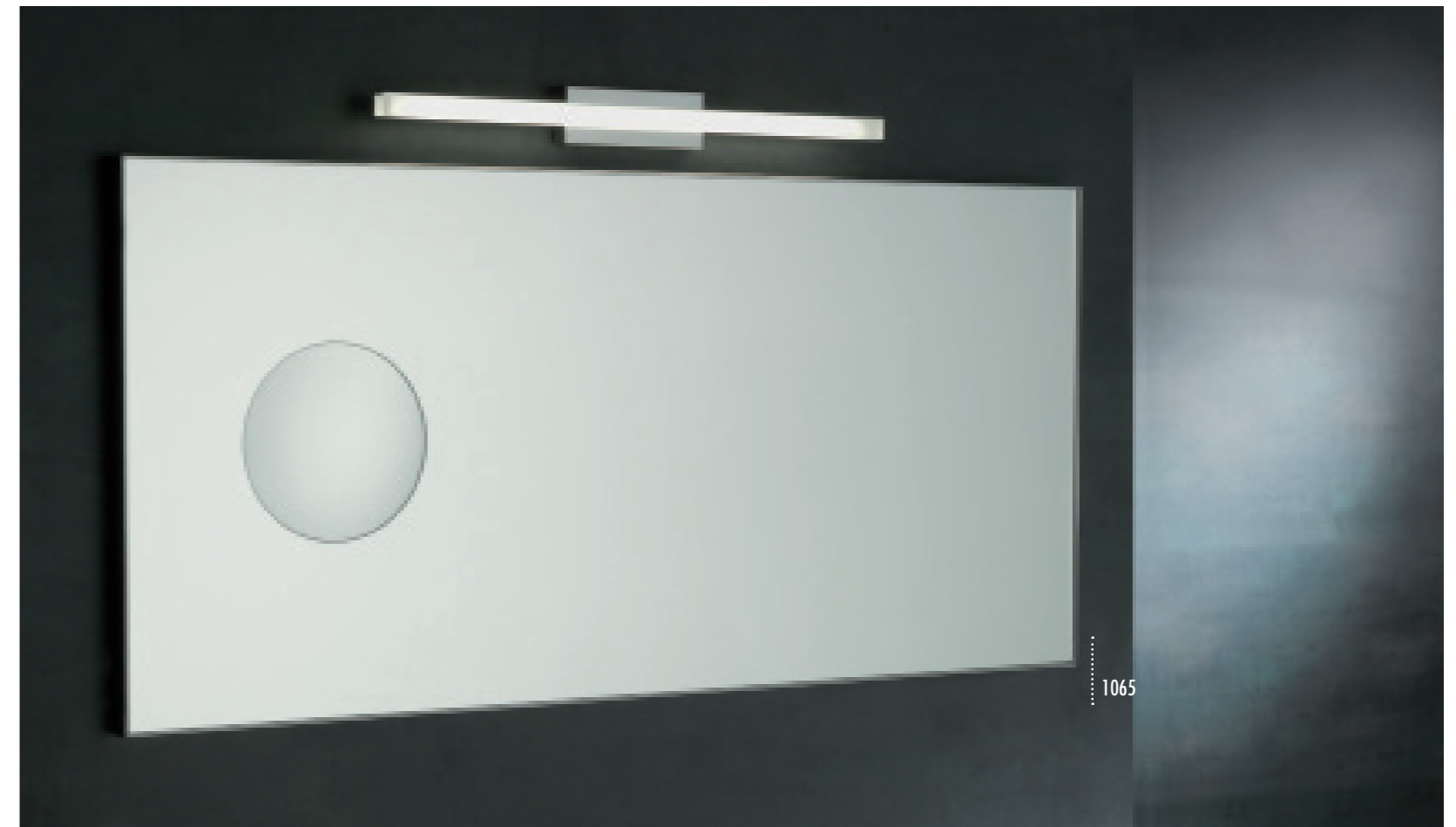



549

Specchio con contenitore in acciaio inox
 Mirror with container in stainless steel
 Miroir avec containeur en acier inox
 Spiegelschrank Edelstahl
 Зеркальный шкаф из нержавеющей стали
 cm 62 L x 14 P x 80 H



• filo lucido/shine edge/bord brillant/glänzender Rand / провод полированный



599

Specchio ad angolo con contenitore in acciaio inox
 Corner mirror with container in stainless steel
 Miroir à angle avec containeur en acier inox
 Eck Spiegelschrank Edelstahl
 Зеркальный шкаф угловой из нержавеющей стали
 cm 41 L x 30 P x 80 H

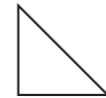

• filo lucido/shine edge/bord brillant/glänzender Rand / провод полированный



550

Specchio con contenitore in acciaio inox
 Mirror with container in stainless steel
 Miroir avec containeur en acier inox
 Spiegelschrank Edelstahl
 Зеркальный шкаф из нержавеющей стали
 cm Ø 60 x 14 P



• filo lucido/shine edge/bord brillant/glänzender Rand / провод полированный



606

Specchio con contenitore in acciaio inox
 Mirror with container in stainless steel
 Miroir avec containeur en acier inox
 Spiegelschrank Edelstahl
 Зеркальный шкаф из нержавеющей стали
 cm 45 L x 14 P x 62 H



• filo lucido/shine edge/bord brillant/glänzender Rand / провод полированный





1073

Specchio con mensola
Cut mirror with shelf
Miroir coupé avec étagère
Geformter Spiegel
Декоративное зеркало
cm 50 L x 12 P x 70 H



• filo lucido/shine edge/bord brillant/glänzender Rand / провод полированный



871

Specchio con porta oggetti scorrevole
Mirror toilet cabinet with sliding drawers
Miroir et tiroirs latérales
Spiegel mit verschiebbarer Ablagefläche
Зеркальный шкаф с выдвижными ящиками с торца
cm 66/111 L x 14 P x 70,5 H



1111

Specchio con pensile
Cut mirror with wall unit
Miroir coupé avec suspendu
Spiegel mit Edelstahl-Ablage
зеркало с крышкой
cm 90 L x 17 P x 50 H



• filo lucido/shine edge/bord brillant/glänzender Rand / провод полированный

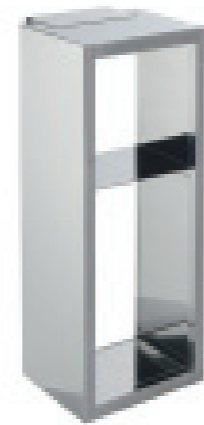

1112

Pensile a 2 piani in inox per specchio
Inox wall unit for mirror
étagère en acier inox à 2 cotes pour miroir
Edelstahl-Ablage mit zwei Fächern
2-х ярусная полка для зеркала
cm 18 L x 14 P x 50 H

• 55





Q 01

Specchio con bordo satinato molato reversibile
 Reversible mirror with satinized edge
 Miroir avec bord satinée réversible
 Rechteckiger Spiegel mit satiniertem Rand
 Прямоугольное зеркало
 cm 65 x 90



678 - 679  Pag. 272

Specchio con cornice cromata reversibile
 Reversible mirror with chromed frame
 Miroir avec cadre chrome réversible
 Spiegel mit verchromtem Rand
 Прямоугольное зеркало



- 678 cm 50 x 70
- 679 cm 50 x 90

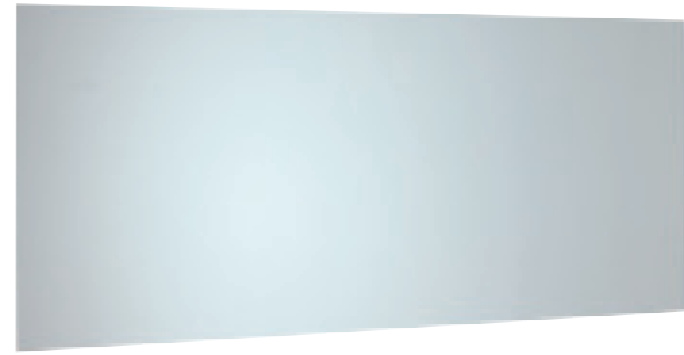

583  Pag. 272

Specchio rettangolare filo lucido reversibile
 Reversible rectangular mirror with shine edge
 Miroir rectangulaire avec bord brillant réversible
 Rechteckiger Spiegel mit glänzendem Rand
 Прямоугольное зеркало
 cm 50 x 105



- 583 reversibile

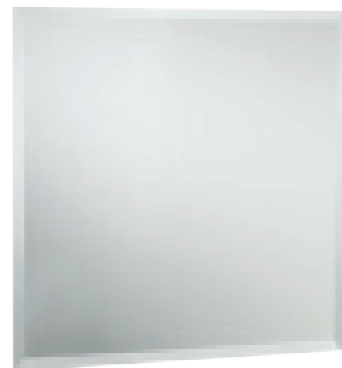

498  Pag. 272

Specchio quadrato
 Square mirror
 Miroir carré
 Quadratischer Spiegel
 квадратное зеркало
 cm 45 x 45



- filo lucido/shine edge/bord brillant/glänzender Rand / провол полированный
- molato (foto)/with grind (photo)/avec meulage (photo)/mit Schiff (Bild)/скошенные



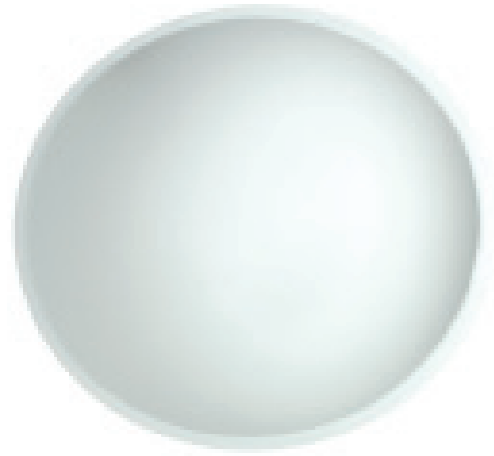

497  Pag. 272

Specchio rotondo
Round mirror
Miroir rond
Runder Spiegel
Круглое зеркало
cm Ø 50



- filo lucido/shine edge/bord brillant/glänzender Rand / провол полированный
- molato (foto)/with grind (photo)/avec meulage (photo)/mit Schiff (Bild) / скошенные



0 01

Specchio ovale molato
Cut ovale mirror with grind
Miroir ovale coupé avec meulage
Ovaler Spiegel mit Facettenschliff
Овальное зеркало
cm 65 x 90

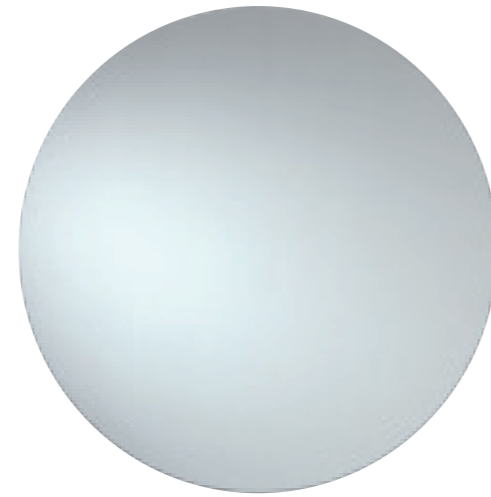

1113  Pag. 272

Specchio rotondo
Round mirror
Miroir rond
Runder Spiegel
Круглое зеркало
cm Ø 60

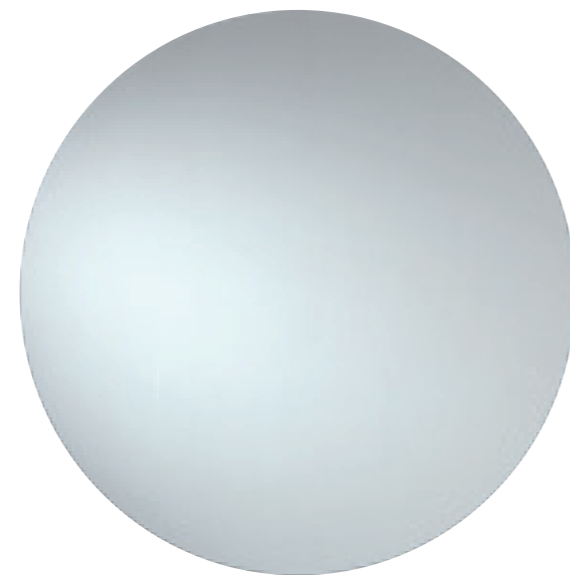

1114  Pag. 272

Specchio rotondo
Round mirror
Miroir rond
Runder Spiegel
Круглое зеркало
cm Ø 70



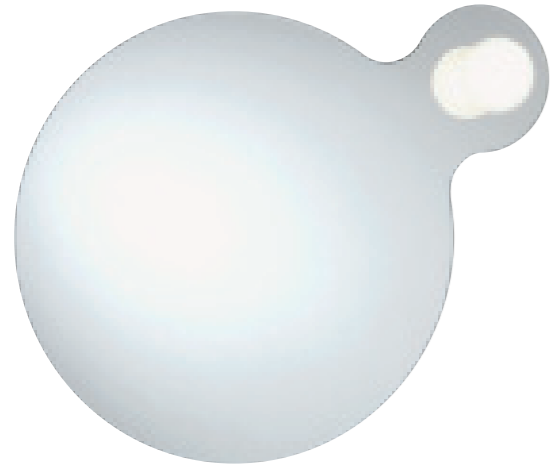

797 mod. dep. 402016000082680

Specchio sagomato filo lucido con illuminazione
 Cut mirror with shine edge with light
 Miroir coupé bord brillant avec la lumière
 Geformter Spiegel mit glänzendem Rand und Beleuchtung
 Декоративное зеркало с подсветкой
 cm 60 L x 90 H
 CE: V 220 V 12V IP 44 G9 40 W



1040 OMNIA

Specchio con molatura a bastone
 Cut mirror with grind
 Miroir avec meulage
 Spiegel mit Rundschliff
 Овальное зеркало
 cm 105 x 80

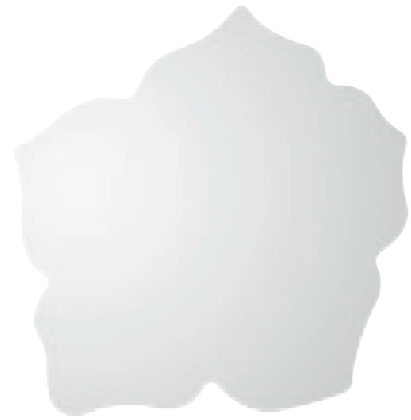

1001 PEONIA [DESIGN MASSIMILIANO SETTIMELLI] mod. dep. 402016000082680

Specchio sagomato filo lucido
 Cut mirror with shine edge
 Miroir coupé avec bord brillant
 Geformter Spiegel umkehrbar mit Rand
 Овальное зеркало
 cm 80 x 86

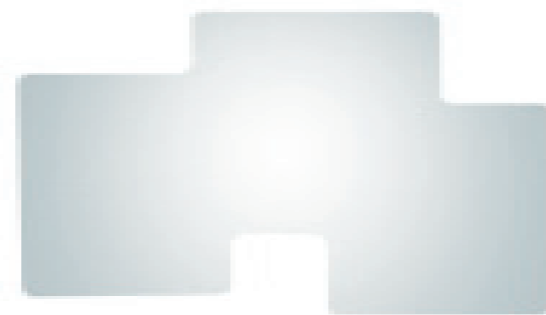

999 TETRIS [DESIGN MASSIMILIANO SETTIMELLI] mod. dep. 402016000082680

Specchio sagomato filo lucido
 Cut mirror with shine edge
 Miroir coupé avec bord brillant
 Geformter Spiegel umkehrbar mit Rand
 Овальное зеркало
 cm 60 L x 80 H

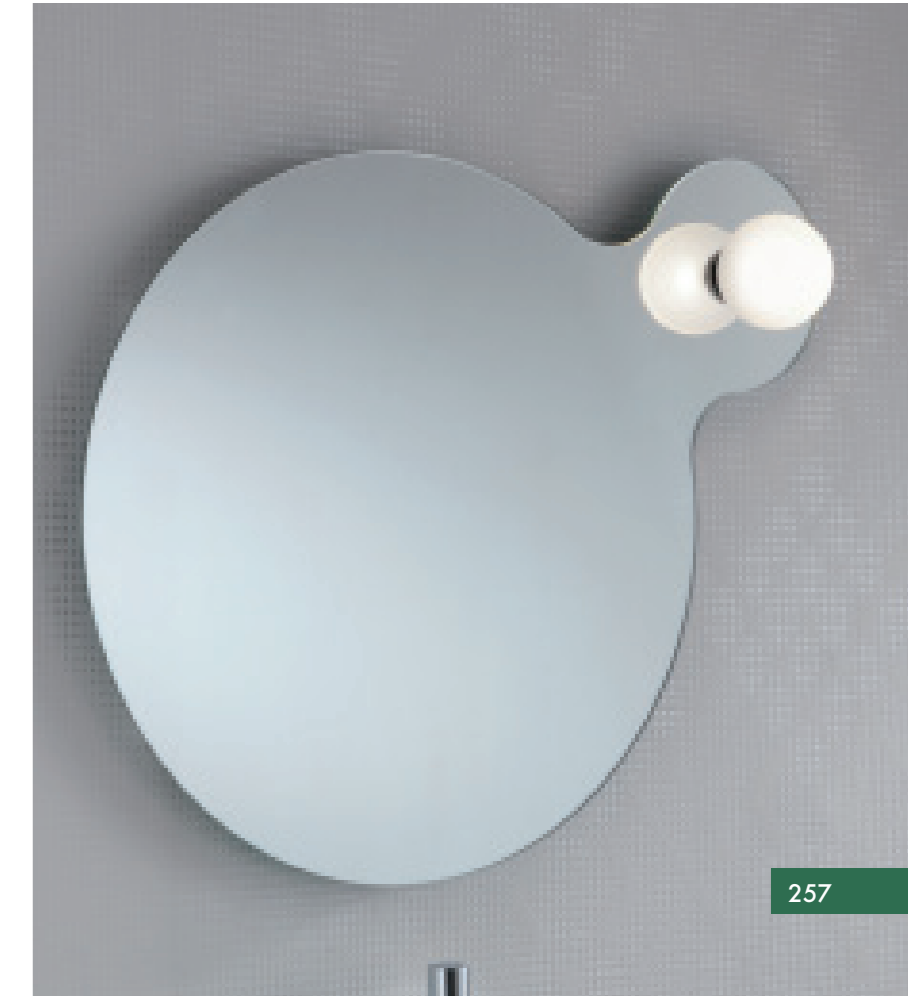



R 01.03

Specchio sagomato molato
 Cut mirror with grind
 Miroir coupé avec meulage
 Geformter Spiegel mit Schliff
 Зеркало скошенные
 cm 60 L x 80 H



LV01

Specchio sagomato
 Cut mirror
 Miroir coupé
 Geformter Spiegel
 Декоративное зеркало
 cm 50 L x 90 H

CE: LED - 13 W - V220 - IP21



- filo lucido/shine edge/bord brillant/glänzender Rand / провод полированный
- con led perimetrale /with diffused led light / avec led lumiere diffused / mit led Hinterleuchtung / LED периметру с

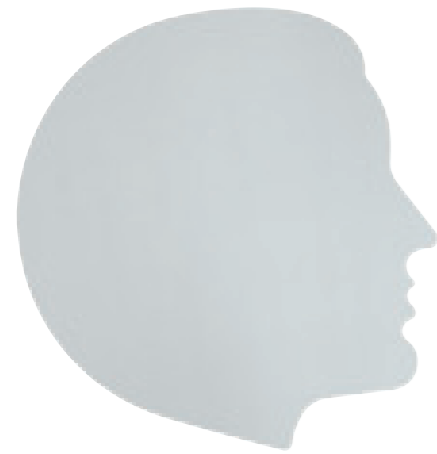

895 LUI [DESIGN MASSIMILIANO SETTIMELLI] mod. dep. 402016000082680

LUI specchio sagomato filo lucido
 LUI cut mirror with shine edge
 LUI miroir coupé avec bord brillant
 LUI geformter Spiegel mit glänzendem Rand
 Мужская форма зеркала
 cm 76 L x 65 H



896 LEI [DESIGN MASSIMILIANO SETTIMELLI] mod. dep. 402016000082680

LEI specchio sagomato filo lucido
 LEI cut mirror with shine edge
 LEI miroir coupé avec bord brillant
 LEI geformter Spiegel mit glänzendem Rand
 Женская форма зеркала
 cm 76 L x 65 H





1041

Specchio con LED perimetrale
 Mirror with diffused led light
 Miroir avec led lumiere diffusée
 Spiegel mit LED Hinterleuchtung
 Прямоугольное зеркало с внутренней подсветкой и алюминиевым
 обрамлением
 cm 80 L x 100 H
 CE: Led 13 W – V 220 - IP21



1066

Specchio Retroilluminato LED, con fasce satinato
 Mirror with LED light
 Miroir avec LED lumiere
 Spiegel mit LED Hinterleuchtung
 Зеркало с подсветкой
 cm 60 L x 80 H • Reversibile
 CE: Led 7,5 W – V 220 - IP21

• 08



1118

Specchio con LED perimetrale
 Mirror with diffused led light
 Miroir avec led lumiere diffusée
 Spiegel mit LED Hinterleuchtung
 Прямоугольное зеркало с внутренней подсветкой и алюминиевым
 обрамлением
 cm Ø 70
 CE: Led 13 W – V 220 - IP21



1159

Specchio con LED perimetrale
 Mirror with diffused led light
 Miroir avec led lumiere diffusée
 Spiegel mit LED Hinterleuchtung
 Прямоугольное зеркало с внутренней подсветкой и алюминиевым
 обрамлением
 cm 70 x 90 • Reversibile
 CE LED 13 W V 220 IP44

• 08





842  Pag. 272

Specchio Retroilluminato LED, con cornice cromata
 Mirror with LED light, chrome aluminium frame
 Miroir avec LED lumière, cadre en aluminium Chromé
 Spiegel mit LED Hinterleuchtung und Halterung aus Chrom
 Зеркало с подсветкой, с хромированной алюминиевой раме
 cm 60 L x 90 H



CE: LED - 9W - V220 - IP21

•08



949  Pag. 272

Specchio retroilluminato LED, cornice cromata, luce perimetrale diffusa
 Mirror with diffused led light, chrome aluminium frame
 Miroir avec led lumière diffuse, cadre en aluminium Chromé
 Spiegel mit LED-Beleuchtung (diffus) und Halterung aus Chrom
 Зеркало с подсветкой, с хромированной алюминиевой раме, рассеянный свет
 cm 60 L x 90 H



CE: LED - 9+5 W - V220 - IP21

•08



843  Pag. 272

Specchio Retroilluminato LED, con cornice cromata
 Mirror with LED light, chrome aluminium frame
 Miroir avec LED lumière, cadre en aluminium chromé
 Spiegel mit LED Hinterleuchtung und Halterung aus Chrom
 Зеркало с подсветкой, с хромированной алюминиевой раме
 cm 90 L x 70 H



CE: LED - 10,5W - V220 - IP21

•08



948  Pag. 272

Specchio retroilluminato LED, cornice cromata, luce diffusa
 Mirror with diffused led light, chrome aluminium frame
 Miroir avec led lumière diffuse, cadre en aluminium Chromé
 Spiegel mit LED-Beleuchtung (diffus) und Halterung aus Chrom
 Зеркало с подсветкой, с хромированной алюминиевой раме, рассеянный свет
 cm 90 L x 70 H



CE: LED - 13+8,6 W - V220 - IP21

•08





1115  Pag. 272

Specchio Retroilluminato LED, con cornice cromata
 Mirror with LED light, chrome aluminium frame
 Miroir avec LED lumière, cadre en aluminium chromé
 Spiegel mit LED Hinterleuchtung und Halterung aus Chrom
 Зеркало с подсветкой, с хромированной алюминиевой раме



cm 90 L x 70 H
 CE: LED - 19,2W - V220 - IP21

•08

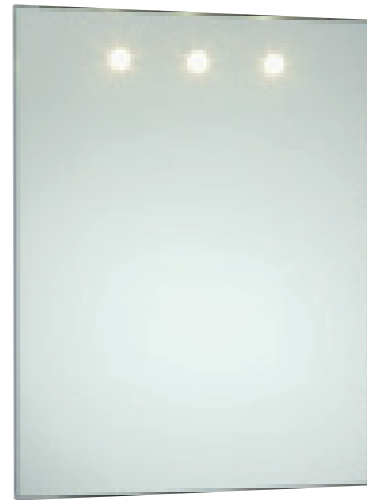

1116

Specchio Retroilluminato con spot LED, con cornice cromata
 Mirror with LED light, chrome aluminium frame
 Miroir avec LED lumière, cadre en aluminium chromé
 Spiegel mit LED Hinterleuchtung und Halterung aus Chrom
 Зеркало с подсветкой, с хромированной алюминиевой раме



cm 70 L x 90 H
 CE: LED - 3x3,5W - V220 - IP21

•08



1055  Pag. 272

Specchio Retroilluminato LED, con cornice cromata
 Mirror with LED light, chrome aluminium frame
 Miroir avec LED lumière, cadre en aluminium Chromé
 Spiegel mit LED Hinterleuchtung und Halterung aus Chrom
 Зеркало с подсветкой, с хромированной алюминиевой раме



cm 60 L x 90 H
 CE: Led 7,5 W - V 220 - IP21

•08



1139

Specchio Retroilluminato LED, con cornice cromata
 Mirror with LED light, chrome aluminium frame
 Miroir avec LED lumière, cadre en aluminium Chromé
 Spiegel mit LED Hinterleuchtung und Halterung aus Chrom
 Зеркало с подсветкой, с хромированной алюминиевой раме



cm 60 L x 80 H
 CE: Led 36 W - V 220 - IP21

•08





1100

Specchio retroilluminato e luce LED con impianto bluetooth musica e vivavoce, comandi sabbiati

Mirror with LED light, chrome aluminium frame, music and speaker phone, sandblaster controls

Miroir avec LED lumière, cadre en aluminium chromé haut-parleur, commandes sablées

Spiegel mit LED-Hinterleuchtung und Halterung aus Chrom Freisprecheinrichtung, sandgestrahlte Bedienelemente

зеркало с LED подсветкой, с системой bluetooth, музыкой и усилителем звука

cm 65 L x 90 H

CE: LED - 10,5W - V220 - IP21



• 08





798

Specchio tondo con molatura a bastone

Cut round mirror with grind
Miroir coupé avec meulage
Runder Spiegel mit Rundschliff
 Круглое зеркало

cm Ø 70



968

Specchio molato e inciso

Bavelled mirror and engraved
Miroir avec meulage et gravée
Spiegel mit geätzten Rundschliff
 зеркало скошенные травленое

cm 70 L x 90 H



906

Specchio rettangolare con molatura a bastone

Cut rectangular mirror with grind
Miroir rectangulaire avec meulage
Rechteckiger Spiegel mit Rundschliff
 Овальное зеркало

cm 65 L x 90 H



563

Specchio sagomato con molatura a bastone

Cut mirror with grinding
Miroir coupé avec meulage
Geformter Spiegel mit Rundschliff
 Овальное зеркало

cm 70 L x 90 H





EL 01 ELITE

Specchio molato orientabile
Adjustable and grind mirror
Miroir réglable avec meulage
Justierbare Spiegel mit Rundschiiff
зеркало скошенные регулируемый
cm 63 L x Ø 50 x 10 P



- 08
- 16 - 25 - 36



PR 01 PRISMA

Specchio molato orientabile
Adjustable and grind mirror
Miroir réglable avec meulage
Justierbare Spiegel mit Rundschiiff
зеркало скошенные регулируемый
cm 63 L x 70 H x 10 P



- 08
- 16 - 25 - 36



G 698 GIUNONE

Specchio attrezzato come foto
Equipped mirror same photo
Miroir équipé comme photo
Spiegel mit Ablage und Beleuchtung
Зеркало с латунной рамой с полкой
cm 70 L x 95 H



- 08
- 16 - 25 - 36

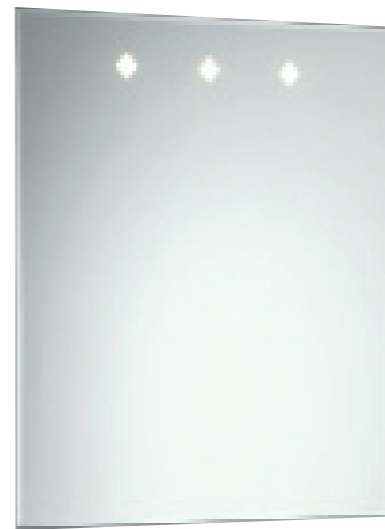

1132 DIVA

Specchio molato retroilluminato con spot LED
Mirror with LED light
Miroir avec LED lumière
Spiegel mit LED Hinterleuchtung und Halterung
Зеркало с подсветкой, с хромированной алюминиевой раме
cm 70 L x 90 H



CE: LED - 3x3,5W - V220 - IP21

- 08



SPECCHI SU MISURA

MIRROR ON MEASURE / MIROIRS SUR MEASURE / MIT GLÄNZENDEM RAND / зеркала под заказ

- **1 VETRO a filo lucido (indicare L x H): € 195,00 (per mq)**
GLASS with shine edge (indicate L x H): € 195,00 (for mq)
VERRE bord brillant (indiquer L x H): € 195,00 (pour mq)
GLAS mit glänzendem rand (zeigen L x H): € 195,00 (pro mq)
 стекло с полированными краями (государственный ШхВ): € 195,00 (за кв.м.)
- **2 VETRO molato cm 1 (indicare L x H): € 260,00 (per mq)**
GLASS Grind cm 1 (indicate L x H): € 260,00 (for mq)
VERRE Meulage cm 1 (indiquer L x H): € 260,00 (pour mq)
GLAS Facettenschiliff cm 1 (zeigen L x H): € 260,00 (pro mq)
 стекло земля 1 см (Ш x В): указывающие € 260,00 (за кв.м.)
- **3 VETRO tondo filo lucido € 195,00 per diametro**
GLASS round with shine edge: € 195,00 (for DIAMETR)
VERRE bord brillant (indiquer L x H): € 195,00 (pour diamètre)
GLAS mit glänzendem Rand (zeigen L x H): € 195,00 (pro durchmesser)
 стекла круглой формы € 195,00 за диаметр

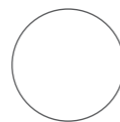

FISSAGGI PER SPECCHI NON RETROILLUMINATI / FIXING FOR MIRROR WITHOUT LED BACKLIGHTED / CHÂSSIS POUR MIROIRS SANS RÉTRO-ÉCLAIRAGE / Rahmen für Spiegel ohne LED-integrierte / Крепеж для зеркал без светодиодной подсветки

	ESEMPIO EXAMPLE / EXEMPLE BEISPIEL / Пример		
<ul style="list-style-type: none"> • A) Piastra per specchi, mm 6 Mirror slab mm 6 Plaque mm 6 pour mirror Platte mm 6 für Spiegel Пластинчатые 6 мм для зеркал 	1 + A	[maggiorazione] supplement supplément Aufpreis дополнение	498
<ul style="list-style-type: none"> • B) Solo telaio inox lucido, mm 26 Only frame mm 26 Seulement cadre mm 26 Rahmen Edelstahl poliert Только 26 мм полированная рама из нержавеющей стали 	1 + B	[maggiorazione] supplement supplément Aufpreis дополнение	583
<ul style="list-style-type: none"> • D) Cornice cromata, mm 25 Chromed frame mm 25 Cadre Chrome mm 25 Rahmen Verchromt mm 25 Хромовый остов 25 мм 	1 + D	[maggiorazione] supplement supplément Aufpreis дополнение	678
<ul style="list-style-type: none"> • E) Per specchi con lato superiore cm 150 L For mirrors biggest than cm 150 L Pour miroir avec une longueur supérieure à cm 150 Spiegel ab 150 cm Länge для зеркала свыше 150 L доплата 	1 + B + E	[maggiorazione] supplement supplément Aufpreis дополнение	

RETROILLUMINATI LED 4000K / LED BACKLIGHTED 4000K / RÉTRO-ÉCLAIRAGE LED 4000K / LED-integrierte 4000K / со светодиодной подсветкой 4000K

	ESEMPIO EXAMPLE / EXEMPLE BEISPIEL / Пример		
<ul style="list-style-type: none"> • F) Retroilluminati cornice cromata, sabbiatura cm 50 max, led 10 W, interruttore Backlit mirrors, frame, frosted glass cm 50 max, led 10 W, with switch Miroirs avec la lumierer, cadre, en verre dépoli cm 50 max, led 10 W, interrupteur Spiegel mit integrierter LED-Leuchte, Rahmen verchromt Milchglas cm 50 max, led 10 W, Schalter Подсветка Chrome Frame, взрывные 50 см макс, 10 Вт светодиод, выключатель 	1 + F	[maggiorazione] supplement supplément Aufpreis дополнение	842
<ul style="list-style-type: none"> • G) Retroilluminati cornice cromata, sabbiatura cm 70 max, led 14 W, interruttore Backlit mirrors, frame, frosted glass cm 70 max, led 14 W, with switch Miroirs avec la lumierer, cadre, en verre dépoli cm 70 max, led 14 W, interrupteur Spiegel mit integrierter LED-Leuchte, Rahmen verchromt, Milchglas cm 70 max, led 14 W, Schalter Подсветка Chrome Frame, взрывные макс 70 см, Ш 14 LED, переключатель 	1 + G	[maggiorazione] supplement supplément Aufpreis дополнение	842
<ul style="list-style-type: none"> • H) Retroilluminati cornice cromata, sabbiatura cm 100 max, led 19,9 W, interruttore Backlit mirrors, frame, frosted glass cm 100 max, led 19,9 W, with switch Miroirs avec la lumierer, cadre, en verre dépoli cm 100 max, led 19,9 W, interrupteur Spiegel mit integrierter LED-Leuchte, Rahmen verchromt Milchglas cm 100 max, led 19,9 W, Schalter Подсветка Chrome Frame, взрывные макс 100 см, Ш 19,9 LED, переключатель 	1 + H	[maggiorazione] supplement supplément Aufpreis дополнение	842
<ul style="list-style-type: none"> • i) Retroilluminati cornice cromata, sabbiatura superiore a cm 100, led 19,9 W, interruttore Backlit mirrors, frame, frosted glass cm 100 max, led 19,9 W, with switch Miroirs avec la lumierer, cadre, en verre dépoli cm 100 max, led 19,9 W, interrupteur Spiegel mit integrierter LED-Leuchte, Rahmen verchromt Milchglas cm 100 max, led 19,9 W, Schalter Подсветка Chrome Frame, взрывные более 100 см, ширина 19,9 LED, переключатель 	1 + i	[maggiorazione] supplement supplément Aufpreis дополнение	842
<ul style="list-style-type: none"> • J) Retroilluminati cornice cromata, doppia sabbiatura verticale cm 50 max, led 19,9 W, interruttore Backlight mirrors, frame, double vertical frosted glass cm 50 max, led 19,9 W, with switch Miroirs avec la lumierer, cadre, en verre dépoli vertical cm 50 max, led 19,9 W, interrupteur Spiegel mit Hinterleuchtung, Halterung, Milchglas cm 50 max, led 19,9 W, Schalter Зеркало со встроенной LED подсветкой 19,9 Вт, с хромированной окантовкой, выключателем 	1 + J	[maggiorazione] supplement supplément Aufpreis дополнение	1115
<ul style="list-style-type: none"> • K) Retroilluminati cornice cromata, 3 spot led, 3,5 W c.d., interruttore Backlight mirrors, frame, 3 spot led, 3,5 W c.d., with switch Miroirs avec la lumierer, cadre, 3 spot led, 3,5 W, 3,5 W c.d., interrupteur Spiegel mit Hinterleuchtung, Halterung 3 spot led, 3,5 W, 3,5 W c.d, led 19,9 W, Schalter Зеркало с подсветкой сзади, 3 LED режима, с хромированной окантовкой, выключателем 	1 + K	[maggiorazione] supplement supplément Aufpreis дополнение	1116
<ul style="list-style-type: none"> • L) Retroilluminati cornice cromata, 6 punti POWER LED 8,4 W, interruttore Backlit mirrors, frame, 6 POINT POWER LED, led 7,5 W, with switch Miroirs avec la lumierer, cadre, poli cm 6 POINTS POWER LED 7.5w, interrupteur Spiegel mit Hinterleuchtung, Halterung, 6 Punkte Power LED, led 7,5 W, Schalter подсветкой, хромированная рама, 6 точек POWER LED 7,5 W, выключатель 	1 + L	[maggiorazione] supplement supplément Aufpreis дополнение	1055
<ul style="list-style-type: none"> • M) LED perimetrale, con canalina protetta montata a filo specchio (per mt) LED perimeter with frame protected, mounted mirror wire (for mt) Pèrimètre LED avec cadre de protection, fil de miroir monté (pour mt) LED seitlich, mit integrierter satiniertes abdeckung, amrand LED по периметру, с изоляционной защитой, установленной заподлицо зеркала 	1 + F + M	[maggiorazione] supplement supplément Aufpreis дополнение	948
<ul style="list-style-type: none"> • N) LED perimetrale, con canalina protetta montata 3 cm interno specchio (per mt) LED perimeter with frame protected mounted 3 cm interior mirror (for mt) Pèrimètre LED avec cadre de protection monté de 3 cm de intérieur de miroir (pour mt) LED seitlich, mit integrierter satiniertes abdeckung, amrand 3 cm rahmen-rudsprung LED по периметру, с изоляционной защитой, установленной 4 см внутри зеркала 	1 + F + N	[maggiorazione] supplement supplément Aufpreis дополнение	1159
<ul style="list-style-type: none"> • O) Impianto e telaio per specchi con sola luce perimetrale Plant and frame for mirrors with only perimeter light Plante et cadre de miroirs avec seulement la lumière de périmètre Halterung und Rahmen für Spiegel mit Umrandungsbeleuchtung Машины и рама зеркала с только легкой периметру 	1 + O + M	[maggiorazione] supplement supplément Aufpreis дополнение	1159

OPZIONI / OPTION / OPTIONS / OPTIONEN / ВАРИАНТЫ

• P) Interruttore a Sfiornamento per specchi

Touch switch for mirrors
 Interrupteur tactile pour miroirs
 Touch-Schalter für Spiegel
 Сенсорный выключатель для зеркала

[maggiorazione]
 supplément
 supplément
 Aufpreis
 дополнение



• Q) Resistenza antiappannamento per specchi

Anti-fog resistance for mirrors
 Résistance anti-buée pour les miroirs
 Anti-Beschlag für Spiegel
 функция антизапотевания

[maggiorazione]
 supplément
 supplément
 Aufpreis
 дополнение

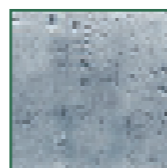

• R) Specchio ingranditore integrato sul vetro per specchi fino a L. 112 x H 64

Magnifying mirror integrated in the mirror until cm 112 L x 64 H
 Miroir grossissant intégré dans le miroir jusqu'à cm 112 L x 64 H
 Vergrößerungsspiegel in den Spiegel integriert bis zu cm 112 L x 64 H
 Увеличительное зеркало, встроенное на поверхность зеркала длиной до 112 x высотой до 64

[maggiorazione]
 supplément
 supplément
 Aufpreis
 дополнение



Misure superiori a L. 112 x H 64

Magnifying mirror integrated in the mirror up to cm 112 L x 64 H
 Miroir grossissant intégré dans le miroir plus élevé que cm 112 L x 64 H
 Vergrößerungsspiegel in den Spiegel integriert höher als cm 112 L x 64 H
 максимальные размеры длина 112 x высота 64

[maggiorazione]
 supplément
 supplément
 Aufpreis
 дополнение

• S) Specchio ingranditore RETROILLUMINATO integrato sul vetro per specchi fino a L. 112 x H 64

Magnifying mirror integrated in the mirror until cm 112 L x 64 H
 Miroir grossissant intégré dans le miroir jusqu'à cm 112 L x 64 H
 Vergrößerungsspiegel in den Spiegel integriert bis zu cm 112 L x 64 H
 Увеличительное зеркало с подсветкой, встроенное на поверхность зеркала длиной до 112 x высотой до 64

[maggiorazione]
 supplément
 supplément
 Aufpreis
 дополнение

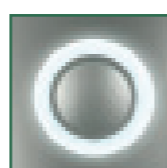

Misure superiori a L. 112 x H 64

Magnifying mirror integrated in the mirror up to cm 112 L x 64 H
 Miroir grossissant intégré dans le miroir plus élevé que cm 112 L x 64 H
 Vergrößerungsspiegel in den Spiegel integriert höher als cm 112 L x 64 H
 максимальные размеры длина 112 x высота 64

[maggiorazione]
 supplément
 supplément
 Aufpreis
 дополнение

• T) Impianto bluetooth vivavoce e luci con comandi sabbiati su vetro

bluetooth vivavoce plants and lights with sabbiated glass controls
 bluetooth et système contrôle de la lumière avec sablée commandes sur verre
 Halterung für Bluetooth-Freisprecheinrichtung und satinierter Bedienungseinheit
 система bluetooth и освещение с командами с зеркалом с подсветкой

[maggiorazione]
 supplément
 supplément
 Aufpreis
 дополнение

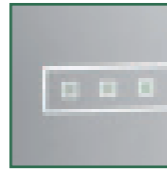

• U) Impianto bluetooth senza comandi con specchio retroilluminato

bluetooth plants without controls with back light mirror
 bluetooth système sans commandes avec des miroirs rétro-éclairés
 Bluetooth-Anlage ohne Bedienungseinheit
 система bluetooth без команд с зеркалом с подсветкой

[maggiorazione]
 supplément
 supplément
 Aufpreis
 дополнение



Impianto bluetooth senza comandi per specchio senza illuminazione (fornito con alimentatore)

bluetooth plants without controls with mirror without illumination (supplied with power supply)
 bluetooth système sans commandes avec miroir d'éclairage (fourni avec l'alimentation)
 Bluetooth-Anlage ohne Bedienungseinheit für Spiegel ohne Beleuchtung
 система bluetooth без команд для зеркал без подсветки (поставляется вместе с блоком питания)

[maggiorazione]
 supplément
 supplément
 Aufpreis
 дополнение

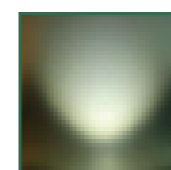

LED 4000 K

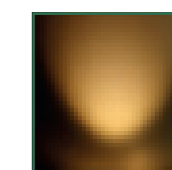

LED 2700 K

SU RICHIESTA
 on demand
 Sur demande
 Auf Anfrage
 По запросу

IMBALLI - Per spedizioni si provvederà al recupero in fattura di:

€ 5,00 netti a specchio per misure fino cm 150
 € 10,00 netti a specchio per misure superiori cm 150

PACKAGING - For shipments of mirrors we will debit:

€ 5,00 as extra packing contribution for mirror under cm 150.
 € 10,00 as extra packing contribution for mirror over cm 150.

EMBALLAGE - Dans les livraisons des miroirs nous allons debiter en facture:

€ 5,00 net sous titre de fret d'emballage special dessous cm 150.
 € 10,00 net sous titre de fret d'emballage special dessus cm 150.

AUFSCHLAG FÜR SPIEGEL - Sonderverpackungen:

€ 5 netto Sonderverpackungen unter 150 cm
 € 10 netto Sonderverpackungen über 150 cm

Упаковка - для перевозок мы добавляем в счет:

5 евро нетто для зеркал размером до 150 см
 10 евро нетто для зеркал размером более 150 см



1. Fascia LED destra con sfere Art.797 lato sinistro



2. Doppia fascia LED



3. 8 punti LED 3W 2700K



4. Fascia LED a disegno



5. Fascia LED perimetrale interna



6. Fascia LED con specchio ingranditore integrato

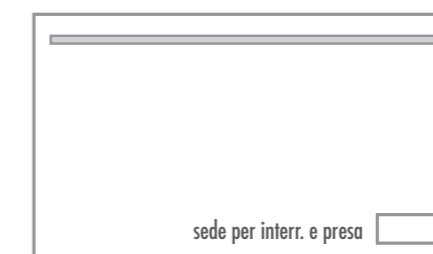

7. Fascia LED con sede per interruttore a parete



8. Fascia led con scasso per interruttore a parete

Lampi di luce in una galassia lontana

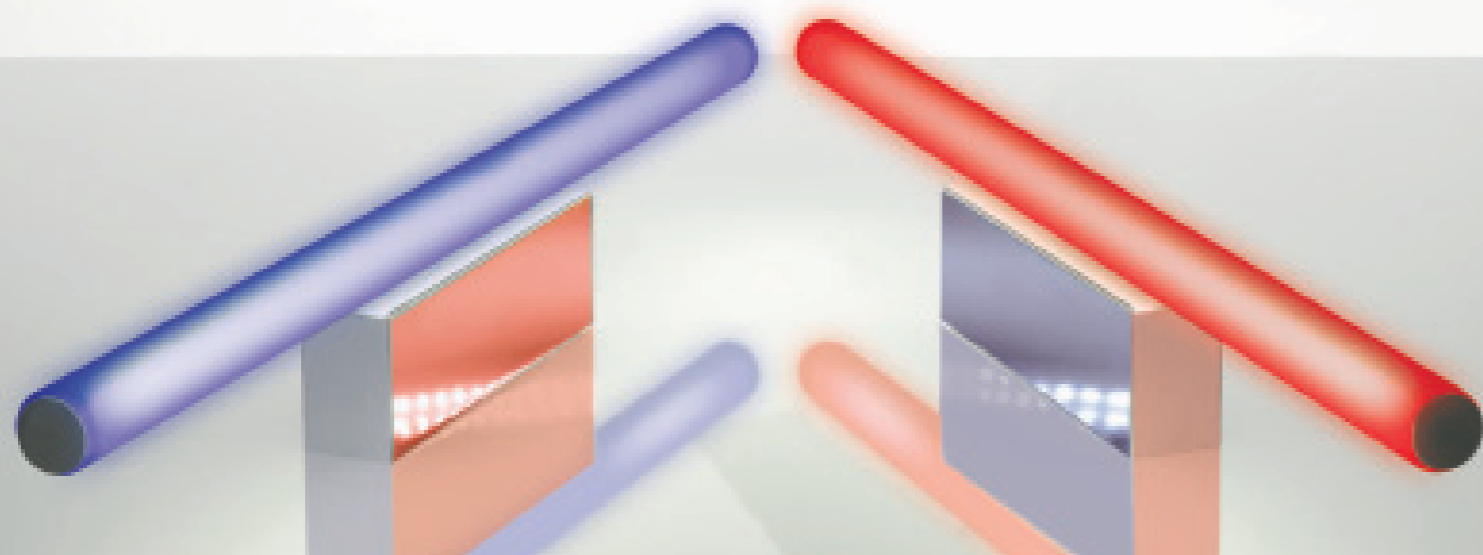

ILLUMINAZIONE

Designer: Stilhaus

Fuori misura: Sì

I prezzi delle illuminazioni a bassa tensione (12V)

comprendono il costo dei trasformatori.

RAEE: Iscr. Al Registro A.E.E. n. IT

311000008191,

i prezzi delle illuminazioni non comprendono il contributo

Designer: Stilhaus

Customized: Yes

The prices of the low-voltage halogen lights (12V)

include the cost of the transformers.

RAEE: Iscr. Register to A.E.E. n.

311000008191 IT,

prices do not include the contribution of the illuminations

Designer: Stilhaus

Personnalisé: Oui

Les prix des lampes halogènes basse tension (12V)

comprennent le coût des transformateurs.

RAEE: Iscr. Inscrivez-vous pour A.E.E. n.

311000008191 IT,

prix ne comprennent pas la contribution des illuminations

Designer: Stilhaus

Kundenwunsch: Ja

Die Preise für die Niedervolt-Halogenlampen (12 V)

sind die Kosten der Transformatoren.

RAEE: Iscr. Registrieren A.E.E. n.

311000008191 IT,

Preise ohne Leuchtmittel

Разработка дизайна: Stilhaus

Негабаритный: да

Цены на низковольтных галогенных ламп (12V)

включают в себя стоимость трансформаторов.

RAEE: ISCR. Зарегистрируйся,

чтобы A.E.E. n. 311000008191 IT,

Цены не включают вклад иллюминации

859

Lampadario
Chandelier
Lustre
Hängeleuchte
Люстра электрическая
cm Ø 14 L x 40/70 H
CE: V 220 IP20 60Wx1

• 08

865

Lampadario doppio
Chandelier
Lustre
Hängeleuchte
Люстра электрическая
cm 14 P x 35 L x 40/70 H
CE: V 220 IP20 60Wx2

• 08

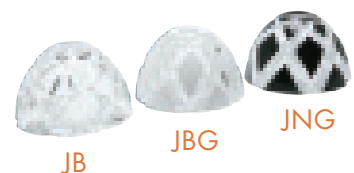

JB

JBG

JNG

> PAG. 299

860

Lampadario
Chandelier
Lustre
Hängeleuchte
Люстра с абажуром электрическая
cm Ø 17 L x 40/70 H
CE: V 220 IP20 60Wx1

• 08

861

Lampadario
Chandelier
Lustre
Hängeleuchte
Люстра квадратная электрическая
cm 10 L x 10 P x 40 H
CE: V 220 IP20 60Wx1

• 08

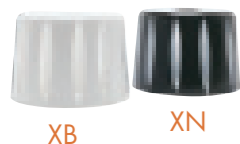

XB

XN

> PAG. 299



859



865



860



861

991 NE

Lampadario con paralume tessuto nero
Brass chandelier with black fabric lampshade
Lustre en laiton avec abat-jour tissu noir
Hängeleuchte mit Lampenschirm aus schwarzem Stoff
Латунная люстра с тремя лампами и абажуром (модель)

cm Ø 32 x 74 H

CE: V 220 IP20 60Wx1

• 08

• 16-25

991 BI

Lampadario con paralume tessuto bianco
Brass chandelier with white fabric lampshade
Lustre en laiton avec abat-jour tissu blanc
Hängeleuchte mit Lampenschirm aus weißem Stoff
Латунная люстра с тремя лампами и абажуром (модель)

cm Ø 32 x 74 H

CE: V 220 IP20 60Wx1

• 08

• 16-25



991 BI

i 24 IDRA

Lampadario in ottone paralume P
Brass chandelier lampshade p.
Lustre en laiton abajour p.
Hängeleuchte aus Messing Lampenglas p.
Латунная люстра с тремя лампами и абажуром (модель B)

cm Ø 50 x 68 H

CE: V 220 IP20 40Wx3

• 08

• 16-25



J

JB

JN

Z

P

B

> PAG. 298



i 24

630 LUX

Lampadario alogeno
Chandelier alogen
Lustre halogène
Hängeleuchte Halogenlampe
Люстра с галогеновой лампой
cm 25 L x 40 H

CE: V 220 IP 20 A20 R7S 100Wx1

- 08

EL 17 ELITE

Plafoniera in vetro satinato
Ceiling lamp
Plafonnier
Deckenleuchte

Светильник матовое стекло

cm Ø 40

CE: V 220 40Wx2

- 08

- 16 - 25 - 26

692

Plafoniera vetro sabbiato

Ceiling lamp

Plafonnier

Deckenleuchte

Люстра в латуневым обрамлении

cm Ø 34 x 14 H

CE: V 220 IP20 40Wx2

- 08

- 02 - 03 - 04

- 16 - 25 - 26 - 36

N 17 NEMI

Plafoniera vetro sabbiato

Ceiling lamp

Plafonnier

Deckenleuchte

Люстра в латуневым обрамлении

cm Ø 40 x 14 H

CE: V 220 40Wx2

vetro bianco / white glass / verre blanche / weiß glas

- N17 • 08

- N17 • 16 - 25 - 26 - 36

vetro rosa-verde / pink-green glass / verre rose-vert / rosa-grün glas

- N17 • 08

- N17 • 16 - 25 - 26 - 36



630



EL17



692



N 17



507



1003



1002

507

Plafoniera alogena
Ceiling lamp alogen
Plafonnier halogène
Deckenleuchte Halogenlampen

Люстра с 4 лампами регулируемые

cm Ø 20

CE: V 220/12v IP 20 G4 20Wx4

- 08

1002 LED

Plafoniera
Ceiling lamp
Plafonnier
Deckenleuchte

Светильник матовое стекло

cm Ø 30 x 4 H

CE: V 220 LED 15W 3000K

- 08

1003 LED

Plafoniera
Ceiling lamp
Plafonnier
Deckenleuchte

Светильник матовое стекло

cm 30 L x 30 P x 4 H

CE: V 220 LED 15W 3000K

- 08

1134

Applique LED a parete
 Wall mounted LED applique
 Applique à mur à LED
 LED Wandleuchte
 Настенные светильники светодиодный
 cm 30 L x 10 P x 8 H
 CE: V220 IP44 LED 4,8W/12V 4000K

• 08



LED

1134

1135

Applique LED a parete
 Wall mounted LED applique
 Applique à mur à LED
 LED Wandleuchte
 Настенные светильники светодиодный
 cm 56 L x 15 P x 8 H
 CE: V220 IP44 LED 7,9 W/12V 4000K

• 08



LED

1135

1104

Applique LED a parete
 Wall mounted LED applique
 Applique à mur à LED
 LED Wandleuchte
 Настенные светильники светодиодный
 cm 34,5 L x 9 P x 8 H
 CE: V220 IP20 LED 9,6W/12V 4000K

• 08

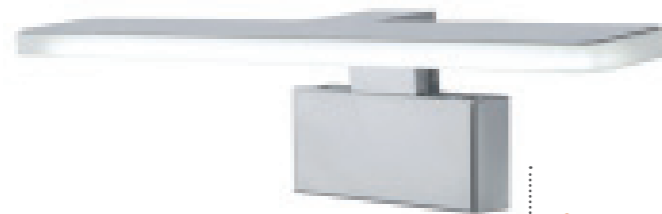

1104

1105

Applique LED a parete
 Wall mounted LED applique
 Applique à mur à LED
 LED Wandleuchte
 Настенные светильники светодиодный
 cm 55 L x 9 P x 8 H
 CE: V220 IP20 LED 12,5W/12V 4000K

• 08



1105



1110



1061

992

Applique LED a parete
 Wall mounted LED applique
 Applique à mur à LED
 LED Wandleuchte
 Настенные светильники светодиодный
 cm 50 L x 4 P x 10 H
 CE: V220 IP23 LED 8W/12V 4000K

• 08
 • 16 - 25

1110

Applique a parete con lampada alogena
 Wall mounted applique with alogen lamp
 Applique à mur avec lampe halogène
 Wandleuchte mit Halogenlampe
 Настенные светильники с галогеновой лампой
 cm 7,5 L x 10,5 P x 29 H
 CE: V220 IP44 G9 3W 3000K

• 08

1061

Applique LED a parete
 Wall mounted LED applique
 Applique à mur à LED
 LED Wandleuchte
 Настенные светильники светодиодный
 cm 55 L x 4 P x 5,5 H
 CE: V220 IP23 LED 9,6W/12V 4000K

• 08



992

1103

Applique a parete
 Wall mounted applique
 Applique à mur
 Wandleuchte
 Верхний светильник для зеркала с фиксацией
 cm 8 L x 9 P x 8 H
 CE: V 220 IP44 G9 4,8W 4000K

• 08

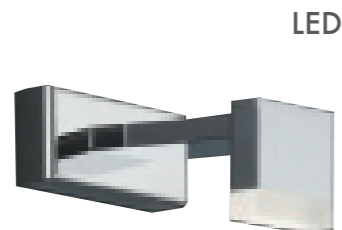

LED

1103

1161

Applique LED a parete
 Wall mounted LED applique
 Applique à mur à LED
 LED Wandleuchte
 Настенные светильники светодиодный
 cm 28 L x 17 P x 7 H
 CE 220 — IP 23 LED 4 W 12 V 3000 K

• 08



LED

1161

973

Applique a parete alogena
 Wall mounted applique
 Applique à mur
 Wandleuchte
 Верхний светильник для зеркала с фиксацией
 cm 28 L x 14 P x 12 H
 CE: V 220 IP44 G9 33Wx2

• 08



973

604 SQUARE

Applique a parete alogena
 Wall mounted applique
 Applique à mur
 Wandleuchte
 Верхний светильник для зеркала
 cm 20 L x 11 P x 4 H
 CE: V 220 IP20 R7s 100Wx1

• 08



604

774 MOON LED

Applique a parete
 Wall mounted applique
 Applique à mur
 Wandleuchte
 Верхний светильник для зеркала с фиксацией
 cm 10 L x 15 P x 15 H
 CE: V 220/12v IP44 G9 3W 3000K

• 08

1108

Applique LED a parete
 Wall mounted LED applique
 Applique à mur à LED
 LED Wandleuchte
 Настенные светильники светодиодный
 cm 30 L x 12 P x 8 H
 CE: V220 IP23 LED 6,5W/12V 4000K

• 08

913 NUVOLO

Applique a parete
 Wall mounted applique
 Applique à mur
 Wandleuchte
 Настенные светильники
 cm 25 L x 8 P x 20 H
 CE: V 220 IP20 G9 35Wx2

• 08



1108



774



913.08

470 LULÙ

Applique a parete paralume M
 Wall mounted applique, lampshade M
 Applique à mur, abat-jour M
 Wandleuchte Lampenglas, Lampenglass M
 Настенный металлический светильник
 регулируемый
 cm 22 L x 12 P
 CE: V 220 IP44 40Wx1

• 08



470



> PAG. 299

B 03

Applique a parete paralume M
 Wall mounted applique, lampshade M
 Applique à mur, abat-jour M
 Wandleuchte Lampenglas, Lampenglass M
 Настенный светильник с абажуром
 регулируемый
 cm 10 L x 10 P x 20 H
 CE: V 220 IP44 60Wx1

• 08



B 03

504

Applique alogena
 Applique alogen
 Applique halogène
 Wandleuchte Halogenlampen
 Настенный светильник с 3 регулируемые лампы
 cm Ø 10
 CE: V 220/12v IP20 G4 20Wx3

• 08



504



> PAG. 299

739 LOLITA

Applique a parete paralume H
 Wall mounted applique lampshade H
 Applique à mur abat-jour H
 Wandleuchte Lampenglas H
 Верхний светильник для зеркала H
 cm 9 L x 19 P x 18 H
 CE: V 220 IP44 40Wx1

• 08



739

915 ne

Applique a parete
 Wall mounted applique
 Applique à mur
 Wandleuchte
 Настенные светильники
 cm 15 L x 15 P x 24 H
 CE: V 220 IP44 40Wx1

• 08

• 16-25



915 ne

915 bi

Applique a parete
 Wall mounted applique
 Applique à mur
 Wandleuchte
 Настенные светильники
 cm 15 L x 15 P x 24 H
 CE: V 220 IP44 40Wx1

• 08

• 16-25



915 bi

849

Applique a parete paralume XB
 Wall mounted applique lampshade XB
 Applique à mur abat-jour XB
 Wandleuchte Lampenglas XB
 Верхний светильник для зеркала XB
 cm 11 L x 14 P x 23 H
 CE: V 220 IP44 60Wx1

• 08

• 16-25



849

848

Applique a parete paralume JB
 Wall mounted applique lampshade JB
 Applique à mur abat-jour JB
 Wandleuchte Lampenglas JB
 Верхний светильник для зеркала JB
 cm 11 L x 14 P x 23 H
 CE: V 220 IP244 40Wx1

• 08

• 16-25



848



> PAG. 299

1103 SP LED

Applique per specchio a led
 Led mirror lamp
 Lampe a Led pour miroir
 LED Leuchte für Spiegel
 Светодиодный настенный

светильник для зеркала
 cm 11 L x 7,5 P x 7 H
 CE: V 220 IP 20 9,6W 4000K

• 08



1103 SP

1106 SP ABS LED

Applique per specchio LED
 Applique for mirror LED
 Applique pour miroir LED
 Leuchte für Spiegel LED

Верхний светильник для зеркала
 cm 28 L x 10 P x 8 H
 CE: V 220 IP44 6,5W 4000K

• 08



1106 SP

1107 SP ABS LED

Applique per specchio LED
 Applique for mirror LED
 Applique pour miroir LED
 Leuchte für Spiegel LED

Верхний светильник для зеркала
 cm 13 L x 17 P x 10 H
 CE: V 220 IP44 6,6W 4000K

• 08



1107 SP

1108 SP LED

Applique per specchio a led
 Led mirror lamp
 Lampe a Led pour miroir
 LED Leuchte für Spiegel
 Светодиодный настенный

светильник для зеркала
 cm 20 L x 4 P x 4 H
 CE: V 220 IP23 LED 6W a 12 Vdc 6000K

• 08

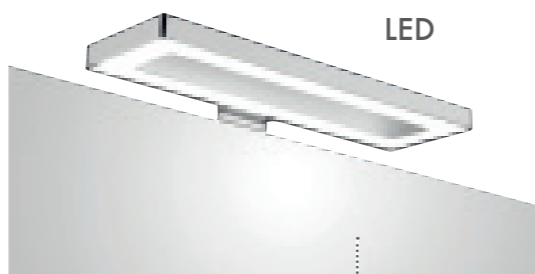

1108 SP

923 FLUID LED

Applique per specchio a led
 Led mirror lamp
 Lampe a Led pour miroir
 LED Leuchte für Spiegel
 Светодиодный настенный

светильник для зеркала
 cm 6 L x 10 P x 4 H
 CE: V 220 IP 44 6 W 4000K

• 08

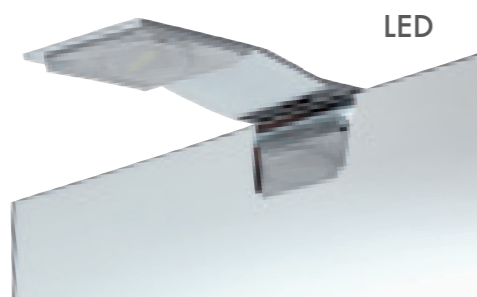

923

1060 calamita

Applique per specchio a led calamitata
 Led mirror lamp magnetized
 Lampe a Led pour miroir magnétisé
 LED Leuchte für Spiegel magnetisiert
 Светодиодный настенный

светильник для зеркала
 cm Ø 8 x 4 H
 CE: V 220 5 W 4000K

• 08



1110 SP

Applique per specchio a led
 Led mirror lamp
 Lampe a Led pour miroir
 LED Leuchte für Spiegel
 Светодиодный настенный

светильник для зеркала
 cm 7,5 L x 10,5 P x 29 H
 CE: V 220 IP 44 G9 3W 3000K

• 08



1134 SP

Applique per specchio a led
 Led mirror lamp
 Lampe a Led pour miroir
 LED Leuchte für Spiegel
 Светодиодный настенный

светильник для зеркала
 cm 30 L x 10 P x 3,5 H
 CE: V 220 IP 44 4,8W 4000K

• 08

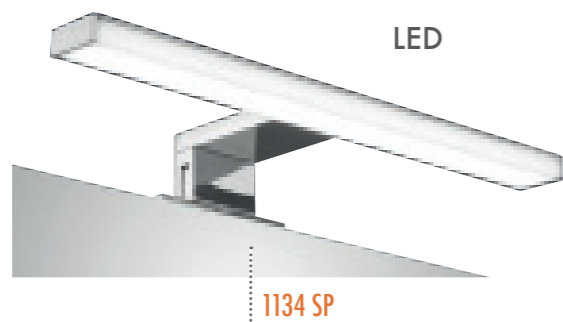

1134 SP

1135 SP

Applique per specchio a led
 Led mirror lamp
 Lampe a Led pour miroir
 LED Leuchte für Spiegel
 Светодиодный настенный

светильник для зеркала
 cm 56 L x 15 P x 4 H
 CE: V 220 IP44 8W a 12 Vdc 4000K

• 08

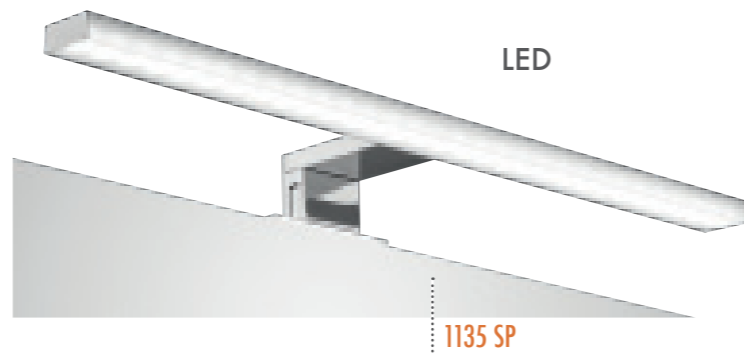

1135 SP

1136 SP

Applique per specchio a led
 Led mirror lamp
 Lampe a Led pour miroir
 LED Leuchte für Spiegel
 Светодиодный настенный

светильник для зеркала
 cm 56 L x 15 P x 4 H
 CE: V 220 IP44 8W a 12 Vdc 4000K

• 08



1136 SP

1104 SP LED

Applique per specchio a LED
 Applique for mirror LED
 Applique pour miroir LED
 Leuchte für Spiegel LED
 Верхний светильник

для зеркала LED
 cm 34,5 L x 9 P x 4 H
 CE: V 220 IP44 9W 4000K

• 08

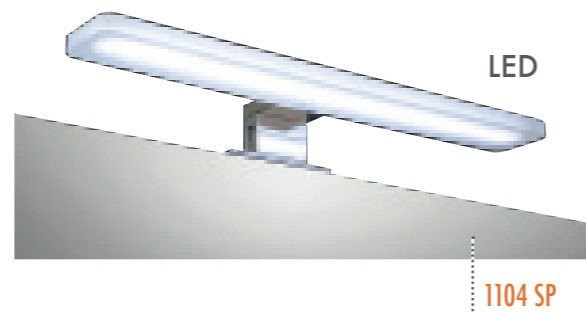

1104 SP

1105 SP LED

Applique per specchio LED
 Applique for mirror LED
 Applique pour miroir LED
 Leuchte Spiegel LED
 Верхний светильник

для зеркала LED
 cm 55,5 L x 9 P x 4 H
 CE: V 220 IP44 15W 4000K

• 08

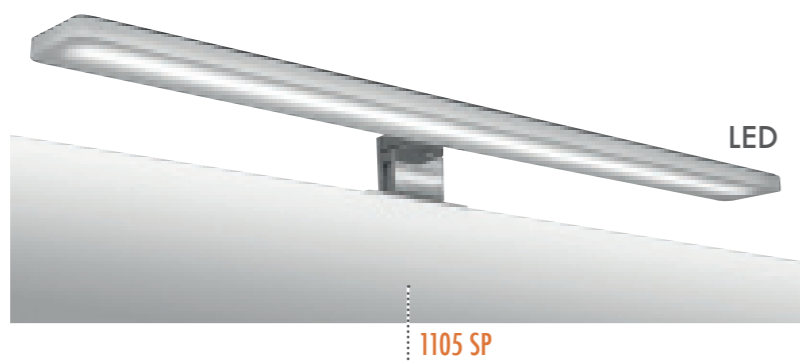

1105 SP

1063 canaletto LED

Applique per specchio a led
 Led mirror lamp
 Lampe a Led pour miroir
 LED Leuchte für Spiegel
 Светодиодный настенный

светильник для зеркала
 cm 40 L x 6 P x 4 H
 CE: V 220 IP21 8W 4000K

• 08

• 16-25



1101 SP LED

Applique per specchio a LED
 Led mirror lamp
 Lampe a Led pour miroir
 LED Leuchte für Spiegel
 Светодиодный настенный

светильник для зеркала
 cm 15 L x 13 P x 5 H
 CE: V 220 IP44 3,5W 4000K

• 08



1102 SP LED

Applique per specchio a LED
 Led mirror lamp
 Lampe a Led pour miroir
 LED Leuchte für Spiegel
 Светодиодный настенный

светильник для зеркала
 cm 30 L x 13 P x 5 H
 CE: V 220 IP44 6W 4000K

• 08



1141 SP LED

Applique per specchio orientabile
 Applique with fixing for mirror adjustable
 Applique pour miroir réglable
 Leuchte für Spiegel verstellbar
 Верхний светильник для зеркала



cm 6 L x 11 P x 3 H
 CE: V 220 IP44 3,5 W 4000K

• 08



1141 SP

1109 SP LED

Applique per specchio
 Applique for mirror
 Applique pour miroir
 Leuchte für Spiegel
 Верхний светильник для зеркала



cm 48 L x 8,5 P x 6 H
 CE: V 220 IP44 6,5 W 4000K

• 08

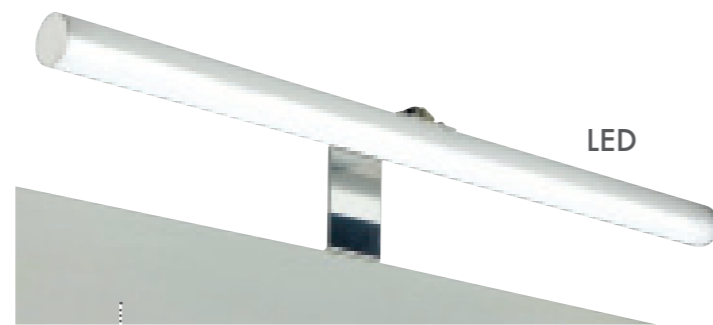

1109 SP

1142 SP LED

Applique per specchio
 Applique for mirror
 Applique pour miroir
 Leuchte für Spiegel
 Верхний светильник для зеркала



cm 57 L x 3 P x 3 H
 CE: V 220 IP44 7,9 W 4000K

• 08



1142 SP

1143 SP LED

Applique per specchio a led con interruttore touch
 Led mirror lamp with touch switch
 Applique pour miroir avec interrupteur tactile
 Leuchte für Spiegel mit Touch Schalter
 Верхний светильник для зеркала



cm 32 L x 7,5 P x 1,2 H
 CE: V 220 IP44 5,4 W 4000K

• 08

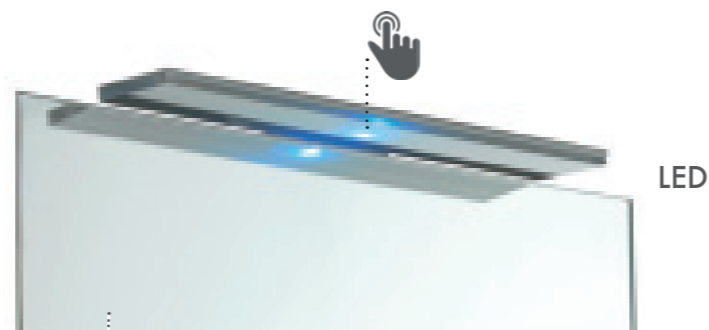

1143 SP



604 STA



B 03 SP



> PAG. 299



502



> PAG. 299

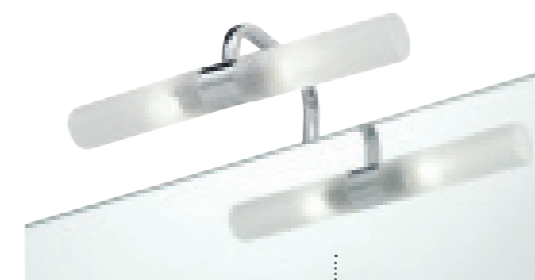

973 SP

604 STA

Applique per specchio alogena
 Applique for mirror
 Applique pour miroir
 Leuchte für Spiegel



Верхний светильник для зеркала
 cm 20 L x 4 P x 4 H
 CE: V 220 IP44 R7s 60Wx1

• 08

B 03 SP

Applique per specchio paralume M
 Applique for mirror, lampshade M
 Applique pour miroir, abat-jour M
 Leuchte für Spiegel, Lampenglass M
 Настенный светильник с абажуром регулируемый



cm 5 L x 10 P x 20 H
 CE: V 220 IP44 40Wx1

• 08

502

Applique per specchio con trasformatore
 Applique with fixing for mirror and transformer
 Applique pour miroir avec transformateur
 Leuchte für Spiegel mit Transformator
 Верхний бра с трансформатором



cm 6 L x 2,5 P
 CE: V 220/12V - IP20 - 20Wx2

• 08

973 sp

Applique per specchio alogena
 Applique for mirror
 Applique pour miroir
 Leuchte Spiegelleuchte
 Верхний светильник для зеркала



cm 28 L x 14 P x 8 H
 CE: V 220 IP44 G9 33Wx2

• 08

M 03

Applique a parete paralume B
 Wall mounted applique, lampshade B
 Applique à mur, abat-jour B
 Wandleuchte Lampenglas, Lampenglass B
 Настенный светильник для зеркал
 cm 10 L x 18 P x 23H
 CE: V 220 IP20 40Wx1

- 08
- 02
- 16 - 25 - 26 - 36

K 03.R

Applique a parete paralume Z
 Wall mounted applique, lampshade Z
 Applique à mur, abat-jour Z
 Wandleuchte Lampenglas, Lampenglass Z
 Настенный светильник с абажуром
 cm 10 L x 21 P x 18 H
 CE: V 220 IP20 40Wx1

- 08
- 02
- 16 - 25 - 26 - 36

K 03.S

Applique orientabile paralume Z
 Adjustable applique, lampshade Z
 Applique réglable, abat-jour Z
 Wandleuchte verstellbar, Lampenglass Z
 Регулируемый настенный светильник с абажуром
 cm 10 L x 22 P x 17 H
 CE: V 220 IP20 40Wx1

- 08
- 02
- 16 - 25 - 26 - 36

1064 LED

Applique orientabile a LED
 Adjustable applique LED
 Applique réglable LED
 Wandleuchte verstellbar LED
 Регулируемый настенный светильник с абажуром LED
 cm 37 L x 22 P x 17 H
 CE: V 220 IP20 G9 33Wx2

- 08
- 16 - 25 - 26



M 03



K 03.R



K 03.S



1064



> PAG. 298

958

Applique a parete
 Wall mounted applique
 Applique à mur
 Wandleuchte
 Настенные светильники
 cm 9 L x 15 P x 26 H x 22 B
 CE: V 220 IP20 40Wx1

- 08
- 16 - 25 - 26

957

Applique a parete
 Wall mounted applique
 Applique à mur
 Wandleuchte
 Настенные светильники
 cm 9 L x 15 P x 26 H x 22 B
 CE: V 220 IP20 40Wx1

- 08
- 16 - 25

1062 LED

Applique a parete
 Wall mounted applique
 Applique à mur
 Wandleuchte
 Настенные светильники
 cm 10 x 19 P x 20 H
 CE: V 220 IP44 G9 3W 3000K

- 08
- 16 - 25

1062 SL LED

Applique a parete
 Wall mounted applique
 Applique à mur
 Wandleuchte
 Настенные светильники
 cm 10 x 19 P x 20 H
 CE: V 220 IP44 G9 3W 3000K

- 08
- 16 - 25



958



957



1062



1062 SL

G 03 GIUNONE

Applique a parete paralume B
 Wall mounted applique, lampshade B
 Applique à mur, abat-jour B
 Wandleuchte Lampenglas, Lampenglass B
 Настенный светильник В абажуром
 cm 8 L x 16 P x 28 H
 CE: V 220 IP44 40Wx1

- 08
- 02 - 03 - 04
- 16 - 25 - 26 - 36

G 03.2 GIUNONE

Applique doppia, paralume B
 Applique with 2 lamps, lampshade B
 Applique avec 2 lampe, abat-jour B
 Wandleuchte doppelt, Lampenglass B
 Настенный 2 светильника В абажуром
 cm 10 L x 22 P x 28 H
 CE: V 220 IP44 40Wx2

- 08
- 02 - 03 - 04
- 16 - 25 - 26 - 36

EL 03 ELITE

Applique a parete, paralume P
 Wall mounted applique, lampshade P
 Applique à mur, abat-jour P
 Wandleuchte, Lampenglass P
 Настенные лампы с абажуром
 cm 14 L x 15 P x 15 H
 CE: V 220 IP44 40Wx1

- 08
- 02 - 03 - 04
- 16 - 25 - 26

EL 03.2 ELITE

Applique doppia, paralume P
 Applique with 2 lamps, lampshade P
 Applique avec 2 lampe, abat-jour P
 Wandleuchte doppelt, Lampenglass P
 Настенные 2 лампы с абажуром
 cm 36 L x 15 P x 16 H
 CE: V 220 IP44 40Wx2

- 08
- 02
- 16 - 25 - 26



G 03



G 03.2



EL 03



EL 03.2



B C D E I S > PAG. 298



F 03



i 824

F 03 FLORA

Applique a parete paralume B
 Wall mounted applique, lampshade B
 Applique à mur, abat-jour B
 Wandleuchte Lampenglas, Lampenglass B
 Настенный светильник с абажуром
 cm 10 L x 22 P x 21 H
 CE: V 220 IP44 40Wx1

- 32 - 43 - 51

i 824 IDRA LED

Applique a parete
 Wall mounted applique
 Applique à mur
 Wandleuchte
 Настенный светильник с абажуром
 cm 10 L x 24 P x 22 H
 CE: V 220 IP44 G9 3W 3000K

- 08
- 16 - 25

i 03 IDRA

Applique a parete paralume B
 Wall mounted applique, lampshade B
 Applique à mur, abat-jour B
 Wandleuchte Lampenglas, Lampenglass B
 Настенный светильник с абажуром
 cm 10 L x 24 P x 22 H
 CE: V 220 IP4440Wx1

- 08
- 16 - 25



i 03

MOD. B

Vetro sabbato
Sand glass
Verre sablé
Milchglas
Абажур (матовое стекло)
cm Ø 13 x 10 P

• B

**MOD. C**

Vetro sabbato con decoro a rilievo
Sand glass with decoration to relief
Verre sablé avec décoration à relief
Milchglas mit Dekor und Relief
Абажур (матовое стекло с рельефным украшением)
cm Ø 15 x 10 P

• C

- Con applique (maggiorazione)
With applique (supplement)
Avec applique (supplément)
Mit Wandleuchte (Zuschlag)

С аппликацией (за дополнительную плату)

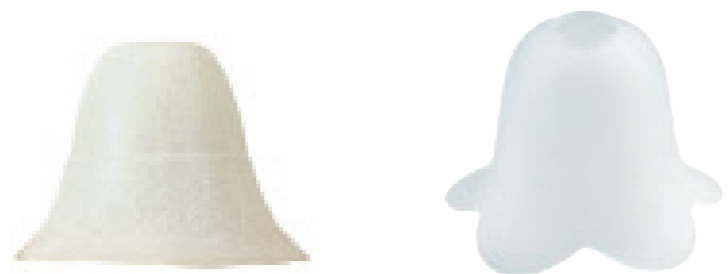
**MOD. D**

Vetro sabbato con decoro a rilievo rosa
Sand glass with pink decoration to relief
Verre sablé avec décoration rose à relief
Milchglas mit Dekor und Relief rosa
Абажур (матовое стекло с рельефным розовым украшением)
cm Ø 15 x 10 P

• D - Rosa / pink / rose / rosa

- Con applique (maggiorazione)
With applique (supplement)
Avec applique (supplément)
Mit Wandleuchte (Zuschlag)

С аппликацией (за дополнительную плату)

**MOD. E**

Vetro sabbato con decoro a rilievo verde
Sand glass with green decoration to relief
Verre sablé avec décoration vert à relief
Milchglas mit Dekor und grünem Relief
Абажур (матовое стекло с рельефным зелёным украшением)
cm Ø 15 x 10 P

• D - Verde / green / vert / grün

- Con applique (maggiorazione)
With applique (supplement)
Avec applique (supplément)
Mit Wandleuchte (Zuschlag)

С аппликацией (за дополнительную плату)

**MOD. S**

Ceramica decorata
Decorated ceramic
Céramique décorée
Bemalte Keramik
Абажур керамический
cm Ø 15 x 10 P

• Decorata / Decorated / Décorée / Bemalt / украшенный

- Con applique (maggiorazione)
With applique (supplement)
Avec applique (supplément)
Mit Wandleuchte (Zuschlag)

С аппликацией (за дополнительную плату)

MOD. Z

Vetro satinato
Satinated glass
Verre satiné
Satiniertes Glas
Абажур матовое стекло
cm Ø 13 x 10 P

• Z

MOD. I

Ceramica bianca
White ceramic
Céramique blanc
Weiße Keramik
белый керамический
cm Ø 15 x 10 P

• Bianco / white / blanc / weiß / белый

- Con applique (maggiorazione)
With applique (supplement)
Avec applique (supplément)
Mit Wandleuchte (Zuschlag)

С аппликацией (за дополнительную плату)

MOD. P

Vetro satinato con bordo trasparente
Satinated glass with transparent edge
Verre satiné avec bord transparent
Satiniertes Glas mit transparentem Rand
Абажур матовое стекло
cm Ø 14 x 11 P

• P

- Con applique (maggiorazione)
With applique (supplement)
Avec applique (supplément)
Mit Wandleuchte (Zuschlag)

С аппликацией (за дополнительную плату)

MOD. J - JB - JN

Vetro forte spessore per applique
Strong thickness glass for applique
Fort épaisseur pour applique
Glas für Wandleuchte, besondere Stärke
Стекло толщиной для абажура
cm Ø 11 x 8 H

• J - JB - JN

- Con applique (maggiorazione)
With applique (supplement)
Avec applique (supplément)
Mit Wandleuchte (Zuschlag)

С аппликацией (за дополнительную плату)

MOD. XB - XN

Vetro forte spessore per applique
Strong thickness glass for applique
Fort épaisseur pour applique
Glas für Wandleuchte, besondere Stärke
Стекло толщиной для абажура
cm 10 x 8 H

• XB - XN

- Con applique (maggiorazione)
With applique (supplement)
Avec applique (supplément)
Mit Wandleuchte (Zuschlag)

С аппликацией (за дополнительную плату)

MOD. Y

Vetro inciso per applique
Etched glass for applique
Verre gravé pour applique
Lampenglas geschliffen für Wandleuchte
Стекло гравированная люстра
cm 9 x 9 x 10 H

• Y

- Con applique (maggiorazione)
With applique (supplement)
Avec applique (supplément)
Mit Wandleuchte (Zuschlag)

С аппликацией (за дополнительную плату)

MOD. U

Vetro di Murano in diversi colori
Murano's glass in various colors
Verre de Murant en diversés couleurs
Muranglas in verschiedenen Farben
Мурано стекло различных цветов
cm Ø 3 x 4 H

• U

MOD. JG - JBG - JNG

Vetro forte spessore per lampadario
Strong thickness glass for chandelier
Fort épaisseur pour lustre
Glas für Hängeleuchte, besondere Stärke
Стекло толщиной для абажура
cm Ø 14,5 x 9 H

**MOD. XBG - XNG**

Vetro forte spessore per lampadario
Strong thickness glass for chandelier
Fort épaisseur pour lustre
Glas für Hängeleuchte, besondere Stärke
Стекло толщиной для абажура
cm Ø 17 x 8 H

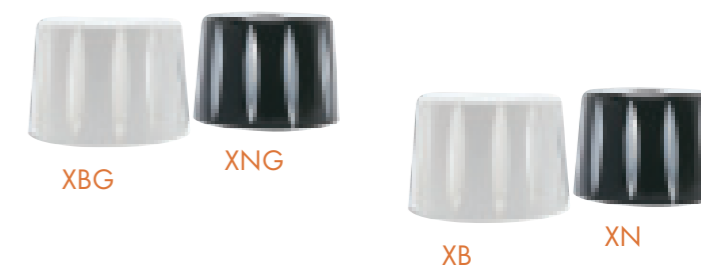
**MOD. YG**

Vetro inciso per lampadario
Etched glass for chandelier
Verre gravé pour lustre
Lampenglas geschliffen für Hängeleuchte
Стекло гравированная люстра
cm 12 L x 12 P x 12 H

**MOD. M/N/O**

Vetro satinato colorato
Colored sand glass
Verre satiné coloré
Glas, satiniert, farbig
Стекло гравированная люстра
cm Ø 15 x 10 P

• M - Bianco / white / blanc / weiß

• N - Blu / blue / bleu / blau

• O - Verde / green / vert / grün

- Con applique (maggiorazione)
With applique (supplement)
Avec applique (supplément)
Mit Wandleuchte (Zuschlag)

С аппликацией (за дополнительную плату)



Caldo benessere

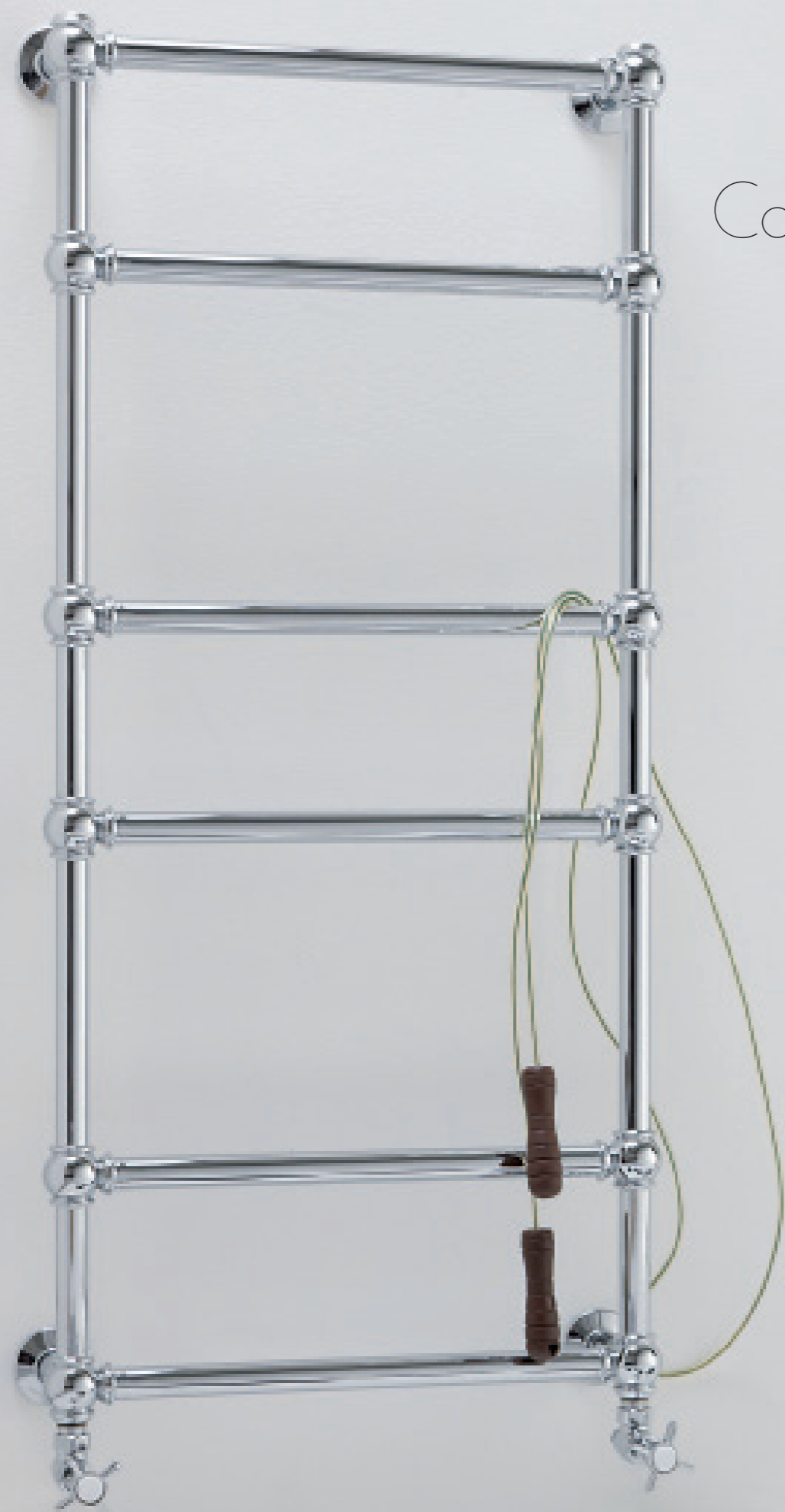

TERMO- ARREDI E PLACCCHE

Design/Designer: Stilhaus
Materiale: ottone, Tubo Ø28, basetta a muro Ø 70
Finitura: 08-16-25
Fuori misura: Sì
- in larghezza, con aumento del 10% dal prezzo di listino
- in altezza, a preventivo
- con aggiunta di elementi, a preventivo

Designer: Stilhaus
Material: Brass tube Ø 28, fixing plate cover Ø 70
Finishes: 08-16-25
Customized: Yes
- in width, with a 10% increase from the price list
- in height, to quote
- with the addition of element, to quote

Designer: Stilhaus
Matière: Laiton, tuyau Ø 28, boucle couvre-vis Ø 70
Finitions: 08-16-25
Personnalisè: Oui
- en largeur, avec une augmentation de 10% du prix de list
- hauteur, faire une estimation
- avec des éléments ajoutés, faire une estimation

Designer: Stilhaus
Material: Messing Rohr Ø28, Angriff Ø70
Zubehör: Mattglas
Ausführungen: 08-16-25
Kundenwunsch: Ja
- die Breite mit 10% Preisauflschlag
- die Höhe gegen Kostenvoranschlag
- zusätzliche Elemente gegen Kostenvoranschlag

Дизайн: Stil Haus
Материал: латунь
Варианты цвета: 08-16-25
Варианты под заказ:
По ширине, с увеличением на 10% от цены прайс-листа
по высоте, по запросу
с добавлением элементов, по запросу

1020

Scalda asciugamani in ottone a parete, versione acqua calda
 Brass wall towel warmer, hot water version
 Warmwasser-Wandhandtuchwärmer aus Messing, Warmwasser-Version

Полотенцесушитель водяной, латунь
 Cm 60 H x 57 L x 14 P Int 50
 Δ 50°C 165 KCAL/H

- 08
- 25-16

1020 E

Scalda asciugamani in ottone a parete, versione elettrica 270 W
 Brass wall towel warmer, electric version 270 W
 Warmwasser-Wandhandtuchwärmer aus Messing, elektrische Version (270W)

Полотенцесушитель электрический 270 W, латунь
 Cm 60 H x 57 L x 14 P Int 50
 Δ 50°C 180 W

- 08
- 25-16

1024

Valvola e detentore completi
 Valve and lockshield
 Ventile und Drossel
 клапана и вентеля в комплекте

- 08
- 25-16

1025

Tubetti di collegamento
 Connecting pipes
 Verbindungsstücke
 трубки для подключения

- 08
- 25-16

1026

Termostato
 Thermostat
 Thermostat
 Терморегулятор

- 01



1021

Scalda asciugamani in ottone a parete, versione acqua calda
 Brass wall towel warmer, hot water version
 Warmwasser-Wandhandtuchwärmer aus Messing, Warmwasser-Version

полотенцесушитель водяной, латунь
 Cm 80 H x 57 L x 14 P Int 50
 Δ 50°C 270 KCAL/H

- 08
- 25-16

1021 E

Scalda asciugamani in ottone a parete, versione elettrica 270 W
 Brass wall towel warmer, electric version 270 W
 Warmwasser-Wandhandtuchwärmer aus Messing, elektrische Version (270W)

полотенцесушитель электрический 270 W, латунь
 Cm 80 H x 57 L x 14 P Int 50
 Δ 50°C 285 W

- 08
- 25-16

1024

Valvola e detentore completi
 Valve and lockshield
 Ventile und Drossel
 клапана и вентеля в комплекте

- 08
- 25-16

1025

Tubetti di collegamento
 Connecting pipes
 Verbindungsstücke
 трубки для подключения

- 08
- 25-16

1026

Termostato
 Thermostat
 Thermostat
 Терморегулятор

- 01

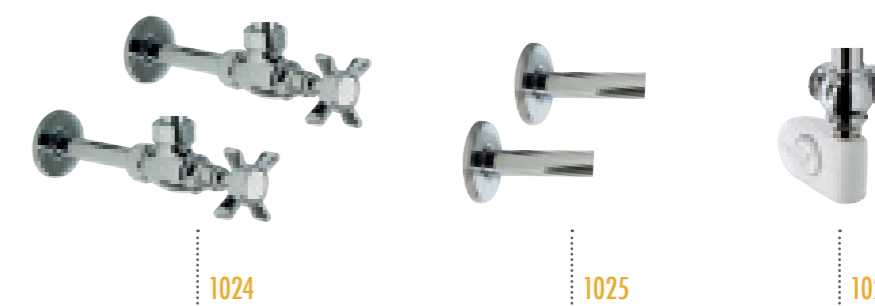

1022

Scalda asciugamani in ottone a parete, versione acqua calda
 Brass wall towel warmer, hot water version
 Warmwasser-Wandhandtuchwärmer aus Messing, Warmwasser-Version
 Полотенцесушитель водяной, латунь
 Cm 120 H x 57 L x 14 P Int 50
 Δ 50°C 345 KCAL/H

- 08
- 25-16

1022 E

Scalda asciugamani in ottone a parete, versione elettrica 270 W
 Brass wall towel warmer, electric version 270 W
 Warmwasser-Wandhandtuchwärmer aus Messing, elektrische Version (270W)
 Полотенцесушитель электрический 270 W, латунь
 Cm 120 H x 57 L x 14 P Int 50
 Δ 50°C 360 W

- 08
- 25-16

1024

Valvola e detentore completi
 Valve and lockshield
 Ventile und Drossel
 клапана и вентеля в комплекте

- 08
- 25-16

1025

Tubetti di collegamento
 Connecting pipes
 Verbindungsstücke
 трубки для подключения

- 08
- 25-16

1026

Termostato
 Thermostat
 Thermostat
 Терморегулятор

- 01

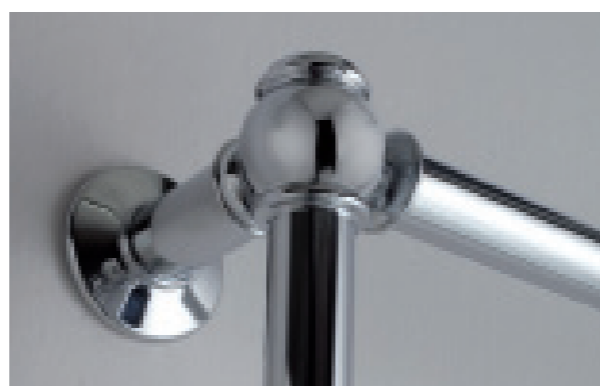

G 1021

Scalda asciugamani in ottone a parete, versione acqua calda
 Brass wall towel warmer, hot water version
 Warmwasser-Wandhandtuchwärmer aus Messing, Warmwasser-Version
 полотенецесушитель водяной, латунь
 Cm 80 H x 57 L x 14 P Int 50
 Δ 50°C 270 KCAL/H

- 08
- 25-16

G 1021 E

Scalda asciugamani in ottone a parete, versione elettrica 270 W
 Brass wall towel warmer, electric version 270 W
 Warmwasser-Wandhandtuchwärmer aus Messing, elektrische Version (270W)
 полотенецесушитель электрический 270 W, латунь
 Cm 80 H x 57 L x 14 P Int 50
 Δ 50°C 285 W

- 08
- 25-16

1024

Valvola e detentore completi
 Valve and lockshield
 Ventile und Drossel
 клапана и вентеля в комплекте

- 08
- 25-16

1025

Tubetti di collegamento
 Connecting pipes
 Verbindungsstücke
 трубки для подключения

- 08
- 25-16

1026

Termostato
 Thermostat
 Thermostat
 Терморегулятор

- 01

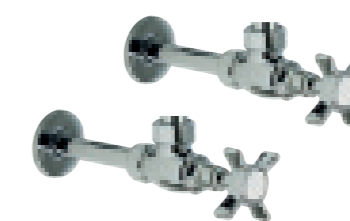

1024



1025



1026



1098

Placca comando per cassetta incasso mod. Geberit, compatibile con Unica+, Combifix e Duofix dotate del corpo cassetta UP320 o simili
 Plate for Geberit Waste System featuring with Unica+, Combifix e Duofix that mounted body UP320 or similar
 Drückerplatte für Geberit Installationssysteme (Unica+, Combifix und Duofix), die mit UP320 Kassettengehäuse oder ähnlichem ausgestattet sind.
 Клавиша смыва для бачков скрытого монтажа Geberit с Unica+, Combifix e Duofix установленных в бачки UP320 или подобные
 cm 33LxP2,5xH17

• 08 - cromo / chrome / chrome / chrom / хром



1098

Placca comando per cassetta incasso mod. Geberit, compatibile con Unica+, Combifix e Duofix dotate del corpo cassetta UP320 o simili
 Plate for Geberit Waste System featuring with Unica+, Combifix e Duofix that mounted body UP320 or similar
 Drückerplatte für Geberit Installationssysteme (Unica+, Combifix und Duofix), die mit UP320 Kassettengehäuse oder ähnlichem ausgestattet sind.
 Клавиша смыва для бачков скрытого монтажа Geberit с Unica+, Combifix e Duofix установленных в бачки UP320 или подобные
 cm 33LxP2,5xH17

• 16 - oro / gold / or / gold / Золото



1098

Placca comando per cassetta incasso mod. Geberit, compatibile con Unica+, Combifix e Duofix dotate del corpo cassetta UP320 o simili
 Plate for Geberit Waste System featuring with Unica+, Combifix e Duofix that mounted body UP320 or similar
 Drückerplatte für Geberit Installationssysteme (Unica+, Combifix und Duofix), die mit UP320 Kassettengehäuse oder ähnlichem ausgestattet sind.
 Клавиша смыва для бачков скрытого монтажа Geberit с Unica+, Combifix e Duofix установленных в бачки UP320 или подобные
 cm 33LxP2,5xH17

• 25 - bronzo / bronze / bronze / bronze / Бронза



1098

Placca comando per cassetta incasso mod. Geberit, compatibile con Unica+, Combifix e Duofix dotate del corpo cassetta UP320 o simili
 Plate for Geberit Waste System featuring with Unica+, Combifix e Duofix that mounted body UP320 or similar
 Drückerplatte für Geberit Installationssysteme (Unica+, Combifix und Duofix), die mit UP320 Kassettengehäuse oder ähnlichem ausgestattet sind.
 Клавиша смыва для бачков скрытого монтажа Geberit с Unica+, Combifix e Duofix установленных в бачки UP320 или подобные
 cm 33LxP2,5xH17

• 12 - nichel lucido polish nikel / nikel poli / nikel poliert / Глянцевый никель



Funzioni decise
per esigenze infinite



PIANTANE E
COLONNE
ATTREZZATE

Designer: Stilhaus
Fuori misura: Sì

Designer: Stilhaus
Customized: Yes

Designer: Stilhaus
Personnalis : Oui

Designer: Stilhaus
Kundenspezifische: Ja

Разработка дизайна: Stilhaus
Негабаритный: да

ZE 19

Piantana con 2 portasciugamani
Free-standing upright with 2 towel holders
Montant autonome avec 2 porte serviette
Handtuchständer 2 armig

Стойка: 2 полотенцедержателя
base ovale cm 22 L x 17 P / 90 H - 33 L

• 08

ZE 20

Piantana: porta rotolo e scopino
Free-standing upright: paper holder and
toilet-brush holder

Montant autonome: porte rouleau et porte balayent
Ständer: Papierrollenhalter und Bürstengarnitur

Стойка: бумагодержатель +
ерш керамический

base ovale cm 13 L x 16 P 70 H

• 08 bianco / white / blanc / weiß

• 08 colorato / colored / coloré / farbig

ZE 21

Piantana: porta salviette, porta sapone, porta
rotolo e scopino

Free-standing upright: serviette holder, soap dish,
paper and toilet-brush holder

Montant autonome: porte serviette, porte savon, porte
rouleau et porte balayent

Ständer: Handtuchhalter, Seifenschale,
Papierrollenhalter und Bürstengarnitur

Стойка: ёрш керамический +
мыльница + бумагодержатель +

полотенцедержатель

base ovale cm 13 L x 16 P x 80 H

• 08 bianco / white / blanc / weiß

• 08 colorato / colored / coloré / farbig

- * Con dosatore sapone liquido (maggiorazione)
With liquid soap dispenser (supplement)
Avec doseur de savon liquid (supplément)
Mit Seifenspender (Zuschlag)
с дозатором (дополнительно)

ZEFIRO

design Claudio Papa
realizzata in ottone / realized in brass / réalisée en laiton / aus Messing hergestellt / Сделано из латуни



ZE 19



ZE 20



ZE 21

QUID

design Claudio Papa
realizzata in ottone / realized in brass / réalisée en laiton / aus Messing hergestellt / Сделано из латуни

Q 19

Piantana con 3 portasciugamani
Free-standing upright with 3 towel holders
Montant autonome avec 3 porte serviette
Handtuchständer 3 armig

Стойка: 3 полотенцедержателя
base cm 19 L x 14 P / 90 H - 32 L

• 08

Q 20

Piantana: porta rotolo e scopino
Free-standing upright: paper holder
and toilet-brush holder

Montant autonome: porte rouleau et porte balayent
Ständer: Papierrollenhalter und Bürstengarnitur

Стойка: бумагодержатель +
ерш металлический

base cm 19 L x 14 P x 70 H

• 08

Q 817

Piantana porta accappatoio con 3 portasciugamani
Free-standing upright bathrobe with 3 towel holders
Montant autonome peignoir avec 3 porte serviette
Bademantelständer 3 armig

Стойка для халата и под 3 полотенца
base cm 22 L x 22 P / 175 H - 32 L

• 08

Q 21

Piantana: scopino, porta sapone,
porta asciugamani e porta rotolo

Free-standing upright: toilet brush holder,
soap dish, towel holder and paper holder

Montant autonome: porte balayent, porte savon, porte
serviette et porte rouleau

Ständer: Bürstengarnitur, Seifenschale,
Handtuchhalter und Papierrollenhalter

Стойка: ёрш металлический +
мыльница + бумагодержатель +

полотенцедержатель

base cm 19 L x 14 P x 85 H

• 08

- * Con dosatore sapone liquido (maggiorazione)
With liquid soap dispenser (supplement)
Avec doseur de savon liquid (supplément)
Mit Seifenspender (Zuschlag)
с дозатором (дополнительно)



Q 19



Q 20



Q 21



Q 817



780 URANIA

Scaletta portasalviette
Ladder towel holder
Escalier porte serviettes
Handtuchleiter

полотенцедержатель напольный
cm 42 L x 142 H

• 08 - 23

U 19

Piantana con 2 portasciugamani
Free-standing upright with 2 towel holders
Montant autonome avec 2 porte serviette
Handtuchständer 2 armig

Стойка для 2-ух полотенец
base cm 19 L x 14 P / 83 H - 30/28 L

• 08 - 23

U 20

Piantana: porta rotolo e scopino ceramica
Free-standing upright: paper holder
and toilet-brush holder
Montant autonome: porte rouleau et
porte balayent en ceramique
Ständer: Papierrollenhalter und
Bürstengarnitur aus Keramik

Стойка: бумагодержатель + ерш керамический
base cm 19 L x 14 P x 70 H

• 08 - 23

URANIA

realizzata in ottone / realized in brass / réalisée en laiton / aus Messing hergestellt / Сделано из латуни

**URANIA**

realizzata in ottone / realized in brass / réalisée en laiton / aus Messing hergestellt / Сделано из латуни

U 20 M

Piantana: porta rotolo e scopino ottone
Free-standing upright: paper holder
and toilet-brush holder brass
Montant autonome: porte rouleau et porte balayent
en laiton
Ständer: Papierrollenhalter und Bürstengarnitur
aus Messing

Стойка: ерш металлический+
бумагодержатель

base cm 11 L x 11 P x 70 H

• 08 - 23

U 21

Piantana: scopino ceramica, p. sapone,
p. asciugamani e p. rotolo
Free-standing upright: toilet brush holder, soap
dish, towel holder and paper holder
Montant autonome: porte balayent, porte savon, porte
serviette et porte rouleau
Ständer: Bürstengarnitur, Seifenschale, Handtuchhalter
und Papierrollenhalter

Стойка: ерш керамический+
мыльница+бумагодержатель+
полотенцедержатель

base cm 19 L x 14 P x 80 H

• 08 - 23

* Con dosatore sapone liquido (maggiorazione)
With liquid soap dispenser (supplement)
Avec doseur de savon liquid (supplément)
Mit Seifenspender (Zuschlag)
с дозатором (дополнительно)

U 21 M

Piantana: scopino ottone, p. sapone,
p. asciugamani e p. rotolo
Free-standing upright: toilet brush holder,
soap dish, towel holder and paper holder
Montant autonome: porte balayent,
porte savon, porte serviette et porte rouleau
Ständer: Bürstengarnitur, Seifenschale,
Handtuchhalter und Papierrollenhalter

Стойка: ерш металлический+
мыльница+бумагодержатель+
полотенцедержатель

base cm 19 L x 14 P x 80 H

• 08 - 23

* Con dosatore sapone liquido (maggiorazione)
With liquid soap dispenser (supplement)
Avec doseur de savon liquid (supplément)
Mit Seifenspender (Zuschlag)
с дозатором (дополнительно)



NERO OPACO
Matt black
Noir opaque
Matt schwarz
черный
матовый



ME 19

Piantana con 2 portasciugamani
Free-standing upright with 2 towel holders
Montant autonome avec 2 porte serviette
Handtuchständer 2 armig
Стойка для 2-ух полотенец
base cm Ø 22 / 83 H - 28/30 L

• 08 - 23

1158

Cavalletto portasciugamani
Free-standing towel holders
Montant autonome porte serviette
Handtuchständer
полотенцедержатель напольный
cm 55 L x 32 P x 82 H

• 08 - 23

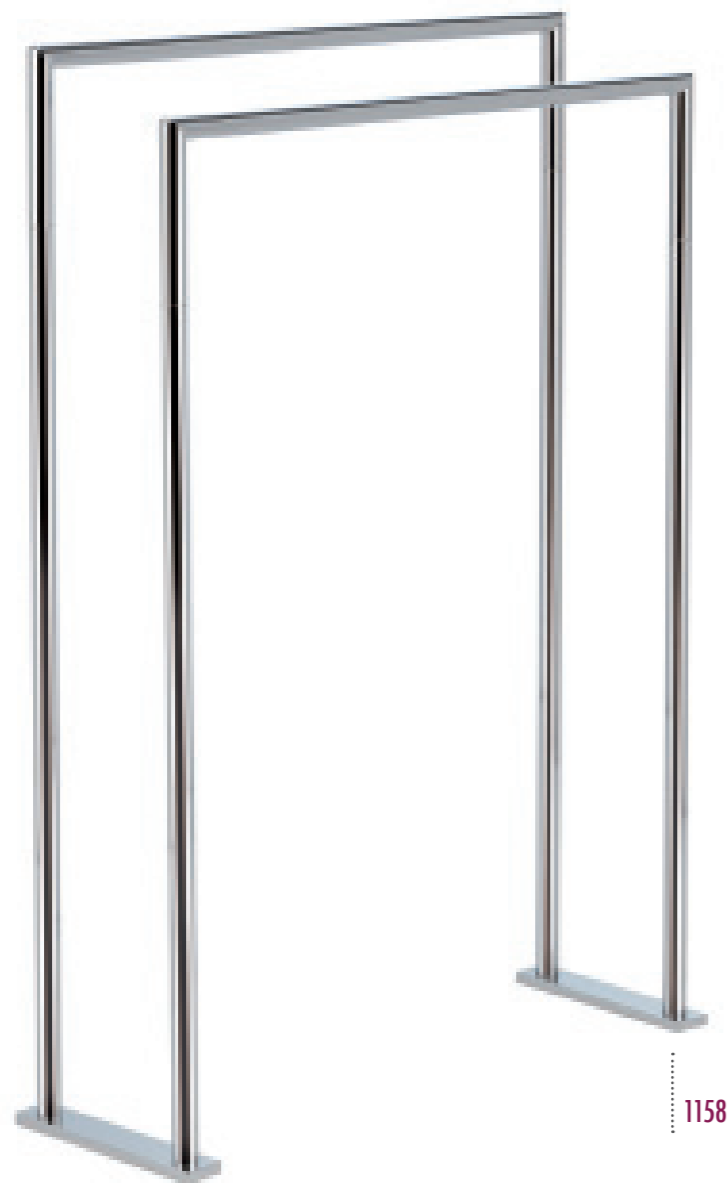

1158

MEDEA

realizzata in ottone / realized in brass / réalisée en laiton / aus Messing hergestellt / Сделано из латуни

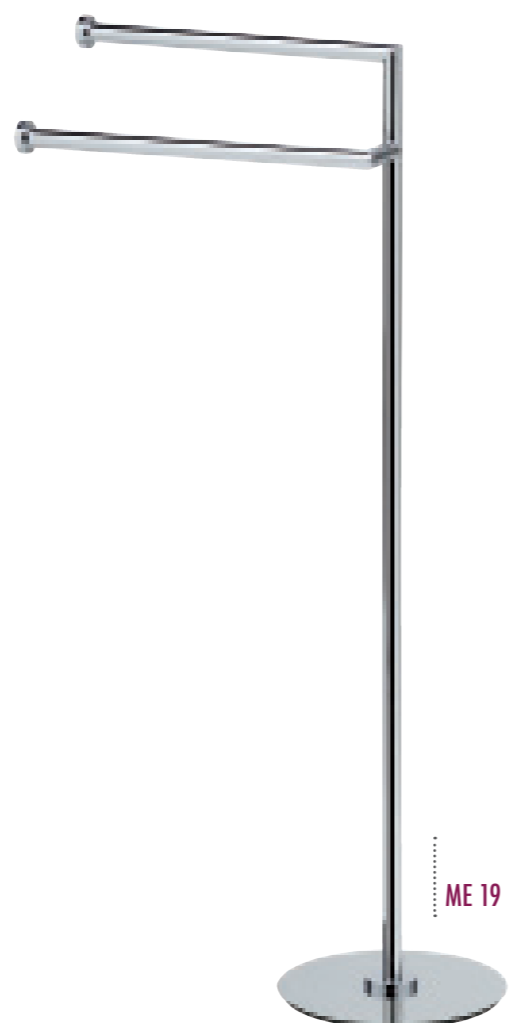

ME 19

realizzata in ottone / realized in brass / réalisée en laiton / aus Messing hergestellt / Сделано из латуни

MEDEA**ME 20**

Piantana: porta rotolo e scopino
Free-standing upright: paper holder and toilet-brush holder
Montant autonome: porte rouleau et porte balayent
Ständer: Papierrollenhalter und Bürstengarnitur
Стойка: бумагодержатель+ерш
металлический
base cm Ø 13 x 70 H

• 08 - 23

ME 972

Piantana: porta rotolo e scopino ceramica
Free-standing upright: paper holder and toilet-brush holder
Montant autonome: porte rouleau et porte balayent en ceramique
Ständer: Papierrollenhalter und Bürstengarnitur aus Keramik
Стойка: бумагодержатель+ерш керамический
base cm 12 L x 14 P x 65 H

• 08 - 23

ME 21

Piantana: scopino, porta sapone, porta asciugamani e porta rotolo
Free-standing upright: toilet brush holder, soap dish, towel holder and paper holder
Montant autonome: porte balayent, porte savon, porte serviette et porte rouleau
Ständer: Bürstengarnitur, Seifenschale, Handtuchhalter und Papierrollenhalter
Стойка: ёрш металлический+мыльница+бумагодержатель+полотенцедержатель
base cm Ø 17 x 80 H

• 08 - 23

* Con dosatore sapone liquido (maggiorazione)
With liquid soap dispenser (supplement)
Avec doseur de savon liquid (supplement)
Mit Seifenspender (Zuschlag)
с дозатором (дополнительно)



ME 972

ME 20

ME 21

FINITURA DISPONIBILE IN 20 GG.

Finish available in 20 days
Finition disponible en 20 jours
Oberfläche lieferbar in 20 Tagen
Отделка доступны в течение 20 дней



NERO OPACO
Matt black
Noir opaque
Matt schwarz
хром

**23**

DI 19

Piantana con 2 portasciugamani
Free-standing upright with 2 towel holders
Montant autonome avec 2 porte serviette
Handtuchständer 2 armig

Стойка для 2-ух полотенец
base cm 19 L x 14 P / 83 H - 28/30 L

• 08

DI 20

Piantana: porta rotolo e scopino
Free-standing upright: paper holder
and toilet-brush holder

Montant autonome: porte rouleau et
porte balayent

Ständer: Papierrollenhalter und Bürstengarnitur

Стойка: бумагодержатель+ёрш металлический
base cm 19 L x 14 P 62 H

• 08

DI 21

Piantana: scopino, porta sapone,
porta asciugamani e porta rotolo

Free-standing upright: toilet brush holder,
soap dish, towel holder and paper holder

Montant autonome: porte balayent,
porte savon, porte serviette et porte rouleau

Ständer: Bürstengarnitur, Seifenschale,
Handtuchhalter und Papierrollenhalter

Стойка: ёрш металлический+
мыльница+бумагодержатель+
полотенцедержатель

base cm 19 L x 14 P x 80 H

• 08

- * Con dosatore sapone liquido (maggiorazione)
With liquid soap dispenser (supplement)
Avec doseur de savon liquid (supplément)
Mit Seifenspender (Zuschlag)
с дозатором (дополнительно)

DIANA

realizzata in ottone / realized in brass / réalisée en laiton / aus Messing hergestellt / Сделано из латуни



DI 19



DI 20



DI 21

LIZ

855

Piantana con 2 portasciugamani
Free-standing upright with 2 towel holders
Montant autonome avec 2 porte serviette
Handtuchständer 2 armig

Стойка для 2-ух полотенец
base cm Ø 22 x 88 H - 34 L

• 08

856

Piantana: porta rotolo e scopino
Free-standing upright: paper holder
and toilet-brush holder

Montant autonome: porte rouleau et porte balayent

Ständer: Papierrollenhalter und Bürstengarnitur

Стойка: 3 крючка под халаты и 3
полотенцедержателя

base cm Ø 17 x 62 H

• 08

858

Piantana porta accappatoio
con 3 portasciugamani

Free-standing upright bathrobe with 3 towel holders
Montant autonome peignoir avec 3 porte serviette

Bademantelständer 3 armig

Стойка: 3 крючка под халаты и 3
полотенцедержателя

base cm Ø 22 x 180 H - 34 L

• 08

857

Piantana: scopino, porta sapone, porta asciugamani
e porta rotolo

Free-standing upright: toilet brush holder, soap dish,
towel holder and paper holder

Montant autonome: porte balayent, porte savon, porte
serviette et porte rouleau

Ständer: Bürstengarnitur, Seifenschale,
Handtuchhalter und Papierrollenhalter

Стойка: ёрш металлический+
мыльница+бумагодержатель+
полотенцедержатель

base cm Ø 17 x 72 H

• 08

- * Con dosatore sapone liquido (maggiorazione)
With liquid soap dispenser (supplement)
Avec doseur de savon liquid (supplément)
Mit Seifenspender (Zuschlag)
с дозатором (дополнительно)

realizzata in ottone / realized in brass / réalisée en laiton / aus Messing hergestellt / Сделано из латуни



855



856



857



858



572

Piantana con 3 portasciugamani
Free-standing upright with 3 towel holders
Montant autonome avec 3 porte serviette
Handtuchständer 3 armig
Стойка для 3-х халатов
base cm Ø 28 / 90 H - 31 L

• 08

573

Piantana: porta rotolo e scopino
Free-standing upright: paper holder
and toilet-brush holder
Montant autonome: porte rouleau et
porte balayent
Ständer: Papierrollenhalter und Bürstengarnitur
Стойка: бумагодержатель+
ерш стеклянный
base cm Ø 20 x 77 H

• 08

574

Piantana: scopino, porta sapone,
porta asciugamani e porta rotolo
Free-standing upright: toilet brush holder,
soap dish, towel holder and paper holder
Montant autonome: porte balayent,
porte savon, porte serviette et porte rouleau
Ständer: Bürstengarnitur, Seifenschale,
Handtuchhalter und Papierrollenhalter
Стойка: ёрш стеклянный+
мыльница+бумагодержатель+
полотенцедержатель
base cm Ø 20 x 77 H

• 08

* Con dosatore sapone liquido (maggiorazione)
With liquid soap dispenser (supplement)
Avec doseur de savon liquid (supplément)
Mit Seifenspender (Zuschlag)
с дозатором (дополнительно)

VENUS

realizzata in ottone / realized in brass / réalisée en laiton / aus Messing hergestellt / Сделано из латуни



PRISMA

realizzata in ottone / realized in brass / réalisée en laiton / aus Messing hergestellt / Сделано из латуни

PR 19

Piantana con 3 portasciugamani
Free-standing upright with 3 towel holders
Montant autonome avec 3 porte serviette
Handtuchständer 3 armig
Стойка: 3 полотенецдержателя
base cm Ø 25 x 90 H - 32/29/27 L

• 08

• 02

• 16 - 25 - 26

PR 20

Piantana: porta rotolo e scopino
Free-standing upright: paper holder
and toilet-brush holder
Montant autonome: porte rouleau et porte balayent
Ständer: Papierrollenhalter und Bürstengarnitur
Стойка: бумагодержатель +
ерш металлический
base cm Ø 20 x 65 H

• 08

• 02

• 16 - 25 - 26

PR 21

Piantana: scopino, porta sapone,
porta asciugamani e porta rotolo
Free-standing upright: toilet brush holder,
soap dish, towel holder and paper holder
Montant autonome: porte balayent, porte savon, porte
serviette et porte rouleau
Ständer: Bürstengarnitur, Seifenschale,
Handtuchhalter und Papierrollenhalter
Стойка: ёрш металлический +
мыльница + бумагодержатель +
полотенцедержатель
base cm Ø 20 x 75 H

• 08

• 02

• 16 - 25 - 26

* Con dosatore sapone liquido (maggiorazione)
With liquid soap dispenser (supplement)
Avec doseur de savon liquid (supplément)
Mit Seifenspender (Zuschlag)
с дозатором (дополнительно)



1123

Piantana con 2 portasciugamani
Free-standing upright with 2 towel holders
Montant autonome avec 2 porte serviette
Handtuchständer 2 armig

Стойка для 2-ух полотенец
cm 90 H - 29 L • Base Ø 22

• 08

1123/3

Piantana con 3 portasciugamani
Free-standing upright with 3 towel holders
Montant autonome avec 3 porte serviette
Handtuchständer 3 armig

Стойка для 3-ух полотенец
cm 98 H - 29 L • Base Ø 22

• 08

970

Piantana: porta salviette e porta sapone
Free-standing upright: serviette holder and soap dish
Montant autonome 2 fonctions: porte serviette et porte savon
Ständer: Handtuchhalter und Seifenschale

Стойка: полотенцедержатель + мыльница
base cm Ø 13 L x 65 H

• Con porta sapone
With soap dish
Avec porte savon
Mit Seifenschale

* • Con dosatore sapone liquido (maggiorazione)
With liquid soap dispenser (supplement)
Avec doseur de savon liquid (supplément)
Mit Seifenspender (Zuschlag)
с дозатором (дополнительно)

HASHI

realizzata in ottone / realized in brass / réalisée en laiton / aus Messing hergestellt / Сделано из латуни



970

1123

1123/3

HASHI

realizzata in ottone / realized in brass / réalisée en laiton / aus Messing hergestellt / Сделано из латуни

969

Piantana: porta rotolo e scopino ottone
Free-standing upright: paper holder toilet-brush
Montant autonome: porte rouleau et porte balayent
Ständer: Papierrollenhalter und Bürstengarnitur

Стойка: бумагодержатель + ерш
металлический
base cm Ø 13 x 64 H

• 08

972

Piantana: porta rotolo e scopino ceramica
Free-standing upright: paper holder
and toilet-brush holder
Montant autonome: porte rouleau et porte balayent
Ständer: Papierrollenhalter und Bürstengarnitur

Стойка: бумагодержатель +
ерш металлический керамика
base cm Ø 13 x 64 H

• 08

971

Piantana: scopino ottone, porta sapone, porta
asciugamani e porta rotolo
Free-standing upright: toilet brush holder, soap dish,
towel holder and paper holder
Montant autonome: porte balayent, porte savon, porte
serviette et porte rouleau

Ständer: Bürstengarnitur, Seifenschale,
Handtuchhalter und Papierrollenhalter
Стойка: мыльница + полотенцедержатель +
бумагодержатель + ерш металлический
base cm Ø 13 x 73 H

• 08

* • Con dosatore sapone liquido (maggiorazione)
With liquid soap dispenser (supplement)
Avec doseur de savon liquid (supplément)
Mit Seifenspender (Zuschlag)
с дозатором (дополнительно)



971

969

972



i 19

Piantana con 2 portasciugamani
Free-standing upright with 2 towel holders
Montant autonome avec 2 porte serviette
Handtuchständer 2 armig

Стойка для полотенец
base cm Ø 25 / 90 H - 32/26 L

- 08 - 12
- 25 - 26

i 20

Piantana: porta rotolo e scopino
Free-standing upright: paper holder
and toilet-brush holder
Montant autonome: porte rouleau et porte balayent
Ständer: Papierrollenhalter und Bürstengarnitur

Стойка: бумагодержатель +
ерш керамический
base cm Ø 20 x 65 H

- 08 - 12
- 25 - 26

i 21

**Piantana: scopino, porta sapone, porta asciugamani
e porta rotolo**

Free-standing upright: toilet brush holder,
soap dish, towel holder and paper holder
Montant autonome: porte balayent,
porte savon, porte serviette et porte rouleau
Ständer: Bürstengarnitur, Seifenschale,
Handtuchhalter und Papierrollenhalter

Стойка: ёрш керамический +
мыльница + бумагодержатель +
полотенцедержатель
base cm Ø 20 x 83 H

- 08 - 12
- 25 - 26

IDRA

realizzata in ottone / realized in brass / réalisée en laiton / aus Messing hergestellt / Сделано из латуни



NEMI

realizzata in ottone / realized in brass / réalisée en laiton / aus Messing hergestellt / Сделано из латуни

N 19

Piantana con 3 portasciugamani
Free-standing upright with 3 towel holders
Montant autonome avec 3 porte serviette
Handtuchständer 3 armig

Стойка: 3 полотенецдержателя
base cm Ø 25 / 90 H - 34 L

- 33 - 39
- 40

N 20

Piantana: porta rotolo e scopino
Free-standing upright: paper holder
and toilet-brush holder
Montant autonome: porte rouleau et porte balayent
Ständer: Papierrollenhalter und Bürstengarnitur

Стойка: бумагодержатель +
ерш металлический
base cm Ø 20 x 65 H

- 33 - 39
- 40

N 21

**Piantana: scopino, porta sapone, porta asciugamani
e porta rotolo**

Free-standing upright: toilet brush holder,
soap dish, towel holder and paper holder
Montant autonome: porte balayent,
porte savon, porte serviette et porte rouleau
Ständer: Bürstengarnitur, Seifenschale,
Handtuchhalter und Papierrollenhalter

Стойка: ёрш металлический +
мыльница + бумагодержатель +
полотенцедержатель
base cm Ø 20 x 75 H

- 33 - 39
- 40

N 23

**Piantana porta accappatoio
con 3 portasciugamani**
Free-standing upright bathrobe with 3 towel holders
Montant autonome peignoir avec 3 porte serviette
Bademantelständer 3 armig

Стойка: 3 крючка под халаты и 3
полотенцедержателя
base cm Ø 25 x 175 H

- 33 - 39
- 40



746 NESTOR

Portasciugamani
Free-standing towel holder
Montant autonome porte serviette
Handtuchständer

полотенцедержатель напольный
cm 58 L x 35 P x 80 H

- 08
- 02
- 16 - 25 - 26

741 MIRTA

Piantana porta accappatoio
con 3 portasciugamani
Free-standing upright bathrobe with 3 towel holders
Montant autonome peignoir avec 3 porte serviette
Bademantelständer 3 armig
Стойка: 3 крючка под халаты и 3
полотенцедержателя
base cm Ø 25 / 175 H - 34 L

- 08
- 02
- 16 - 25 - 26

ELITE

realizzata in ottone / realized in brass / réalisée en laiton / aus Messing hergestellt / Сделано из латуни

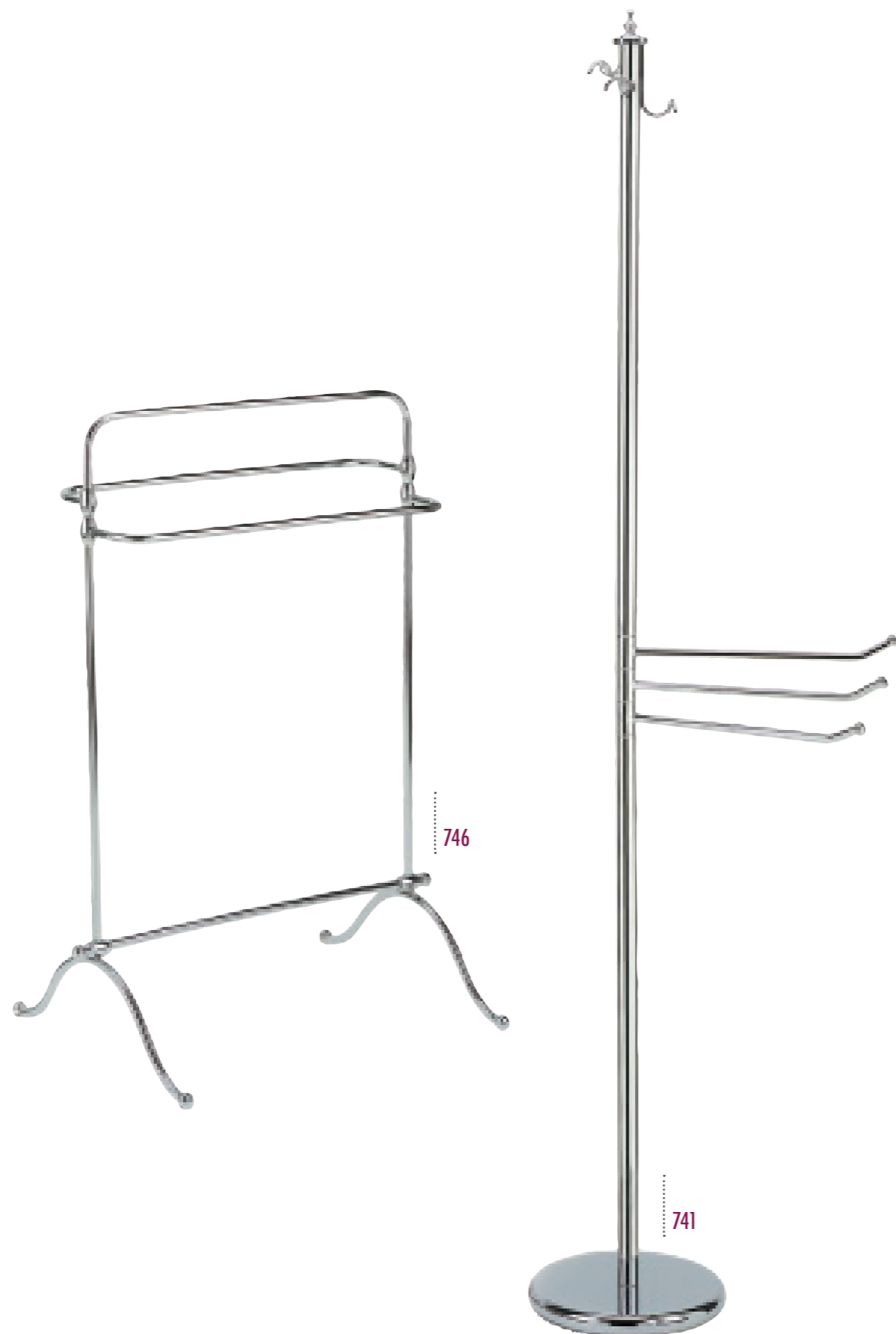
**ELITE**

realizzata in ottone / realized in brass / réalisée en laiton / aus Messing hergestellt / Сделано из латуни

**EL 19**

Piantana con 3 portasciugamani
Free-standing upright with 3 towel holders
Montant autonome avec 3 porte serviette
Handtuchständer 3 armig

Стойка: 3 полотенецдержателя
base cm Ø 25 x 90 H - 32/29/27 L

- 08
- 02
- 16 - 25 - 26

EL 20

Piantana: porta rotolo e scopino
Free-standing upright: paper holder
and toilet-brush holder
Montant autonome: porte rouleau et porte balayent
Ständer: Papierrollenhalter und Bürstengarnitur
Стойка: бумагодержатель +
ерш металлический
base cm Ø 20 x 65 H

- 08
- 02
- 16 - 25 - 26

EL 21

Piantana: scopino, porta sapone,
porta asciugamani e porta rotolo
Free-standing upright: toilet brush holder,
soap dish, towel holder and paper holder
Montant autonome: porte balayent, porte savon, porte
serviette et porte rouleau
Ständer: Bürstengarnitur, Seifenschale,
Handtuchhalter und Papierrollenhalter
Стойка: ёрш металлический +
мыльница + бумагодержатель +
полотенцедержатель
base cm Ø 20 x 75 H

- 08
- 02
- 16 - 25 - 26

* Con dosatore sapone liquido (maggiorazione)
With liquid soap dispenser (supplement)
Avec doseur de savon liquid (supplément)
Mit Seifenspender (Zuschlag)
с дозатором (дополнительно)



G 696

Piantana con 3 portasciugamani
Free-standing upright with 3 towel holders
Montant autonome avec 3 porte serviette
Handtuchständer 3 armig

Стойка для 3-х полотенец
base cm Ø 25 x 90 H - 25/28/31 L

- 08
- 02 - 03 - 04
- 16 - 25 - 26 - 33 - 35 - 36

G 691

Piantana: porta rotolo e scopino
Free-standing upright: paper holder
and toilet-brush holder
Montant autonome: porte rouleau et porte balayent
Ständer: Papierrollenhalter und Bürstengarnitur
Стойка: бумагодержатель + ерш

металлический
base cm Ø 20 x 65 H

- 08
- 02 - 03 - 04
- 16 - 25 - 26 - 33 - 35 - 36

GIUNONE

realizzata in ottone / realized in brass / réalisée en laiton / aus Messing hergestellt/Сделано из латуни

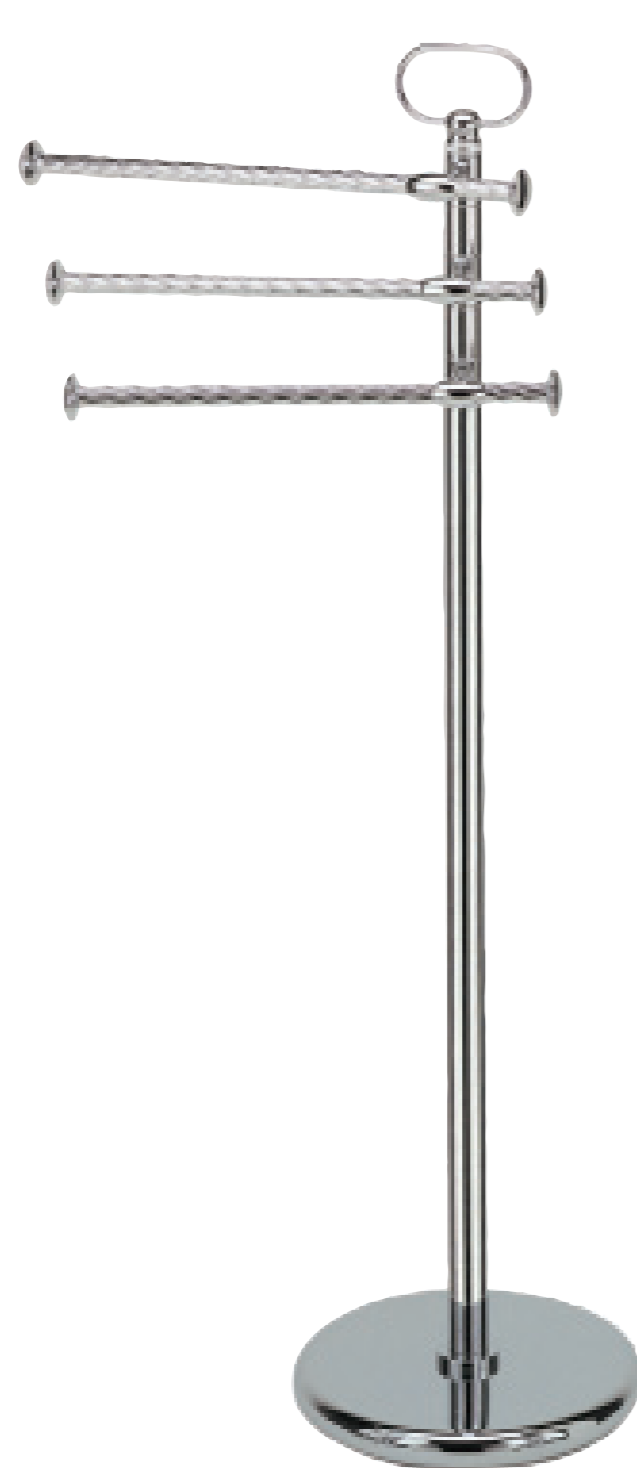
**G 697**

Piantana: scopino, porta sapone,
porta asciugamani e porta rotolo
Free-standing upright: toilet brush, soap dish,
towel holder and paper holder
Montant autonome: balayent, porte savon,
porte serviette et porte rouleau

Ständer: Bürstengarnitur, Seifenschale,
Handtuchhalter und Papierrollenhalter
Стойка: ерш металлический+
мыльница+бумагодержатель+
полотенцедержатель
base cm Ø 20 x 75 H

- 08
- 02 - 03 - 04
- 16 - 25 - 26 - 33 - 35 - 36

G 688

Piantana: scopino, porta sapone,
porta asciugamani e porta rotolo
Free-standing upright: toilet brush,
soap dish, towel holder and paper holder
Montant autonome: balayent, porte savon,
porte serviette et porte rouleau

Ständer: Bürstengarnitur, Seifenschale,
Handtuchhalter und Papierrollenhalter
Стойка: ерш керамический+
мыльница+ бумагодержатель
закрытый+полотенцедержатель
base cm Ø 25 x 95 H

- 08
- 02 - 03 - 04
- 16 - 25 - 26 - 33 - 35 - 36

U 24 URANIA

Colonna componibile a parete per lavabo
 Wall mounted modular column for washbasin
 Colonne à éléments à mur pour lavabo
 Stangensystem für Waschtisch-Set
 Настенная модульная колонна в комплектации для раковины

U 24 ASTA H cm 90
 Bar cm 90 H / Barre H cm 90 / Stange H cm 90

U 24.561 SPECCHIO INGRANDITORE CM. 12
 Enlarging mirror / Miroir agrandisseur /
 Vergrößerungsspiegel

U 24.05 ASTA PORTASCIUGAMANI CM. 35 L
 Towel holder / Porte serviette / Handtuchhalter

U 24.09 PORTA SAPONE
 Soap dish / Porte savon / Seifenschale

U 24.10 PORTA BICCHIERE
 Glass holder / Porte verre / Zahnbürstenhalter

COMPOSIZIONE COME FOTO
 Composition as photo
 Composition comme photo
 Kombination wie auf dem Bild
 Композиция как фото

U 25 URANIA

Colonna componibile a parete per wc/bidet
 Wall mounted modular column for wc/bidet
 Colonne à éléments à mur pour wc/bidet
 Stangensystem für WC/Bidet-Set
 Настенная модульная колонна в комплектации для унитаза/биде

U 25 ASTA H cm 70
 Bar cm 70 H / Barre H cm 70 / Stange H cm 70

U 25.06 ASTA PORTASCIUGAMANI CM. 25 L
 Towel holder / Porte serviette / Handtuchhalter

U 25.30 DOSATORE SAPONE LIQUIDO
 Dispenser liquid soap / Doseur de savon liquid / Seifenspender

U 25.11 PORTA ROTOLO
 Paper holder / Porte rouleau / Papierrollenhalter

U 25.039a PORTA SCOPINO QUADRO
 Square toilet brush / Porte balaynet cadre /
 Quadratische Bürstengarnitur

COMPOSIZIONE COME FOTO CM 75
 Composition as photo
 Composition comme photo
 Kombination wie auf dem Bild
 Композиция как фото

URANIA

realizzata in ottone / realized in brass / réalisée en laiton / aus Messing hergestellt / Сделано из латуни



U 24



U 25

QUID

design Claudio Papa

realizzata in ottone / realized in brass / réalisée en laiton / aus Messing hergestellt / Сделано из латуни

Q 24

Colonna componibile a parete per lavabo
 Wall mounted modular column for washbasin
 Colonne à éléments à mur pour lavabo
 Stangensystem für Waschtisch-Set
 Настенная модульная колонна в комплектации для раковины

Q 24 ASTA H cm 80
 Bar cm 80 H / Barre H cm 80 / Stange H cm 80

Q 24.05 ASTA PORTASCIUGAMANI CM. 35 L
 Towel holder / Porte serviette / Handtuchhalter

Q 24.09 PORTA SAPONE
 Soap dish / Porte savon / Seifenschale

Q 24.10 PORTA BICCHIERE
 Glass holder / Porte verre / Zahnbürstenhalter

COMPOSIZIONE COME FOTO
 Composition as photo
 Composition comme photo
 Kombination wie auf dem Bild
 Композиция как фото

Q 25

Colonna componibile a parete per wc/bidet
 Wall mounted modular column for wc/bidet
 Colonne à éléments à mur pour wc/bidet
 Stangensystem für WC/Bidet-Set
 Настенная модульная колонна в комплектации для унитаза/биде

Q 25 ASTA H cm 70
 Bar cm 70 H / Barre H cm 70 / Stange H cm 70

Q 25.06 ASTA PORTASCIUGAMANI CM. 25 L
 Towel holder / Porte serviette / Handtuchhalter

Q 25.30 DOSATORE SAPONE LIQUIDO
 Dispenser liquid soap / Doseur de savon liquid / Seifenspender

Q 25.11 PORTA ROTOLO
 Paper holder / Porte rouleau / Papierrollenhalter

Q 25.12 PORTA SCOPINO IN VETRO
 Glass toilet brush / Porte balaynet /
 Bürstengarnitur aus Glas

COMPOSIZIONE COME FOTO CM 75
 Composition as photo
 Composition comme photo
 Kombination wie auf dem Bild
 Композиция как фото



Q 24



Q 25

VE 24

Colonna componibile a parete per lavabo
 Wall mounted modular column for washbasin
 Colonne à éléments à mur pour lavabo
 Stangensystem für Waschtisch-Set
 Настенная модульная колонна в комплектации для раковины

VE 24 ASTA H cm 75
 Bar cm 75 H / Barre H cm 75 / Stange H cm 75

VE 26 ASTA H cm 95
 Bar cm 95 H / Barre H cm 95 / Stange H cm 95

VE 24.05 ASTA PORTASCUGAMANI cm 35 L
 Towel holder / Porte serviette / Handtuchhalter

VE 24.09 PORTA SAPONE
 Soap dish / Porte savon / Seifenschale

VE 24.10 PORTA BICCHERE
 Glass holder / Porte verre / Zahnbürstenhalter

VE 24.562 SPECCHIO INGRANDITORE cm 12x20
 Enlarging mirror / Miroir agrandisseur /
 Vergrößerungsspiegel

COMPOSIZIONE COME FOTO
 Composition as photo
 Composition comme photo
 Kombination wie auf dem Bild
 Композиция как фото

VE 25

Colonna componibile a parete per wc/bidet
 Wall mounted modular column for wc/bidet
 Colonne à éléments à mur pour wc/bidet
 Stangensystem für WC/Bidet-Set
 Настенная модульная колонна в комплектации для унитаза/биде

VE 25 ASTA H cm 65
 Bar cm 65 H / Barre H cm 65 / Stange H cm 65

VE 25.06 ASTA PORTASCUGAMANI cm 25 L
 Towel holder / Porte serviette / Handtuchhalter

VE 25.30 DOSATORE SAPONE LIQUIDO
 Dispenser liquid soap / Doseur de savon liquid / Seifenspender

VE 25.11 PORTA ROTOLO
 Paper holder / Porte rouleau / Papierrollenhalter

VE 25.12 PORTA SCOPPIO IN VETRO
 Glass toilet brush / Porte balayent /
 Bürstengarnitur aus Glas

COMPOSIZIONE COME FOTO cm 75
 Composition as photo
 Composition comme photo
 Kombination wie auf dem Bild
 Композиция как фото

VENUS

realizzata in ottone / realized in brass / réalisée en laiton / aus Messing hergestellt / Сделано из латуни



VE 25



VE 24



ME 24



ME 25

MEDEA

realizzata in ottone / realized in brass / réalisée en laiton / aus Messing hergestellt / Сделано из латуни

ME 24

Colonna componibile a parete per lavabo
 Wall mounted modular column for washbasin
 Colonne à éléments à mur pour lavabo
 Stangensystem für Waschtisch-Set
 Настенная модульная колонна в комплектации для раковины

ME 24 ASTA H cm 80
 Bar cm 80 H / Barre H cm 80 / Stange H cm 80

ME 24.05 ASTA PORTASCUGAMANI cm 35 L
 Towel holder / Porte serviette / Handtuchhalter

ME 24.09V PORTA SAPONE IN VETRO
 Glass soap dish / Porte savon en verre /
 Seifenschale aus Glas

ME 24.10V PORTA BICCHERE IN VETRO
 Glass holder / Porte verre / Zahnbürstenhalter

ME 24.10M PORTA BICCHERE IN METALLO
 Metal glass holder / Porte verre en métal /
 Zahnbürstenhalter aus Metall

ME 24.562 SPECCHIO INGRANDITORE
 Enlarging mirror / Miroir agrandisseur /
 Vergrößerungsspiegel

COMPOSIZIONE COME FOTO
 Composition as photo
 Composition comme photo
 Kombination wie auf dem Bild
 Композиция как фото

ME 25

Colonna componibile a parete per wc/bidet
 Wall mounted modular column for wc/bidet
 Colonne à éléments à mur pour wc/bidet
 Stangensystem für WC/Bidet-Set
 Настенная модульная колонна в комплектации для унитаза/биде

ME 25 ASTA H cm 70
 Bar cm 70 H / Barre H cm 70 / Stange H cm 70

ME 25.06 ASTA PORTASCUGAMANI cm 25 L
 Towel holder / Porte serviette / Handtuchhalter

ME 25.30 DOSATORE SAPONE LIQUIDO
 Dispenser liquid soap / Doseur de savon liquid / Seifenspender

ME 25.11 PORTA ROTOLO
 Paper holder / Porte rouleau / Papierrollenhalter

ME 25.039 PORTA SCOPPIO IN OTTONE
 Brass toilet brush / Porte balayent en laiton /
 Bürstengarnitur aus Messing

COMPOSIZIONE COME FOTO cm 75
 Composition as photo
 Composition comme photo
 Kombination wie auf dem Bild
 Композиция как фото

Rito di perfezione



OGGETTISTICA

Designer: Stilhaus, Lenarda, BGR, Papa, Settimelli

Designer: Stilhaus, Lenarda, BGR, Papa, Settimelli

Designer: Stilhaus, Lenarda, BGR, Papa, Settimelli

Designer: Stilhaus, Lenarda, BGR, Papa, Settimelli

Разработка дизайна: Stilhaus, Lenarda, BGR, Papa, Settimelli

LIQUID [design Claudio Papa]

792

Porta spazzolini / dosatore sapone liquido
in ceramica e ottone cromato

Ceramic and chromed brass
toothbrush holder / liquid soap dispenser
Porte brosses / porte savon liquid
en céramique et laiton chromée
Zahnbürstenhalter / Seifenspender
aus Keramik und verchromtem Messing
дозатор керамический + подставка для
зубных щёток
cm 16 L x 9,5 P x 18 H

- Bianca / white / blanc / weiß
- Colorato / colored / coloré / farbig



SOLID [design Claudio Papa]

791

Porta sapone / porta spazzolini
in ceramica e ottone cromato

Ceramic and chromed brass
soap dish / toothbrush holder
Porte savon / porte brosses
en céramique et laiton chromée
Seifenschale / Zahnbürstenhalter
aus Keramik und verchromtem Messing
мыльница керамическая + подставка для
зубных щёток
cm 20 L x 10 P x 10 H

- Bianca / white / blanc / weiß
- Colorato / colored / coloré / farbig



SOLID / LIQUID colori disponibili / available colours / couleurs disponibles / verfügbare Farben

BIANCO white blanc weiß белый	VERDE green vert grün зеленый	ROSSO red rouge rot красный	ARANCIO orange orangier orange оранжевый	LILLA lilac lille lila сирень	NERO black noir schwarz черный

ECO [design Gianluca Paludi]

1160

Porta spazzolini, diffusore musicale in ceramica
Ceramic toothbrush holder and music speaker

Porte brosses et haut-parleur musical en céramique
Zahnbürstenhalter mit Musik-Lautsprecher aus Keramik
дозатор керамический + подставка для
зубных щёток
cm 14 L x 18 P x 16 H

- Bianco / white / blanc / weiß
- Colorato / colored / coloré / farbig

ECO

colori disponibili / available colours /
couleurs disponibles / verfügbare Farben

BIANCO white blanc weiß белый	VERDE green vert grün зеленый	ROSSO red rouge rot красный
NERO black noir schwarz черный	MARRONE brown brun braun коричневый	GRIGIO grey gris gray серый



ECO: Modello registrato EU N. 004544708-0001
ECO: European Patent No. 004544708-0001
ECO: Brevet Européen No. 004544708-0001
ECO: Europäisches Patent Nr. 004544708-0001
ECO: Europäisches патент 004544708-0001

ZEFIRO [design Claudio Papa]

Serie in ceramica
Ceramic set
Série en céramique
Serie aus Keramik
серия из керамики

652

Porta sapone
Soap dish / Porte savon / Seifenschale /
настольная мыльница
cm 13 L x 8 P x 2 H

- Bianco / white / blanc / weiß
- Colorato / colored / coloré / farbig

653

Bicchiere
Glass / Verre / Zahnputzbecher /
настольный стакан
cm 13 L x 7 P x 10 H

- Bianco / white / blanc / weiß
- Colorato / colored / coloré / farbig

654

Dosatore sapone con pompetta in metallo
Liquid soap dispenser / Porte savon liquid /
Seifenspender / настольный дозатор
cm 10 L x 7 P x 19 H

- Bianco / white / blanc / weiß
- Colorato / colored / coloré / farbig



ZEFIRO colori disponibili / available colours / couleurs disponibles / verfügbare Farben

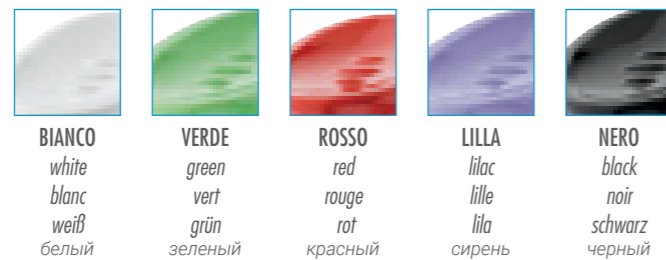

FAUL

Serie in ceramica bianca o colorata
White or coloured ceramic set
Série en céramique blanc ou colorée
Serie aus weißer oder farbiger Keramik
Серия с белой или цветной керамикой

794

Porta sapone
Soap dish / Porte savon / Seifenschale /
мыльница
cm 10 L x 10 P x 2 H

- Bianco / white / blanc / weiß
- Colorato / colored / coloré / farbig

793

Bicchiere
Glass / Verre / Zahnputzbecher / стакан
cm 13 L x 7 P x 10 H

- Bianco / white / blanc / weiß
- Colorato / colored / coloré / farbig

795

Dosatore sapone con pompetta in metallo
Liquid soap dispenser / Porte savon liquid /
Seifenspender / дозатор
cm 7,5 L x 7,5 P x 10 H

- Bianco / white / blanc / weiß
- Colorato / colored / coloré / farbig
- 16 - Oro (maggiorazione)
(supplément)
(Zuschlag)

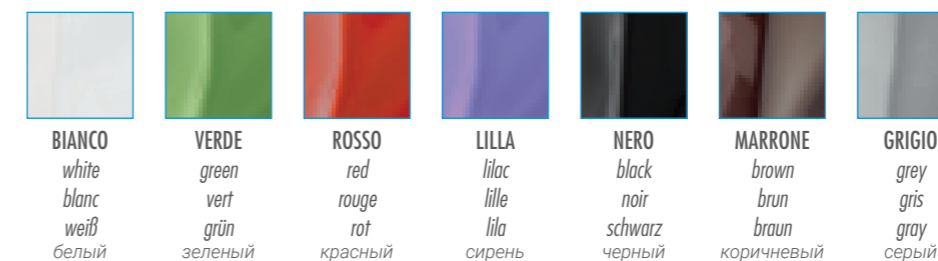

LIZ [design Massimiliano Settimelli]

Serie in ceramica
Ceramic set
Série en céramique
Serie aus Keramik
серия из керамики

LZ 09 AP

Porta sapone
Soap dish / Porte savon / Seifenschale /
мыльница
cm 13 L x 9 P x 2,5 H

- 08

LZ 10 AP

Bicchiere
Glass / Verre / Zahnputzbecher / стакан
cm Ø 8 x 11,5 H

- 08

LZ 30 AP

Dosatore sapone con pompetta in metallo
Liquid soap dispenser / Porte savon liquid /
Seifenspender / дозатор
cm Ø 8 x 17 H

- 08



BUCKET

Serie in ceramica
Ceramic set
Série en céramique
Serie aus Keramik
серия из керамики

BK 09 AP

Porta sapone
Soap dish / Porte savon / Seifenschale /
мыльница
cm Ø 12 x 3,5 H

- 08

BK 10 AP

Bicchiere
Glass / Verre / Zahnputzbecher / стакан
cm Ø 9 x 10 H

- 08

BK 30 AP

Dosatore sapone con pompetta in metallo
Liquid soap dispenser / Porte savon liquid /
Seifenspender / дозатор
cm Ø 9 x 18 H

- 08



MURANO'S [design Alessandro Lenarda]

Serie in cristallo puro

Crystal set

Série en cristal

Serie aus Kristallglas

Серия из стекла

909

Porta sapone

Soap dish / Porte savon / Seifenschale /

Настольная мыльница

cm Ø 14,5 x 4 H

- vetro / glass / verre / Glas

910

Bicchiere

Glass/Verre/Zahnputzbecher/Настольный стакан

cm Ø 11 x 9 H

- vetro / glass / verre / Glas

911

Contentitore con coperchio

Container with cover / Containeur avec couvercle /

Dose mit Deckel / Контейнер с крышкой

cm Ø 11 x 15 H

- vetro / glass / verre / Glas

912

Dosatore sapone

Liquid soap dispenser / Seifenspender /

Dose mit Deckel / настольный дозатор

cm Ø 11 x 15 H

- vetro / glass / verre / Glas

CRACLÈ

Serie in cristallo

Crystal set

Série en cristal

Serie aus Kristallglas

Серия из стекла

1124

Porta sapone

Soap dish/Porte savon/Seifenschale/

Настольная мыльница

cm Ø 13 x 3 H

- TR

- AM - AZ

1125

Bicchiere

Glass/Verre/Zahnputzbecher/Настольный стакан

cm Ø 8 x 9 H

- TR

- AM - AZ

1126

Dosatore sapone

Liquid soap dispenser/Seifenspender/

Dose mit Deckel / настольный дозатор

cm Ø 8 x 18 H

- TR

- AM - AZ



RETTANGOLO

Serie in vetro

Glass set

Série en verre

Serie aus Glas

Серия из белого стекла

1127

Porta sapone

Soap dish/Porte savon/Seifenschale/

Настольная мыльница

cm 13 L x 9 P x 3 H

- TR - SA

- NE - FU

1128

Bicchiere

Glass/Verre/Zahnputzbecher/Настольный стакан

cm 10 L x 7 P x 9 H

- TR - SA

- NE - FU

1129

Dosatore sapone

Liquid soap dispenser/Seifenspender/

Dose mit Deckel / настольный дозатор

cm 10 L x 7 P x 17 H

- TR - SA

- NE - FU

- 16 - Oro (maggiorazione)
(supplément)
(supplément)
(Zuschlag)



DIVA [design Massimiliano Settimelli]

Serie in ceramica bianca
 White ceramic set
 Série en céramique blanc
 Serie aus weißer Keramik
 серия в белой керамике

DV 09 AP

Porta sapone
 Soap dish / Porte savon / Seifenschale /
 мыльница
 cm 8 L x 12 P x 2 H

- Bianco / white / blanc / weiß

DV 10 AP

Bicchiere
 Glass / Verre / Zahnputzbecher / стакан
 cm 6 L x 9 P x 14,5 H

- Bianco / white / blanc / weiß

DV 30 AP

Dosatore sapone con pompetta in metallo
 Liquid soap dispenser / Porte savon liquid /
 Seifenspender / дозатор
 cm 6 L x 9 P x 21 H

- Bianco / white / blanc / weiß

DV 14 AP

Porta oggetti
 Storage tray / Plateau / Tablett / лоток
 cm 20 L x 10 P x 2 H

- Bianco / white / blanc / weiß



LIVING [design BGR]

Serie in ceramica bianca
 White ceramic set
 Série en céramique blanc
 Serie aus weißer Keramik
 серия в белой керамике

LV 09 AP

Porta sapone
 Soap dish / Porte savon / Seifenschale /
 мыльница
 cm 8 L x 12 P x 2 H

- Bianco / white / blanc / weiß

LV 10 AP

Bicchiere
 Glass / Verre / Zahnputzbecher / стакан
 cm 6 L x 9 P x 14,5 H

- Bianco / white / blanc / weiß

LV 30 AP

Dosatore sapone con pompetta in metallo
 Liquid soap dispenser / Porte savon liquid /
 Seifenspender / дозатор
 cm 6 L x 9 P x 21 H

- Bianco / white / blanc / weiß

- A Bianco / A white / A blanc / A weiß



CUBE

Serie in ceramica con base ottone cromato
 Ceramic set with chromed brass base
 Série en céramique avec base en laiton chromée
 Serie aus Keramik mit Fuß aus verchromtem Messing
 серия из керамики на металлической ножке

616

Porta sapone
 Soap dish / Porte savon / Seifenschale /
 мыльница
 cm 10 L x 10 P x 5 H

- 08

617

Bicchiere
 Glass / Verre / Zahnputzbecher / стакан
 cm 9 L x 9 P x 12 H

- 08

618

Dosatore sapone con pompetta in metallo
 Liquid soap dispenser / Porte savon liquid /
 Seifenspender / дозатор
 cm 10 L x 7 P x 19 H

- 08

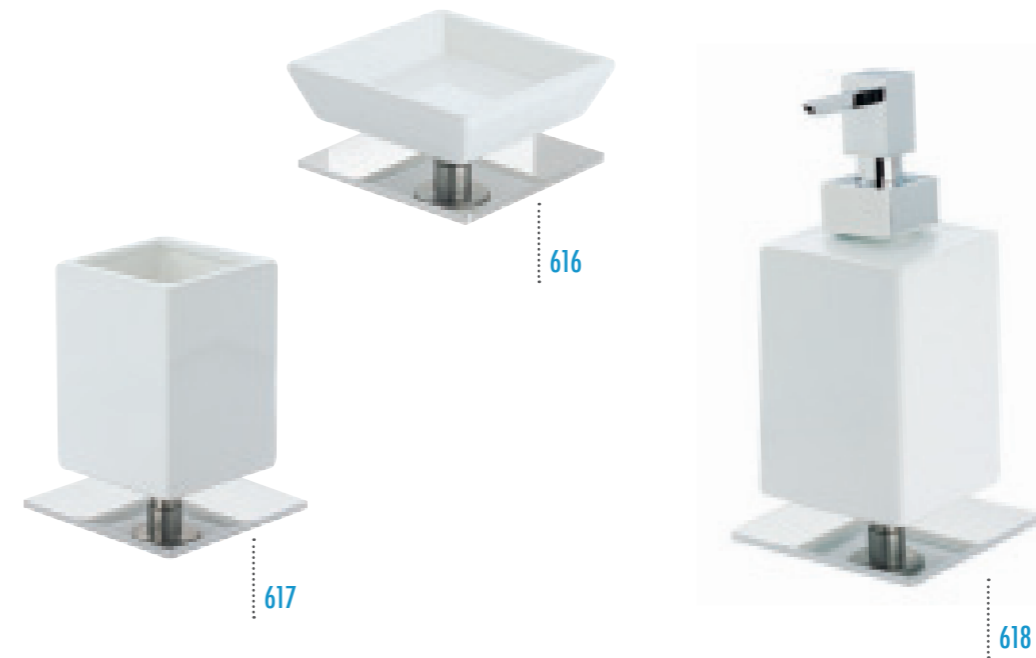

QUID [design Claudio Papa]

Serie in vetro satinato con base in ottone cromato
 Satined glass set with chromed brass base
 Série en verre opaque avec base en laiton chromée
 Serie aus satiniertem Glas mit Fuß aus
 verchromtem Messing
 серия в матовом стекле на металлической
 ножке

Q 09 AP

Porta sapone
 Soap dish / Porte savon / Seifenschale /
 мыльница
 cm 10 L x 10 P x 4 H

- 08

Q 10 AP

Bicchiere
 Glass / Verre / Zahnputzbecher / стакан
 cm 9 L x 9 P x 12 H

- 08

Q 30 AP

Dosatore sapone con pompetta in metallo
 Liquid soap dispenser / Porte savon liquid /
 Seifenspender / дозатор
 cm 9 L x 9 P x 19 H

- 08



OPERA

Serie in ceramica con base ottone cromato
 Ceramic set with chromed brass base
 Série en céramique avec base en laiton chromée
 Serie aus Keramik mit Fuß aus verchromtem Messing
 серия из керамики на металлической ножке

OP 09 AP

Porta sapone
 Soap dish / Porte savon / Seifenschale /
 мыльница
 cm Ø 12 x 5 H

- 08
- 16

OP 10 AP

Bicchieri
 Glass / Verre / Zahnputzbecher / стакан
 cm Ø 10 x 12 H

- 08
- 16

OP 30 AP

Dosatore sapone con pompetta in metallo
 Liquid soap dispenser / Porte savon liquid /
 Seifenspender / дозатор
 cm Ø 10 x 21 H

- 08
- 16



OMEGA

Serie in vetro satinato con base in ottone cromato
 Satined glass set with chromed brass base
 Série en verre opaque avec base en laiton chromée
 Serie aus satiniertem Glas mit Fuß aus
 verchromtem Messing
 серия в матовом стекле на металлической
 ножке

761

Porta sapone
 Soap dish / Porte savon / Seifenschale /
 мыльница
 cm Ø 12 x 6 H

- 08

762

Bicchieri
 Glass / Verre / Zahnputzbecher / стакан
 cm Ø 8 x 10 H

- 08

763

Dosatore sapone con pompetta in metallo
 Liquid soap dispenser / Porte savon liquid /
 Seifenspender / дозатор
 cm Ø 13 x 19 H

- 08



GLASS

Serie in vetro bianco
 White glass set
 Série en verre blanc
 Serie aus weißem Glas
 серия из белого стекла

623

Porta sapone
 Soap dish / Porte savon / Seifenschale /
 мыльница
 cm 10,5 L x 10,5 P x 2,5 H

- vetro / glass / verre / Glas / стекло

624

Bicchieri
 Glass / Verre / Zahnputzbecher / стакан
 cm 7,5 L x 7,5 P x 10 H

- vetro / glass / verre / Glas / стекло

625

Dosatore sapone con pompetta in metallo
 Liquid soap dispenser / Porte savon liquid /
 Seifenspender / дозатор
 cm 7,5 L x 7,5 P x 18 H

- vetro / glass / verre / Glas / стекло



SARA

Serie in vetro bianco o colorato
 White or coloured glass set
 Série en verre blanc ou colorée
 Serie aus weißem oder farbigem Glas
 серия из белого или цветного стекла

579

Porta sapone
 Soap dish / Porte savon / Seifenschale / мыльница
 cm Ø 12 x 2 H

- 01
- vetro colorato / colored glass / verre coloré /
farbiges Glas / витражи

578

Bicchieri
 Glass / Verre / Zahnputzbecher / стакан
 cm Ø 7 x 9 H

- 01
- vetro colorato / colored glass / verre coloré /
farbiges Glas / витражи

580

Dosatore sapone con pompetta in metallo
 Liquid soap dispenser / Porte savon liquid /
 Seifenspender / дозатор
 cm Ø 9 x 18 H

- 01
- vetro colorato / colored glass / verre coloré /
farbiges Glas / витражи



SARA colori disponibili / available colours / couleurs disponibles / verfügbare Farben

BIANCO white blanc weiß белый	VERDE green vert grün синий	ROSA pink rose rosa розовый	BLU blue bleu blau зеленый

MEDEA

Serie in ottone cromato
 Chromed brass set
 Série en laiton chromée
 Serie aus verchromtem Messing
 Серия в хроме

ME 09 M AP

Porta sapone
 Soap dish / Porte savon / Seifenschale /
 мыльница
 cm Ø 12 x 2,5 H

• 08

ME 10 AP

Bicchiere
 Glass / Verre / Zahnputzbecher / стакан
 cm Ø 6 x 11 H

• 08

ME 30 AP

Dosatore sapone con pompetta in metallo
 Liquid soap dispenser / Porte savon liquid /
 Seifenspender / Настольный дозатор
 cm Ø 6 x 16 H

• 08



URANIA

Serie in ottone cromato
 Chromed brass set
 Série en laiton chromée
 Serie aus verchromtem Messing
 серия из металла

981

Porta sapone
 Soap dish / Porte savon / Seifenschale /
 мыльница
 cm 10 L x 10 P x 1 H

• 08

982

Bicchiere
 Glass / Verre / Zahnputzbecher / стакан
 cm 6 L x 6 P x 11 H

• 08

983

Dosatore sapone con pompetta in metallo
 Liquid soap dispenser / Porte savon liquid /
 Seifenspender / дозатор
 cm 6 L x 6 P x 17 H

• 08



DIANA

Serie in ottone cromato ovale
 Oval chromed brass set
 Série en laiton chromée ovale
 Serie aus verchromtem Messing oval
 серия из металла

917

Porta sapone ovale
 Oval soap dish / Porte savon ovale / Seifenschale
 oval / овальная мыльница
 cm 14 L x 8,5 P x 2 H

• 08

918

Bicchiere ovale
 Oval glass / Verre ovale / Zahnputzbecher oval
 / овальный стакан
 cm 5,5 L x 8 P x 11 H

• 08

919

Dosatore sapone con pompetta in metallo
 Liquid soap dispenser / Porte savon liquid /
 Seifenspender / дозатор
 cm 5,5 L x 8 P x 16 H

• 08



REGAL

Serie in ottone cromato
 Chromed brass set
 Série en laiton chromée
 Serie aus verchromtem Messing
 серия в хроме

ME 09M AP

Porta sapone
 Soap dish / Porte savon / Seifenschale /
 мыльница
 cm Ø 12 x 2,5 H

• 08

1130

Bicchiere
 Glass / Verre / Zahnputzbecher / стакан
 cm Ø 6 x 11 H

• 08

1131

Dosatore sapone con pompetta in metallo
 Liquid soap dispenser / Porte savon liquid /
 Seifenspender / Настольный дозатор
 cm Ø 6 x 16 H

• 08

• 16



MARTE

Serie in vetro con base in ottone
 Glass set with brass base
 Série en verre avec base en laiton
 Serie mit Fuß aus Messing
 серия в стекле на металлической ножке

MA 09 AP

Porta sapone
 Soap dish / Porte savon / Seifenschale / мыльница
 cm 15 L x 14 P x 12 H

- 08
- 16 - 25 - 36

MA 10 AP

Bicchiere
 Glass / Verre / Zahnputzbecher / стакан
 cm 9 L x 14 P x 12 H

- 08
- 16 - 25 - 36

MA 30 AP

Dosatore sapone con pompetta in metallo
 Liquid soap dispenser / Porte savon liquid /
 Seifenspender / дозатор
 cm Ø 8 x 18 H

- 08
- 16 - 25 - 36



NOTO

Serie in vetro con base in ottone
 Glass set with brass base
 Série en verre avec base en laiton
 Serie mit Fuß aus Messing
 серия в стекле на металлической ножке

NT 09 AP

Porta sapone
 Soap dish / Porte savon / Seifenschale / мыльница
 cm Ø 12 x 5 H

- 08
- 16

NT 10 AP

Bicchiere
 Glass / Verre / Zahnputzbecher / стакан
 cm Ø 9 x 11 H

- 08
- 16

NT 30 AP

Dosatore sapone con pompetta in metallo
 Liquid soap dispenser / Porte savon liquid /
 Seifenspender / дозатор
 cm Ø 8 x 18 H

- 08
- 16



NT 10 AP

NT 09 AP

NT 30 AP

ELITE

Serie in vetro con base in ottone
 Glass set with brass base
 Série en verre avec base en laiton
 Serie mit Fuß aus Messing
 серия в стекле на металлической ножке

EL 09 AP

Porta sapone
 Soap dish / Porte savon / Seifenschale / мыльница
 cm 15 L x 14 P x 6 H

- 08
- 16 - 25 - 36

EL 10 AP

Bicchiere
 Glass / Verre / Zahnputzbecher / стакан
 cm 9 L x 14 P x 12 H

- 08
- 16 - 25 - 36

EL 30 AP

Dosatore sapone con pompetta in metallo
 Liquid soap dispenser / Porte savon liquid /
 Seifenspender / дозатор
 cm Ø 8 x 18 H

- 08
- 16 - 25 - 36



EL 10 AP

EL 09 AP

EL 30 AP

GIUNONE

Serie in ceramica bianca con base in ottone
 White ceramic set with brass base
 Série en céramique blanc avec base en laiton
 Serie aus weißer Keramik mit Fuß aus Messing
 серия из керамики на металлической ножке

G 719

Porta sapone
 Soap dish / Porte savon / Seifenschale /
 мыльница
 cm 13 L x 10 P x 11 H

- 08
- 02 - 03 - 04
- 16 - 25 - 26 - 36

G 718

Bicchiere
 Glass / Verre / Zahnputzbecher / стакан
 cm 10 L x 15 P x 15 H

- 08
- 02 - 03 - 04
- 16 - 25 - 26 - 36

G 720

Dosatore sapone con pompetta in metallo
 Liquid soap dispenser / Porte savon liquid /
 Seifenspender / дозатор
 cm Ø 12 x 18 H

- 08
- 02 - 03 - 04
- 16 - 25 - 26 - 36



Tecnica d'uso

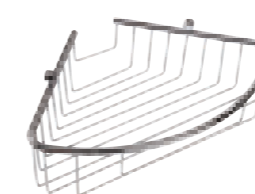

COMPLEMENTI

Designer: Stilhaus, Settimelli, Papa
Fuori misura: Si

Designer: Stilhaus, Settimelli, Papa
Customized: Yes

Designer: Stilhaus, Settimelli, Papa
Personnalis : Oui

Designer: Stilhaus, Settimelli, Papa
Kundenwunsche: Ja

Разработка дизайна: Stilhaus,
Settimelli, Papa
Негабаритный: да

771 OZIO

Porta riviste tondo universale
 Round magazine rack
 Porte journaux rond
 Zeitschriftenhalter rund universal
 Стойка под журналы
 cm 20 L x 12 P x 57 H

• 08

771/11 OZIO

Porta riviste tondo universale con portarotolo
 Round magazine rack with paper holder
 Porte journaux rond avec porte rouleau
 Zeitschriftenhalter rund universal mit Rollenhalter
 Стойка под журналы + бумагодержатель
 cm 20 L x 12 P x 57 H

• 08

772 OZIO

Porta riviste quadrato universale
 Square magazine rack
 Porte journaux cadre
 Zeitschriftenhalter eckig universal
 Стойка под журналы
 cm 20 L x 11 P x 57 H

• 08

772/11 OZIO

Porta riviste quadrato universale con portarotolo
 Square magazine rack with paper holder
 Porte journaux cadre avec porte rouleau
 Zeitschriftenhalter eckig universal mit Rollenhalter
 Стойка под журналы + бумагодержатель
 cm 20 L x 11 P x 57 H

• 08



771



771/11



772/11

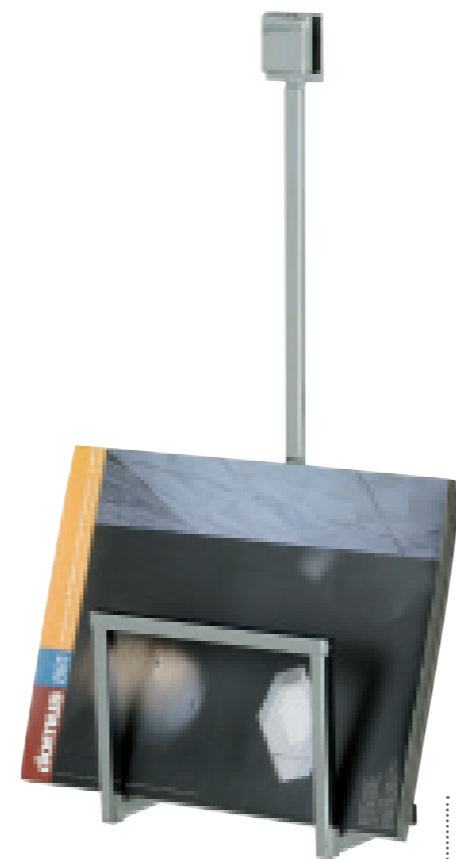

772

1056

Contentore inox
 Inox container
 Élément mural en acier
 Edelstahl-Inox
 Контейнер из нержавеющей стали
 cm 18 L x 10 P x 18 H

• 55

• 01 - 23

1057

Contentore inox
 Inox container
 Élément mural en acier
 Edelstahl-Inox

Контейнер из нержавеющей стали
 cm 36 L x 10 P x 18 H

• 55

• 01 - 23

1058

Contentore inox con porta salviette
 Inox container with towerrail
 Élément mural en acier avec porte serviettes
 Edelstahl-Inox mit Handtuchhalter
 Контейнер из нержавеющей стали с полотенцедержателем
 cm 36 L x 10 P x 28 H

• 55

• 01 - 23

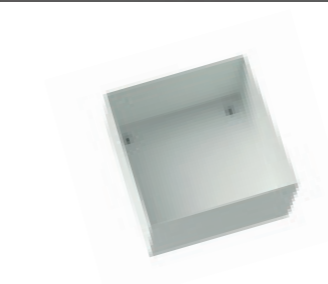

1056 01



1057 01



1058 01



1056 23



1057 23

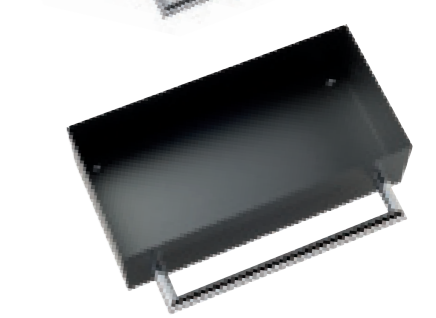

1058 23

944

Porta piastra per capelli in ottone
 Hair straightener holder in brass
 Porte lisseur à cheveux
 Halter für Haarglätter
 Латунь, дверная для волос
 cm 5 L x 13 P x 12 H

• 08



955

Porta phon in ottone
 Brass hair dryer holder
 Porte sèche-cheveux
 Föhnhalter
 Латунь, дверь Пхон
 cm 8 L x 15 P x 7 H

• 08



840

Kit collante e biadesivo per un articolo
 Kit with bi-adhesive and glue for one article
 Kit avec collant et biadhésif pour un article
 Klebekit ist ein beidseitiger Klebestreifen
 Возможность установки на клей.Ыфдгеш



1144 OTTO

Porta spazzolini elettrico
 Electric toothbrush holder
 Porte brosse à dents lectrique
 Halter für elektrische Zahnbürsten
 Держатель зубной щетки
 cm 9 L x 6 P x 5 H

• 08



1145 OTTOPLUS

Porta spazzolino elettrico
 Electric toothbrush holder
 Porte brosse à dents lectrique
 Halter für elektrische Zahnbürsten
 Держатель зубной щетки
 cm 8 L x 10 P x 9 H

• 08



840

Kit collante e biadesivo per un articolo
 Kit with bi-adhesive and glue for one article
 Kit avec collant et biadhésif pour un article
 Klebekit ist ein beidseitiger Klebestreifen
 Возможность установки на клей.Ыфдгеш



1146

Carrello 3 piani in cristallo
 3 storey glass trolley
 Chariot en verre de 3 étages
 Glasböden mit 3 glasböden
 3-х ярусная стеклянная этажерка
 cm 40 L x 30 P x 80 H

- 08
- 25 - 16



880 URANIA

Porta salviette a parete
 Wall towel holder
 Porte serviettes mural
 Handtuchhalter wandhängend
 Настенный держатель для полотенец
 cm 46 L x 90 H

- 08



554

Porta asciugamani per lavabo
 Towel rail for washbasin
 Porte serviette pour lavabo
 Handtuchhalter Waschtisch
 Полотенцедержатель под умывальник
 cm 60 L x 49 P

- 08



010 DIECI da appoggio

Positioned to floor
Freistehend
Напольный
Cm ø 8 x 41 H

- 08
- 16 - 25 - 36

010 M DIECI da parete

Positioned to wall
Wandmontage
Настенный
cm 8L x 9 P x 41 H

- 08
- 16 - 25 - 36

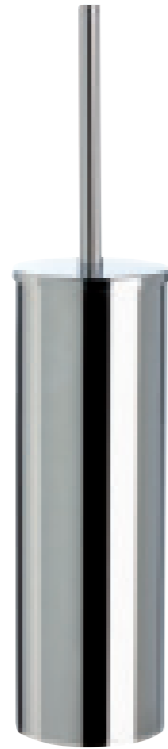

- 1 Manico e coperchio in ottone cromato
- 2 Sottocoperchio centratore con trattamento antibatterico
- 3 Ciuffo in setola intercambiabile con legatura in filo nichel-silver antiruggine con trattamento antibatterico
- 4 Contenitore interno estraibile in polipropilene con trattamento antibatterico
- 5 Cilindro esterno in ottone cromato
- 6 Base in ABS cromato appoggio soft

- 1 Handle and cover in chrome brass
- 2 Conical self-centering cover with antibacterial treatment
- 3 Bristle tuft interchangeable with nickel / silver ligature with antibacterial treatment
- 4 Removable inner part in polypropylene plastic with antibacterial treatment
- 5 Outer cylinder in chrome plated brass
- 6 Base in chromed abs, soft set down

- 1 Poignée et couvercle en laiton chromé
- 2 Centrage Innerplate avec traitement antibactérien
- 3 Touffe Bristle interchangeable avec reliure spirale rouille nickel-argent traitement antimicrobien
- 4 Récipient intérieur amovible en polypropylène avec traitement antibactérien
- 5 Cylindre externe laiton chromé
- 6 Base en ABS chrome appui douce

- 1 Stiel und Deckel aus verchromtem Messing
- 2 Zentrier-Topfschale mit antibakterieller Behandlung
- 3 Austauschbarer Bürstenkopf mit antibakterieller Behandlung
- 4 Herausnehmbarer Polypropylen-Einsatz mit antibakterieller Behandlung
- 5 Behälter aus verchromtem Messing
- 6 ABS-verchromter Soft-Touch-Fuß

- 1 Ручка и крышка из хромированной латуни
- 2 под крышкой центрирующее устройство с антибактериальное лечение
- 3 сменные насадки в переплете с никелево-серебряной антикоррозионной нитью с антибактериальное лечение
- 4 внутренний выдвигающийся контейнер из полипропилена с антибактериальное лечение
- 5 внешний цилиндр из хромированной латуни
- 6 основа из ABS

TRATTAMENTO ANTIBATTERICO

antibacterial treatment
traitement antibactérien
antibakteriell behandelt
антибактериальное лечение

TRATTAMENTO ANTIBATTERICO

antibacterial treatment
traitement antibactérien
antibakteriell behandelt
антибактериальное лечение

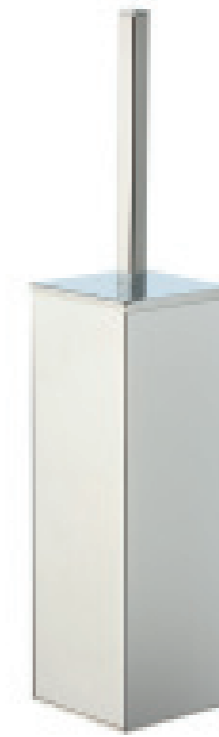

- 1 Manico e coperchio in ottone cromato
- 2 Sottocoperchio centratore con trattamento antibatterico
- 3 Ciuffo in setola intercambiabile con legatura in filo nichel-silver antiruggine con trattamento antibatterico
- 4 Contenitore interno estraibile in polipropilene con trattamento antibatterico
- 5 Cilindro esterno in ottone cromato
- 6 Base in ABS cromato appoggio soft

- 1 Handle and cover in chrome brass
- 2 Conical self-centering cover with antibacterial treatment
- 3 Bristle tuft interchangeable with nickel / silver ligature with antibacterial treatment
- 4 Removable inner part in polypropylene plastic with antibacterial treatment
- 5 Outer cylinder in chrome plated brass
- 6 Base in chromed abs, soft set down

- 1 Poignée et couvercle en laiton chromé
- 2 Centrage Innerplate avec traitement antibactérien
- 3 Touffe Bristle interchangeable avec reliure spirale rouille nickel-argent traitement antimicrobien
- 4 Récipient intérieur amovible en polypropylène avec traitement antibactérien
- 5 Cylindre externe laiton chromé
- 6 Base en ABS chrome appui douce

- 1 Stiel und Deckel aus verchromtem Messing
- 2 Zentrier-Topfschale mit antibakterieller Behandlung
- 3 Austauschbarer Bürstenkopf mit antibakterieller Behandlung
- 4 Herausnehmbarer Polypropylen-Einsatz mit antibakterieller Behandlung
- 5 Behälter aus verchromtem Messing
- 6 ABS-verchromter Soft-Touch-Fuß

- 1 Ручка и крышка из хромированной латуни
- 2 под крышкой центрирующее устройство с антибактериальное лечение
- 3 сменные насадки в переплете с никелево-серебряной антикоррозионной нитью с антибактериальное лечение
- 4 внутренний выдвигающийся контейнер из полипропилена с антибактериальное лечение
- 5 внешний цилиндр из хромированной латуни
- 6 основа из ABS



08 36 16 25

020 VENTI da appoggio

Positioned to floor
Freistehend
Напольный
cm 9,5 L x 9,5 P x 41 H

- 08
- 16 - 25 - 36

020 M VENTI da parete

Positioned to wall
Wandmontage
Настенный
cm 9,5 L x 10,5 P x 41 H

- 08
- 16 - 25 - 36

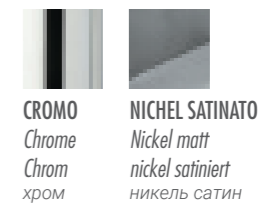

08 36

646 ZEFIRO [design Claudio Papa]

Porta scopino in ceramica da appoggio
con diffusore di profumo e una essenza profumata
*Ceramic toilet brush with scent diffuser and one
perfumed essence*

*Porte balayent en céramique d'appui avec diffuseur de
parfume et une essence parfumée*

*Bürostengarnitur aus Keramik freistehend mit
Duftspender und Duftessenz*

*Напольный керамический ёрш с
ароматизатором*

cm 13 L x 10 P x 42 H

• 08 bianco/white/blanc/weiß/белый

• 08 colorato/colored/colorée/farbig/черный



ZEFIRO colori disponibili

available colours / couleurs disponibles / verfügbare Farben / доступные цвета



BIANCO
*white / blanc /
weiß / белый*



VERDE
*green / vert /
grün / зеленый*



ROSSO
*red / rouge /
rot / красный*



ARANCIO
*orange / orangier /
orange / оранжевый*



LILLA
*lilac / lile /
lila / сирень*



NERO
*black / noir /
schwarz / черный*

così...

*Posizionato a pavimento
Positioned to floor
Position à plancher
Freistehend
Напольный*



... O COSI'

*Posizionato a parete
Positioned to wall
Position à mur
Wandmontage
Настенный*



645 COSÌ

Porta scopino in ceramica a parete e da appoggio
*Wall mounted and on floor ceramic toilet brush
Porte balayent en céramique d'appui et à mur
Bürostengarnitur aus Keramik zur Wandmontage oder
freistehend*

*Настенный и напольный
керамический ёрш*

cm 13,5 L x 22 P x 32 H

• 08

VE 039 PRATIKO

Porta scopino da appoggio con
coperchio telescopico
Toilet brush with telescopic cover
Porte balayent d'appui avec couvercle télescopique
Bürstengarnitur freistehend mit Teleskopgriff
Напольный металлический ёрш с
телескопической крышкой
cm Ø 12,5 x 54 H

- 08

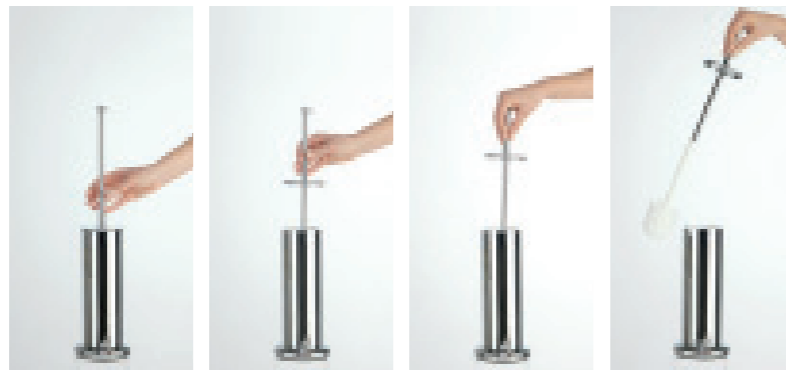

VE 039 PRATIKO

1070

Porta scopino da appoggio
Toilet brush
Porte balayent d'appui
Bürstengarnitur freistehend
Напольный металлический
cm Ø 12,5 x 54 H

- 08/bi
- 08/ne



1070 NE

1070 BI

DI 039

Porta scopino ovale in ottone da appoggio
Oval brass toilet-brush with base
Porte balayent oval en laiton d'appui
Bürstengarnitur freistehend oval aus Messing
Напольный металлический ёрш
cm 9 L x 10 P x H 38

- 08
- 36



DI 039 / DI 039 M

DI 039 M

Porta scopino ovale in ottone a parete
Wall-mounted oval brass toilet-brush
Porte balayent oval en laiton à mur
Bürstengarnitur wandhängend oval aus Messing
Настенный металлический ёрш
cm 9 L x 10 P x H 38

- 08
- 36

U 039Q URANIA

Porta scopino in ottone da appoggio
Brass toilet-brush with base
Porte balayent en laiton d'appui
Bürstengarnitur freistehend aus Messing
Напольный металлический ёрш
cm 8 L x 8 P x 41 H

- 08 - 23
- 36

URANIA



U 039Q / U 039 M

U 039M URANIA

Porta scopino quadrato in ottone a parete
Wall mounted square brass toilet-brush
Porte balayent cadre en laiton à mur
Bürstengarnitur wandhängend aus Messing
Настенный металлический ёрш
cm 8 L x 9 P x 41 H

- 08
- 36

GE 12 A

Porta scopino in ceramica da appoggio
 Ceramic toilet-brush with base
 Porte balayent en céramique d'appui
 Bürstengarnitur freistehend aus Keramik
 Напольный керамический ёрш
 cm 9 L x 9 P x 42 H

- 08

796 FAUL

Porta scopino in ceramica da appoggio
 Ceramic toilet-brush with base
 Porte balayent en céramique d'appui
 Bürstengarnitur freistehend aus Keramik
 Напольный керамический ёрш
 cm 10 L x 10 P x 38 H

- 08 bianco/white/blanc/weiß/белый
- 08 colorato/colored/colore/farbig/черный

633 CUBE

Porta scopino in ceramica da appoggio
 Ceramic toilet-brush with base
 Porte balayent en céramique d'appui
 Bürstengarnitur freistehend aus Keramik
 Напольный керамический ёрш
 cm 10 L x 10 P x 38 H

- 08
- 36

DV 12 A [design Massimiliano Settimelli]

Porta scopino in ceramica da appoggio
 Ceramic toilet brush with base
 Porte balayent en céramique d'appui
 Bürstengarnitur freistehend aus Keramik
 Напольный керамический ёрш
 cm 10 L x 10 P x 40 H

- 08

i 12 A

Porta scopino in ceramica da appoggio
 Ceramic toilet brush with base
 Porte balayent en céramique d'appui
 Bürstengarnitur freistehend aus Keramik
 Напольный керамический ёрш
 cm 13 Ø x 40 H

- 08
- 25 - 26

BK 12 [design Giovanna Talocci]

Porta scopino in ceramica
 Ceramic Toilet-brush
 Porte balayent en céramique
 Bürstengarnitur wandhängend
 Напольный керамический ёрш
 cm Ø 10 x 42 H

- 08



GE 12 A



796



CUBE

GE 12 A



DV 12 A



i 12 A



BK 12

GABRY



186



186.40

CIKO



SM 039 / SM 039 M



i 039



995 03

186 GABRY

Porta scopino in ceramica da appoggio
 Ceramic toilet brush with base
 Porte balayent en céramique d'appui
 Bürstengarnitur freistehend aus Keramik
 Напольный керамический ёрш
 cm 13 Ø x 35 H

- 02 - 08
- 39
- 40

SM 039 CIKO

Porta scopino in ottone da appoggio
 con base in PVC
 Brass toilet brush with PVC base
 Porte balayent en laiton d'appui avec base en PVC
 Bürstengarnitur aus Messing freistehend mit Sockel
 aus PVC

Напольный металлический ёрш
 cm Ø 8 x 36 H

- 08
- 02
- 16 - 25

SM 039M CIKO

Porta scopino in ottone a parete
 Wall mounted brass toilet brush
 Porte balayent en laiton à mur
 Bürstengarnitur wandhängend aus Messing
 Настенный металлический ёрш
 cm Ø 9 x 36 H

- 08
- 02
- 16 - 25

i 039

Porta scopino da appoggio con base
 Toilet brush with base
 Porte balayent d'appui
 Bürstengarnitur freistehend
 Напольный металлический ёрш
 cm 12,5 Ø x 40 H

- 08
- 16 - 25

995

Porta scopino in ABS
 ABS toilet brush
 Porte balayent en ABS
 Bürstengarnitur aus ABS
 Напольный АБС
 cm Ø 9 x 43 H

- 03

COMPLEMENTI

076

Asta per tenda doccia
 Brass support bar for tent
 Barre de supporte en laiton pour tende
 Stange aus Messing für Duschvorhang
 Угловая перекалдина для занавесок в ванную
 cm 80 L x 80 P x Ø 2

- 08
- 25 - 16

Si realizzano misure personalizzate / We realize personalized measure / Nous réalisons des mesures personnalisées / Die Stangen können nach Maß gefertigt werden / Можно производить под размер



076

082

Asta per tenda vasca con rompi tratta
 Brass support bar for tent
 Barre de supporte en laiton pour tende
 Stange aus Messing für Duschvorhang
 Угловая перекалдина для занавесок в ванную
 cm 170 L x 80 P x Ø 2

- 08
- 25 - 16



082

078

Asta curva per tenda doccia
 Brass curved support bar for tent
 Barre de supporte courbe en laiton pour tende
 Stange rund aus Messing für Duschvorhang
 Полукруглая перекалдина для занавесок в ванную
 cm 80 L x 80 P x Ø 2 R 55

- 08
- 25 - 16



078

079

Asta per tenda doccia
 Brass support bar for tent
 Barre de supporte en laiton pour tende
 Stange aus Messing für Duschvorhang
 Полукруглая перекалдина для занавесок в ванную
 cm 88/90 L x Ø 2

- 08
- 25 - 16



079



ORO
 Gold
 Gold
 золото

BRONZO
 Bronze
 Bronze
 Бронза

16 25



080

Supporto in ottone per tenda doccia
 Brass support for tent
 Supporte en laiton pour tende
 Aufhängung aus Messing für Duschvorhang
 Круглая перекалдина для занавесок в ванную
 cm 80 Ø x 84 P x 10 H

- 08
- 25 - 16



080

081

Ganci per tenda doccia
 Curtain hooks for tent
 Crochets de rideau pour tende
 Vorhanghaken
 Крючок для занавесок
 cm 3 L x 6 H

- 08

8 pz x tenda / tent / tende / Vorhang / палатка cm 120 L
 12 pz x tenda / tent / tende / Vorhang / палатка cm 180 L
 16 pz x tenda / tent / tende / Vorhang / палатка cm 240 L



083



081

083

Ganci per tenda doccia
 Curtain hooks for tent
 Crochets de rideau pour tende
 Vorhanghaken
 Крючок для занавесок
 cm 3 L x 6 H

- 55

8 pz x tenda / tent / tende / Vorhang / палатка cm 120 L
 12 pz x tenda / tent / tende / Vorhang / палатка cm 180 L
 16 pz x tenda / tent / tende / Vorhang / палатка cm 240 L

077

Supporto in ottone per tenda doccia ad ombrello
 Brass support for tent to umbrella shape
 Supporte en laiton pour tende à parapluie
 Fächerförmige Aufhängung aus Messing für Duschvorhang
 Перекалдина для шторок зонтиком
 cm 75 P - apertura 120°

- 08



077



075

Tenda doccia in tessuto di poliestere plastificato
 Polyester material shower tent
 Tende douche dans tissu de polyester
 Duschvorhang Textil aus Polyester
 Душевая занавеска из полиэстера

- 075.00 cm 120 L x 200 H
- 075.01 cm 180 L x 200 H
- 075.02 cm 240 L x 200 H

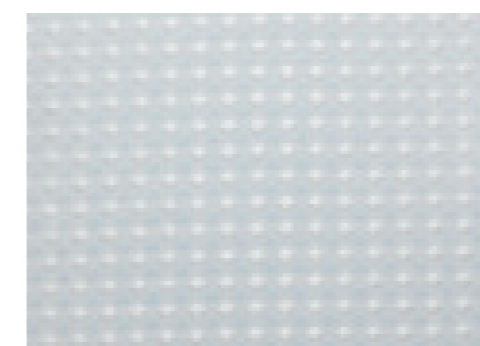

075 NIDO D'APE BIANCO

Tenda doccia in tessuto di poliestere plastificato
 Polyester material shower tent
 Tende douche dans tissu de polyester
 Duschvorhang Textil aus Polyester
 Душевая занавеска из полиэстера

- 075.01 APBI cm 180 L x 200 H

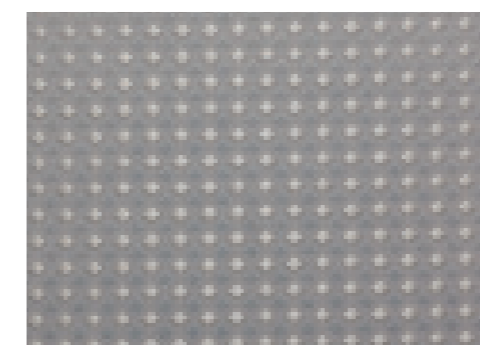

075 NIDO D'APE ECRÙ

Tenda doccia in tessuto di poliestere plastificato
 Polyester material shower tent
 Tende douche dans tissu de polyester
 Duschvorhang Textil aus Polyester
 Душевая занавеска из полиэстера

- 075.01 APEC cm 180 L x 200 H



075 CRASH BIANCO

Tenda doccia in tessuto di poliestere plastificato
 Polyester material shower tent
 Tende douche dans tissu de polyester
 Duschvorhang Textil aus Polyester
 Душевая занавеска из полиэстера

- 075.01 CRBI cm 180 L x 200 H

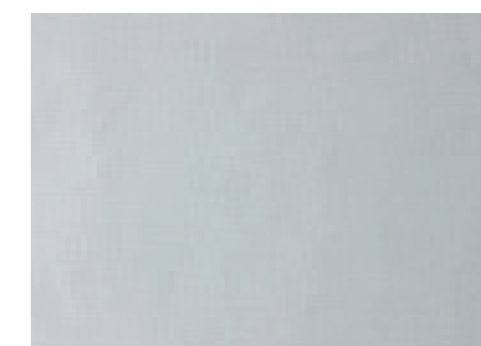

075 LINEUM BIANCO

Tenda doccia in tessuto di poliestere plastificato
 Polyester material shower tent
 Tende douche dans tissu de polyester
 Duschvorhang Textil aus Polyester
 Душевая занавеска из полиэстера

- 075.01 LMBI cm 180 L x 200 H

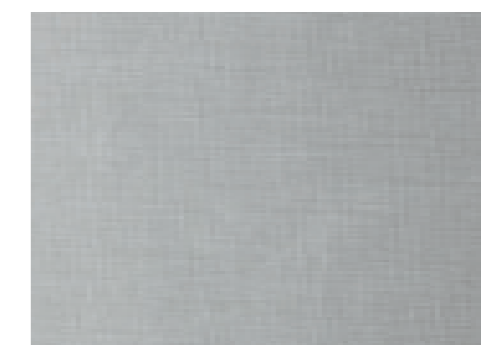

075 LINEUM ECRÙ

Tenda doccia in tessuto di poliestere plastificato
 Polyester material shower tent
 Tende douche dans tissu de polyester
 Duschvorhang Textil aus Polyester
 Душевая занавеска из полиэстера

- 075.01 LMEC cm 1180L x 200 H

1152

Maniglione di sicurezza in ottone ad angolo
 Brass emergency handle
 Poignée de sûreté en laiton
 Bad Sicherheitsgriff aus Messing
 Поручень
 cm 40 L x 10 P x 18 H x Ø 3

- 08
- 16 - 25

1153

Maniglione di sicurezza in ottone
 Brass emergency handle
 Poignée de sûreté en laiton
 Bad Sicherheitsgriff aus Messing
 Поручень
 cm 35 L x 9 P x 6 H x Ø 3

- 08
- 16 - 25

1154

Maniglione di sicurezza in ottone
 Brass emergency handle
 Poignée de sûreté en laiton
 Bad Sicherheitsgriff aus Messing
 Поручень
 cm 45 L x 9 P x 6 H x Ø 3

- 08
- 16 - 25

1155

Maniglione di sicurezza in ottone
 Brass emergency handle
 Poignée de sûreté en laiton
 Bad Sicherheitsgriff aus Messing
 Поручень
 cm 60 L x 9 P x 6 H x Ø 3



- 08
- 16 - 25

1156

Maniglione di sicurezza in ottone
 Brass emergency handle
 Poignée de sûreté en laiton
 Bad Sicherheitsgriff aus Messing
 Поручень
 cm 80 L x 9 P x 6 H x Ø 3

- 08
- 16 - 25



	
ORO	BRONZO
Gold	Bronze
Gold	Bronze
золото	Бронза

16 25



1147

Maniglione di sicurezza in ottone ad angolo
 Brass emergency handle
 Poignée de sûreté en laiton
 Bad Sicherheitsgriff aus Messing
 Поручень
 cm 40 L x 10 P x 18 H x Ø 3

- 08
- 36

1148

Maniglione di sicurezza in ottone
 Brass emergency handle
 Poignée de sûreté en laiton
 Bad Sicherheitsgriff aus Messing
 Поручень
 cm 35 L x 9 P x 6 H x Ø 3

- 08
- 36

1149

Maniglione di sicurezza in ottone
 Brass emergency handle
 Poignée de sûreté en laiton
 Bad Sicherheitsgriff aus Messing
 Поручень
 cm 45 L x 9 P x 6 H x Ø 3

- 08
- 36

1150

Maniglione di sicurezza in ottone
 Brass emergency handle
 Poignée de sûreté en laiton
 Bad Sicherheitsgriff aus Messing
 Поручень
 cm 60 L x 9 P x 6 H x Ø 3

- 08
- 36

1151

Maniglione di sicurezza in ottone
 Brass emergency handle
 Poignée de sûreté en laiton
 Bad Sicherheitsgriff aus Messing
 Поручень
 cm 80 L x 9 P x 6 H x Ø 3

- 08
- 36



1147

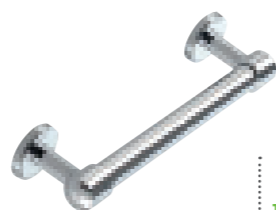

1148



1149



1150



1151

 NICHEL SATINATO
 Satin nickel
 Nickel satiné
 Nickel matt
 Никель сатин

36



233

Maniglione di sicurezza in ottone ad angolo
 Brass emergency handle
 Poignée de sûreté en laiton
 Bad Sicherheitsgriff aus Messing
 Поручень
 cm 40 L x 10 P x 18 H x ø 2

- 08
- 16 - 25

884

Maniglione di sicurezza in ottone con griglia
 Brass emergency handle with rack
 Poignée de sûreté en laiton avec grille
 Bad Sicherheitsgriff mit Seifenkorb
 Поручень + решетка
 cm 39 L x 13 P x 19 H x ø 2

- 08
- 16 - 25

885

Maniglione di sicurezza in ottone
 Brass emergency handle
 Poignée de sûreté en laiton
 Bad Sicherheitsgriff
 Поручень
 cm 34 L x 10 P x 5 H x ø 2

- 08
- 16 - 25

886

Maniglione di sicurezza in ottone
 Brass emergency handle
 Poignée de sûreté en laiton
 Bad Sicherheitsgriff
 Поручень
 cm 45 L x 10 P x 5 H x ø 2

- 08
- 16 - 25

887

Maniglione di sicurezza in ottone
 Brass emergency handle
 Poignée de sûreté en laiton
 Bad Sicherheitsgriff
 Поручень
 cm 64 L x 10 P x 5 H x ø 2

- 08
- 16 - 25

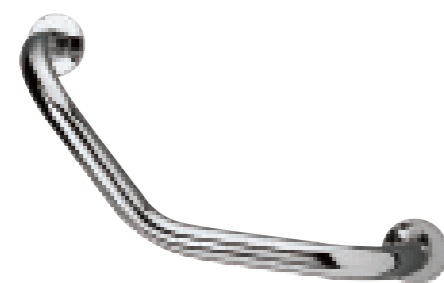

233



884



885



886



887

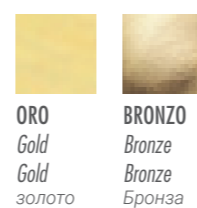

16 25



640/926



649/642



641/770/922

640/926

Pedana quadrata per doccia in multistrato marino
 Square marine multilayer footrest for shower
 Estrade cadre pour douche en multicouche marine
 Fußpodest für Dusche quadratisch in Schichtholz
 Квадратный поддон из дерева

- 926 cm 50 L x 50 P
- 640 cm 60 L x 60 P

641/770/922

Pedana rettangolare per doccia in multistrato marino
 Rectangular marine multilayer footrest for shower
 Estrade rectangulaire pour douche en multicouche marine
 Fußpodest für Dusche rechteckig in Schichtholz
 Прямоугольный поддон из дерева

- 641 cm 54 L x 69 P
- 770 cm 56 L x 79 P
- 922 cm 57 L x 96 P

642

Pedana semicircolare per doccia in multistrato marino
 Semicircular marine multilayer footrest for shower
 Estrade semi-circulaire pour douche en multicouche marine
 Fußpodest für Dusche halbrund in Schichtholz
 Поддон угловой из дерева
 cm 61 L x 61 P

649

Pedana semicircolare per doccia in multistrato marino
 Semicircular marine multilayer footrest for shower
 Estrade semi-circulaire pour douche en multicouche marine
 Fußpodest für Dusche halbrund in Schichtholz
 Поддон угловой из дерева
 cm 73,5 L x 73,5 P



036

Sedile per doccia con seduta in legno
 Seat for shower with wood sitting
 Siège pour douche avec séance en bois
 Duschsitz in Holz
 Сиденье в душевой угол из дерев
 cm 35 L x 37 P

• 01

Kg 100 Carico statico
 Static load/Charge statique/Statische Belastung



036

643

Sedile doccia, alluminio e polipropilene
 Aluminum and polypropylene seat for shower
 Siège pour douche, aluminium et polypropylène
 Duschsitz in Aluminium und Polypropylen
 Сиденье в душевой угол
 cm 12/47 P x 42 L

• 01

Kg 110 Carico statico
 Static load/Charge statique/Statische Belastung
 CE norma MDD 93/42



643

869 COMODO

Sedile doccia in acciaio e plexiglass
 Steel and plexiglass seat for shower
 Siège pour douche en acier et plexiglass
 Duschsitz in Stahl und Plexiglas
 Сиденье в душевой угол
 cm 33 L x 7/34 P x 10/34 H

• 54

Kg 160 Carico statico
 Static load/Charge statique/Statische Belastung

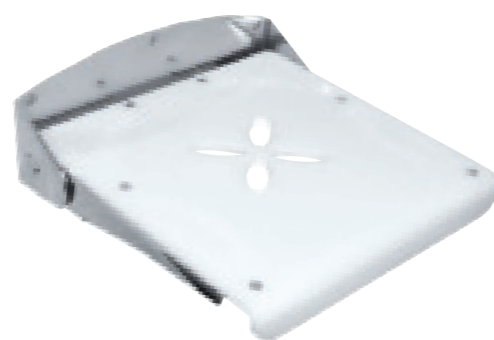

869
 COMODO [design Massimiliano Settimelli]

754

Sedile per vasca con seduta in polipropilene,
 regolabile
 Adjustable seat for bath-tub with polypropylene sitting
 Siège pour baignoire avec séance réglable en
 polypropylène
 Badewannensitz aus Polypropylen, verstellbar
 Сиденье для ванны регулируемое
 cm 65/72 L x 38 P x 27 H

• 01

Kg 110 Carico statico
 Static load/Charge statique/Statische Belastung
 CE norma MDD 93/42



754

033.01

Sedile per vasca con seduta in plastica
 Seat for bath-tub with plastic sitting
 Siège pour baignoire avec séance en plastique
 Badewannensitz aus Kunststoff
 Сиденье для ванны
 cm 65/70 L x 28 P x 18 H

• 01

Kg 80 Carico statico
 Static load/Charge statique/Statische Belastung



033.01

1085 - SEDILE DOCCIA

Sedile doccia in acciaio e plexiglass
 Steel and plexiglass seat for shower
 Siège pour douche en acier et plexiglass
 Duschsitz aus Stahl und Plexiglas
 Сиденье в душевой угол
 cm 32 L x 7/33 P x 33/7 H

• 55

Kg 160 Carico statico
 Static load/Charge statique/Statische Belastung



839

Pulisci vetri con supporto, ad incollo
 Shower door wiper, with glue
 Nettoyeur de douche, pour coller
 Glaswischer mit Wandhalterung aus verchromtem
 Messing zum Kleben
 Стёклоочиститель
 cm 24 L x 5 P x 19 H

• 08



839

1078

Pulisci vetri con porta accappatoio singolo
 Shower door wiper
 Nettoyeur de douche
 Glaswischer mit Wandhalterung
 Messing zum Kleben
 Стёклоочиститель
 cm 24 L x 5 P x 19 H

• 08



1078

964

Gancio porta accappatoio corto
 Robe hook
 Porte peignoir
 Bademantelhaken
 Крючок
 cm 2 L x 5 P x 12 H

• 08



964

965

965

Gancio porta accappatoio lungo
 Robe hook
 Porte peignoir
 Bademantelhaken
 Крючок
 cm 2 L x 5 P x 15 H

• 08



965

984

Porta accappatoio singolo
 Robe hook
 Porte peignoir
 Bademantelhaken
 Крючок
 cm 6 L x 8 P x 2 H

• 08

• 16-25

985

Porta accappatoio doppio
 Robe hook
 Porte peignoir
 Bademantelhaken
 Крючок
 cm 10 L x 8 P x 2 H

• 08

• 16-25



985

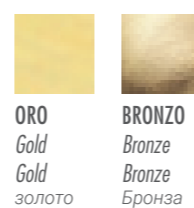

ORO
 Gold
 Gold
 золото

BRONZO
 Bronze
 Bronze
 Бронза

16

25

1119

Griglia porta spugna in ottone
 Brass grill sponge holder
 Grille porte éponge en laiton
 Korbgestell, Schwammhalter aus Messing
 Решётка в ванную
 cm 45 L x 10 P x 8 H

• 08

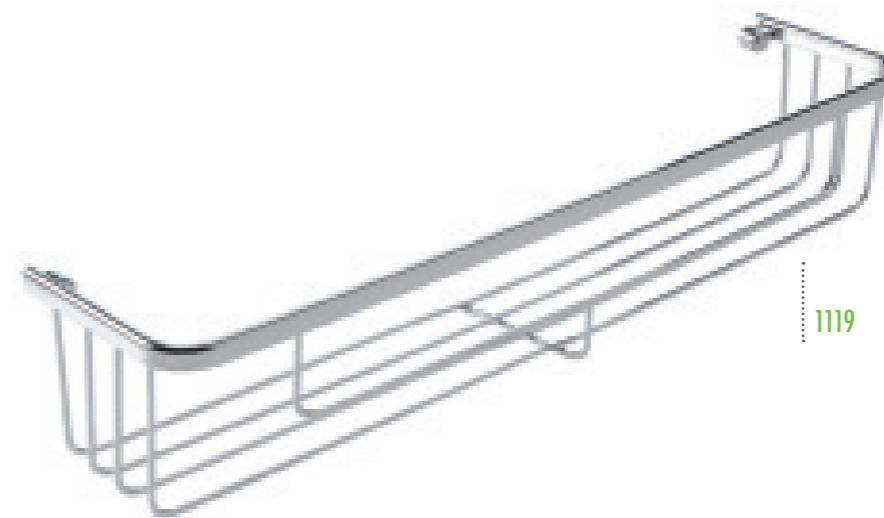

1119

1120

Griglia porta spugna in ottone
 Brass grill sponge holder
 Grille porte éponge en laiton
 Korbgestell, Schwammhalter aus Messing
 Решётка в ванную
 cm 30,5 L x 10 P x 8 H

• 08

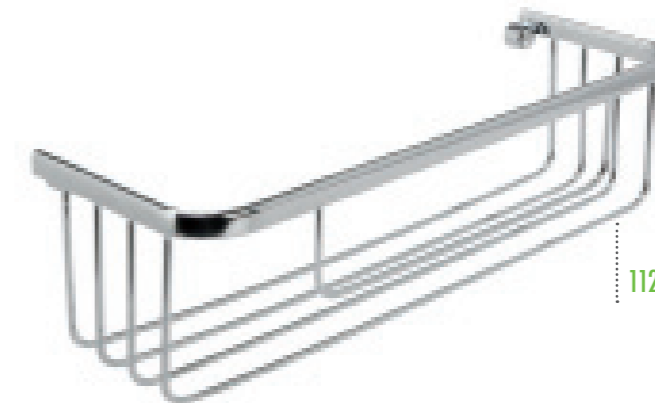

1120

1121 DX

Griglia porta spugna in ottone ad angolo
 Brass grill sponge holder
 Grille porte éponge en laiton
 Korbgestell, Schwammhalter aus Messing
 полка угловая с ограничителем правая/левая
 cm 25 L x 16 P x 8 H

• 08 dx

• 08 sx

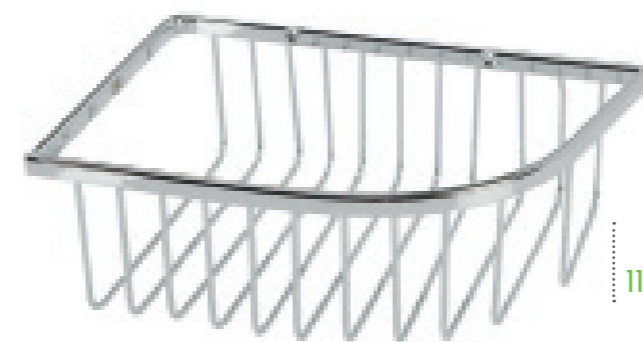

1121 DX

1099

Griglia porta spugna pensile in ottone
 Brass grill sponge holder
 Grille porte éponge en laiton
 Korbgestell, Schwammhalter aus Messing
 Решётка в ванную
 cm 25 L x 12 P x 35 H

• 08

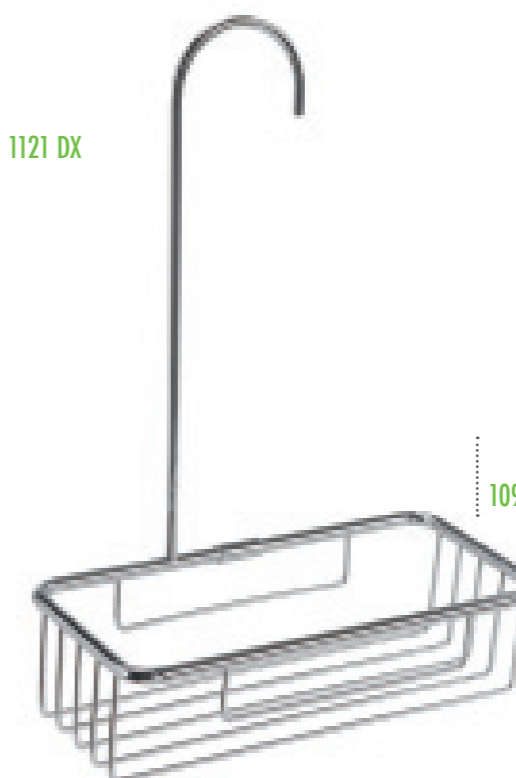

1099

1087

Mensola in plexiglass ad angolo con balconcino
 Shelf with plexyglass planeand balcony
 Console avec plateau en Plexyglas et balconnet
 Ablage aus klarem plexiglass mit Halteleiste
 полка из оргстекла с ограничителем
 cm 20 L x 20 P x 12,5 H

• 08



1087

1088

Mensola ad angolo con balconcino DX + SX
 Shelf with plexyglass planeand balcony
 Console avec plateau en plexyglass et balconnet
 Ablage aus klarem Plexyglas mit Halteleiste
 полка угловая с ограничителем правая/левая
 cm 25 L x 16 P x 12,5 H

• 08



1088

1089

Mensola in plexiglass con balconcino
 Shelf with plexyglass planeand balcony
 Console avec plateau en plexyglass et balconnet
 Ablage aus klarem Plexyglas mit Halteleiste
 полка из оргстекла с ограничителем
 cm 26 L x 11 P x 12,5 H

• 08



1089

1090

Mensola in plexiglass con balconcino
 Shelf with plexyglass planeand balcony
 Console avec plateau en Plexyglas et balconnet
 Ablage aus klarem Plexiglass mit Halteleiste
 полка из оргстекла с ограничителем
 cm 40 L x 11 P x 12,5 H

• 08



1090

1046

Pensile doccia a parete
 Double shelf for wall
 Structure a mur avec 2 plateaux
 Korbgestell, 2 Ablagen
 Решётка в ванную 2-х уровневая
 cm 26 L x 11 P x 52 H

• 08



1046

1044

Pensile doccia per pannello fisso
 Double shelf for glass shower
 Structure avec 2 plateaux et 2 porte peignoir
 Korbgestell mit 2 Ablagen, 2 Haken
 Решётка 2-х + 2 крючка для душевого угла
 cm 26 L x 11 P x 55 H

• 08

1045

Pensile doccia per box con ante scorrevole
 Double shelf for glass shower with sliding doors
 Structure avec 2 plateaux et porte peignoir
 Korbgestell für Dusche mit Schiebetüren,
 rechteckig, mit 2 Haken für Bademäntel
 Решётка 2-х + 2 крючка для душевого угла
 cm 26 L x 11 P x 56 H

• 08

Per ante scorrevoli

For sliding doors

Pour porte coulissantes

Für Schiebetüren

Раздвижных дверей



1044



1045

872

Griglia porta spugna in ottone
 Brass grill sponge holder
 Grille porte éponge en laiton
 Korbgestell, Schwammhalter aus Messing
 Решётка в ванную
 cm 28,5 L x 12,5 P x 7 H

• 08

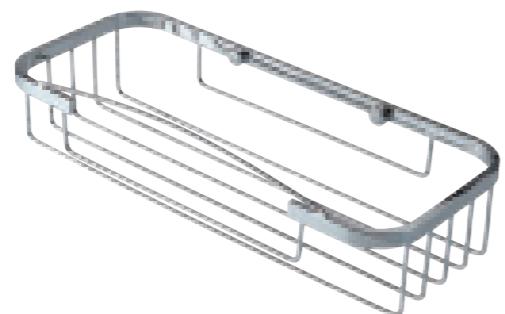

872

873

Griglia porta spugna in ottone
 Brass grill sponge holder
 Grille porte éponge en laiton
 Korbgestell, Schwammhalter aus Messing
 Решётка в ванную
 cm 40 L x 12,5 P x 7 H

• 08

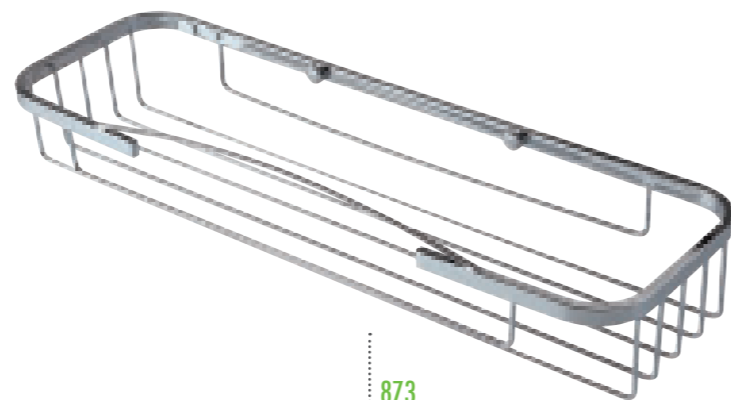

873

875

Griglia angolare in ottone per doccia
 Brass corner grill for shower
 Grille angulaire en laiton pour douche
 Korbgestell eckig aus Messing für Dusche
 Решётка в ванную
 cm 29 L x 20 P x 6 H

• 08



875

874

Griglia angolare in ottone per doccia
 Brass corner grill for shower
 Grille angulaire en laiton pour douche
 Korbgestell eckig aus Messing für Dusche
 Решётка в ванную
 cm 26 L x 18 P x 6 H

• 08



874

1071

Griglia porta spugna in ottone
 Brass grill sponge holder
 Grille porte éponge en laiton
 Korbgestell, Schwammhalter aus Messing
 Решётка в ванную
 cm 34 L x 13,5 P x 7 H

• 08



1071

 Possibilità di fissaggio ad incollo
 Possibility of installation by glue
 Possibilité de fixation par colle
 Befestigungsmöglichkeit mit Klebstoff
 Возможность крепления на клей

1072

Pensile doccia rettangolare con
 1 piano e 2 porta accappatoio
 Rectangular structure for shower with
 1 shelf and 2 robe-hook
 Structure rectangulaire avec 1
 plateaux et 2 porte peignoir
 Korbgestell rechteckig mit 1 Ablagen, 2 Haken
 Решётка 1-х уровневая + 2 крючка для
 душевого угла
 cm 31 L x 13,5 P x 35 H

• 08



1072

840

Kit collante e biadesivo per un articolo
 Kit with bi-adhesive and glue for one article
 Kit avec collant et biadhésif pour un article
 Klebekit ist ein beidseitiger Klebestreifen
 Возможность установки на клей.Ыфдгеш



COMPLEMENTI

571

Griglia angolare in ottone per doccia
 Brass corner grill for shower
 Grille angulaire en laiton pour douche
 Korbgestell eckig aus Messing für Dusche
 Решётка в ванную
 cm 21 L x 18 P x 5 H

- 08
- 16 - 25



570 dx



571 dx

570

Griglia angolare in ottone con 2 ripiani
 Brass corner grill with 2 shelves
 Grille angulaire en laiton avec 2 plateaux
 Korbgestell eckig aus Messing mit 2 Ablagen
 Решётка в ванную 2-х уровневая
 cm 20 L x 12 P x 29 H

- 08
- 16 - 25

569

Griglia angolare in ottone con 3 ripiani
 Brass corner grill with 3 shelves
 Grille angulaire en laiton avec 3 plateaux
 Korbgestell eckig aus Messing mit 3 Ablagen
 Решётка в ванную 3-х уровневая
 cm 20 L x 12 P x 54 H

- 08
- 16 - 25

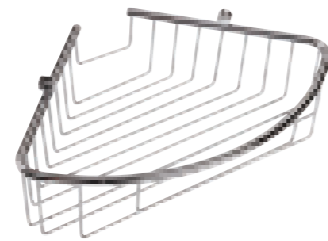

952

952

Griglia angolare in ottone
 Brass corner grill
 Grille angulaire en laiton
 Korbgestell eckig aus Messing
 Решётка в ванную
 cm 29 L x 20 P x 7 H

- 08



879

879

Griglia angolare in ottone con 2 ripiani
 Brass corner grill with 2 shelves
 Grille angulaire en laiton avec 2 plateaux
 Korbgestell eckig aus Messing mit 2 Ablagen
 Решётка в ванную 2-х уровневая
 cm 30 L x 20 P x 34 H

- 08



569

1007

Placca per incollo con colla
 Metal part for fixing with glue
 Plaque métallique pour fixation avec colle
 Blech eckig für zum Kleben links
 Крепеж на клей
 cm 10 L x 1 P x 6 H



- 1007 per griglia doppia



1007

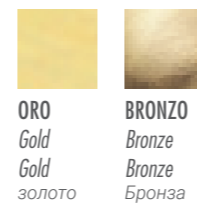

ORO
 Gold
 Gold
 золото

BRONZO
 Bronze
 Bronze
 Бронза

16 25



570

D15

Griglia porta spugna in ottone
 Brass grill sponge holder
 Grille porte éponge en laiton
 Korbgestell, Schwammhalter aus Messing
 Решётка в ванную

cm 25 L x 12 P x 8 H

- 08
- 16 - 25

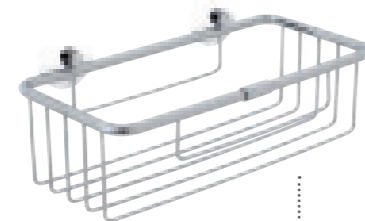

D 15

868

Griglia angolare per doccia
 Brass grill for shower
 Grille angulaire
 Korbgestell eckig für Dusche
 Решётка в ванную

cm 27 L x 27 P x 7 H

- 08



868

785

Pensile doccia rettangolare con 2 piani e 2 porta cappatoio
 Rectangular structure for shower with 2 shelves and 2 robe-hook
 Structure rectangulaire avec 2 plateaux et 2 porte peignoir
 Korbgestell rechteckig mit 2 Ablagen, 2 Haken
 Решётка 2-х уровневая + 2 крючка для душевого угла

cm 25 L x 12P x 53 H

- 08



785

822

Griglia rettangolare con 2 piani per doccia
 Brass rectangular grill, 2 shelves for shower
 Grille rectangulaire eulaiton avec 2 plateaux
 Korbgestell rechteckig aus Messing, 2 Ablagen
 Решётка в ванную 2-х уровневая

cm 25 L x 12 P x 52 H

- 08



822

988

Griglia rettangolare per vasca
 Brass rectangular grill for bathtub
 Grille rectangulaire en laiton pour baignoire
 Korbgestell rechteckig aus Messing für Badewanne
 Решётка в ванную для ванна

cm 16 L x 71/80 P x 8 H

- 08

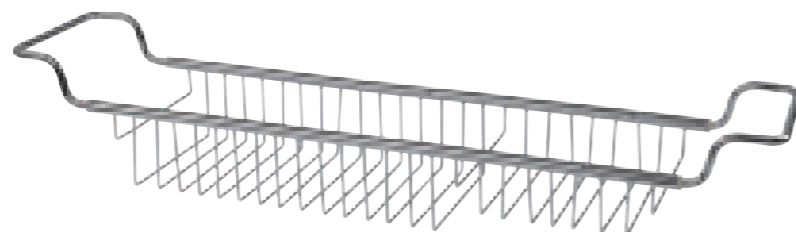

988

1007

Placca per incollo con colla
 Metal part for fixing with glue
 Plaque métallique pour fixation avec colle
 Blech eckig für zum Klebem links
 Крепеж на клей

cm 10 L x 1 P x 6 H

- 1007 per griglia doppia



1007

773

Pensile doccia rettangolare adatto a box doccia con ante scorrevole, con 2 porta cappatoio
 Rectangular structure for shower with 2 shelves and robe-hook
 Structure rectangulaire avec 2 plateaux et porte peignoir
 Korbgestell für Dusche mit Schiebetüren, rechteckig, mit 2 Haken für Bademäntel
 Решётка 2-х уровневая + крючок для душевого угла

cm 26 L x 55 H - P int. 12

- 08

Foto: versione sinistra
 Photo: left version
 Photo: version gauche
 Auf dem Bild: linke Ausführung
 Фото: Левый версия



L'unico per ante scorrevoli

The only one for sliding doors

Le seul pour porte coulissantes

: Das einzige Korbgestell für Duschen mit Schiebetüren

Только для раздвижных дверей

Brevetto Europeo N. 272623
 European Patent No. 272623
 Brevet Européen No. 272623
 Europäisches Patent Nr. 272623
 Европейский патент № 272 623

048

Struttura angolare sospesa in ottone con due ripiani in Vedril e 2 ganci

Wall mounted corner brass structure with 2 Vedril shelves and 2 hooks

Structure à angle suspendue en laiton avec 2 plateaux en Vedril et 2 crochets

Gestell eckig aus Messing mit 2 Ablagen aus Vedril und 2 Haken

Решётка 2-х уровневая + 2 крючка в ванную

cm 22 L x 13 P x 40 H

• 08



048

844

Mensola da 8 mm con balconcino

Shelf 8 mm with balcony

Console de 8 mm et balconnet

Ablage aus 8 mm mit Halteleiste

Стеклянная полка с ограждением - толщина стекла 8 мм

cm 35 L x 25 P x 5 H

• 08

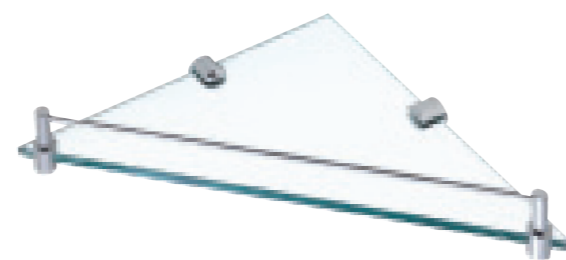

844

G 693 GIUNONE

Angolare in ottone con 3 ripiani in Vedril

Wall mounted corner brass with 3 Vedril shelves

Angulaire en laiton avec 3 plateaux en Vedril

Gestell eckig aus Messing mit 3 Ablagen aus Vedril

Решётка 3-х уровневая в ванную

cm 22 L x 13 P x 45 H

• 08

• 02 - 03 - 04

• 16 - 25 - 26 - 36



G 693

EL 31 ELITE

Angolare in ottone con 3 ripiani in Vedril

Wall mounted corner brass with 3 Vedril shelves

Angulaire en laiton avec 3 plateaux en Vedril

Gestell eckig aus Messing mit 3 Ablagen aus Vedril

Решётка 3-х уровневая в ванную

cm 22 L x 13 P x 45 H

• 08

• 02

• 16 - 25 - 26 - 36



EL 31



EL 31

COMPLEMENTI

EL 694 ELITE

Struttura rettangolare sospesa in ottone con 2 ripiani in cristallo 5 mm
 Wall mounted rectangular brass structure with 2 crystal glass shelves 5 mm
 Structure rectangulaire suspendue en laiton avec 2 plateaux en cristal 5 mm
 Gestell rechteckig aus Messing mit 2 Ablagen aus Kristallglas 5 mm
 Стеклопанельная полка 2-х уровневая с ограждением
cm 45 L x 15 P x 38 H

- 08
- 02 - 03 - 04
- 16 - 25 - 26 - 36



EL 694

G 694 GIUNONE

Struttura rettangolare sospesa in ottone con 2 ripiani in cristallo 5 mm
 Wall mounted rectangular brass structure with 2 crystal glass shelves 5 mm
 Structure rectangulaire suspendue en laiton avec 2 plateaux en cristal 5 mm
 Gestell rechteckig aus Messing mit 2 Ablagen aus Kristallglas 5 mm
 Стеклопанельная полка 2-ух уровневая с ограждением
cm 45 L x 15 P x 38 H

- 08
- 02 - 03 - 04
- 16 - 25 - 26 - 36



G 694

Z 04

Mensola da 8mm
 Shelf 8mm
 Console 8mm
 Ablage 8 mm
 Стеклопанельная полка - толщина стекла 8 мм
cm 60 L x 12 P x 2 H

- 08

Su misura 
 on measure / sur mesure / maßgeschneiderte / настроили

- 08 - cm 30/59
- 08 - cm 61/100

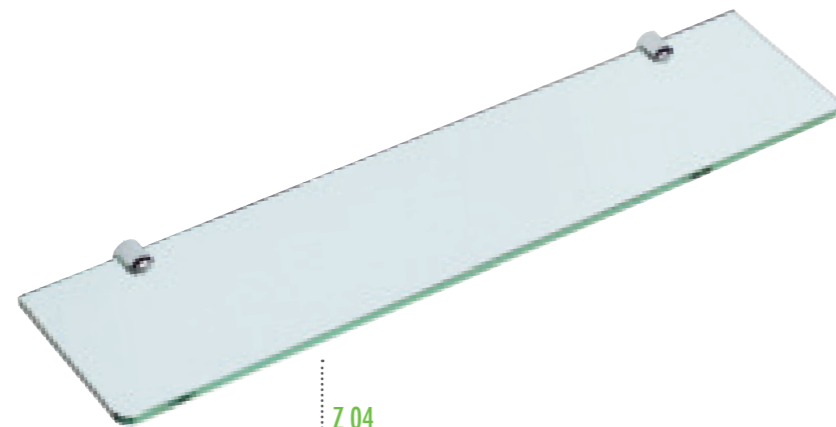

Z 04



766 SMART

Mensola da 8 mm e balconcino
 Shelf with 8 mm crystal glass plane and balcony
 Console avec plateau en cristal de 8 mm et balconnet
 Ablage aus klarem Kristallglas 8 mm mit Halteleiste
 Стеклопанельная полка с ограждением - толщина стекла 8 мм

- 08 - cm 40 L x 14 P x 7 H
- 08 - cm 30 L x 14 P x 7 H



819 MEDEA

Mensola da 8 mm con balconcino
 Shelf with 8 mm crystal glass plane and balcony
 Console avec plateau en cristal de 8 mm et balconnet
 Ablage aus klarem Kristallglas 8 mm mit Halteleiste
 Стеклопанельная полка с ограждением - толщина стекла 8 мм

- 08 - cm 40 L x 14 P x 7 H
- 08 - cm 30 L x 14 P x 7 H



820 URANIA

Mensola da 8 mm con balconcino
 Shelf with 8 mm crystal glass plane and balcony
 Console avec plateau en cristal de 8 mm et balconnet
 Ablage aus klarem Kristallglas 8 mm mit Halteleiste
 Стеклопанельная полка с ограждением - толщина стекла 8 мм

- 08 - cm 40 L x 14 P x 7 H
- 08 - cm 30 L x 14 P x 7 H

907

Sgabello con 3 gambe
 Stool with 3 legs
 Tabouret avec 3 jambes
 Hocker mit 3 Beinen
 Стул на 3-х ножках
 cm Ø 32 x 45 H

- 08
- 02 - 03 - 04
- 16 - 25 - 26 - 36

G 627 VULCI

Sgabello con 3 gambe
 Stool with 3 legs
 Tabouret avec 3 jambes
 Hocker mit 3 Beinen
 Стул на 3-х ножках
 cm Ø 32 x 45 H

- 08
- 02 - 03 - 04
- 16 - 25 - 26 - 36

878

Sgabello con 4 gambe inox 304
 Stool with 4 legs inox 304
 Tabouret avec 4 jambes inox 304
 Hocker mit 4 Beinen aus Edelstahl 304
 Стул на 4-х ножках
 cm 32 L x 32 P x 45 H

- 54

650

Sgabello con 4 gambe
 Stool with 4 legs
 Tabouret avec 4 jambes
 Hocker mit 4 Beinen
 Стул на 4-х ножках
 cm Ø 36 x 40 H

- 08

Kg 110 Carico statico
 Static load / Charge statique / Statische Belastung /
 статическая нагрузка
 CE norma MDD 93/42



907



G 627



878



650



979



1137/TR



1137/23



1137/01

979

Sgabello plexiglass
 Plexiglass stool
 Tabouret en plexiglass
 Hocker mit Plexiglas
 оргстекло стул
 cm 28 L x 25 P x 44 H

- 08
- 16 - 25

1137

Sgabello plexiglass
 Plexiglass stool
 Tabouret en plexiglass
 Hocker mit Plexiglas
 оргстекло стул
 cm 28 L x 25 P x 44 H

- TR
- 01 - 23

994

Cestino con coperchio
ELITE / MARTE / IDRA
Dustbin with cover
Panier avec couverture
Korb mit Deckel
Контейнер для мусара
cm Ø 19 x 25 H

- 08
- 16 - 25



08



25



16

994

Cestino con coperchio
PRISMA / NEMI / NOTO / NOTO LIGHT
Dustbin with cover
Panier avec couverture
Korb mit Deckel
Контейнер для мусара
cm Ø 21 x 25 H

- 08
- 16 - 25



994 EL



994 MA

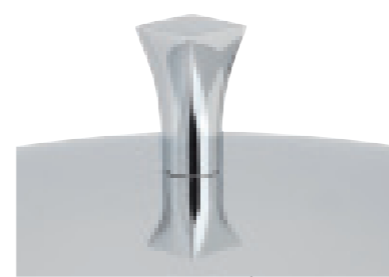

994 PR



994 NE



994 NTV



994 NT

997

Sgabello contenitore inox 304 con ecopelle
Stainless steel and ecoleather container for lingerie
Container pour linge inox et faux cuir
Edelstahl-Wäschekorb
корзина для белья на стене
cm 32 L x 32 P x 52 H

- 55
- 16 - 25
- 24 - 28



997 - 55



997 - 24



997 - 23

Varietà, funzionalità e stile



HOTELLERIE

Designer: Stilhaus
Fuori misura: No

Designer: Stilhaus
Customized: No

Designer: Stilhaus
Personnalis : No

Designer: Stilhaus
Kundenw nsche: Nein

Разработка дизайна: Stilhaus
Негабаритный: не



VE 04

Mensola con piano in vetro trasparente 8 mm
Shelf with transparent glass plane 8 mm
Étagère avec plan en verre transparent 8 mm
Ablage aus klarem Glas 8 mm
Стеклопанельная полка - толщина стекла 8 мм
cm 60 L x 12 P x 5 H

• 08



LZ 05

Asta porta asciugamani
Towel rail
Porte serviette
Handtuchhalter
Полотенцедержатель
cm 61 L x 7 P x 5 H

• 08



LZ 05.2

Porta asciugamani doppia asta
Towel rail 2 bars
Porte serviette avec 2 bar
Doppel-Handtuchstange
олотенцедержатель двойной
cm 61 L x 11 P x 5 H

• 08



LZ 10 M

Porta bicchiere in ottone
Brass glass holder
Porte verre en laiton
Zahnbürstenhalter aus Messing
Настенный металлический стакан
cm 7 L x 11 P x 11 H

• 08



LZ 30 V

Porta dosatore sapone liquido
Wall-mounted liquid soap dispenser
Doseur de savon liquide
Seifenspender
Настенный стеклянный дозатор для мыла
cm 5 L x 9 P x 18 H

• 08



LZ 11

Porta rotolo
Paper holder
Porte rouleau
Papierrollenhalter
Настенный бумагодержатель
cm 17 L x 7 P x 4,5 H

• 08



LZ 45

Asta porta asciugamani
Towel rail
Porte serviette
Handtuchhalter
Полотенцедержатель
cm 61 L x 7 P x 5 H

• 08



LZ 06

Asta porta salviette
Serviette holder
Porte serviettes
Handtuchhalter
Полотенцедержатель
cm 33 L x 7 P x 5 H

• 08



LZ 07

Anello porta salviette
Serviette holder to ring shaped
Porte serviettes à anneau
Handtuchring
Полотенцедержатель - кольцо
cm 23 Ø x 5 P x 26 H

• 08



LZ 11 S

Porta rotolo di scorta
Paper holder of supply
Porte rouleau d'escorte
Ersatzpapierrollenhalter
Вертикальный бумагодержатель
cm 5 L x 7 P x 17 H

• 08



LZ 11 C

Porta rotolo con coperchio
Covered paper holder
Porte rouleau avec couvercle
Papierrollenhalter mit Deckel
Настенный бумагодержатель закрытый
cm 14 L x 12 P x 13 H

• 08



LZ 11.2

Porta rotolo doppio
Paper holder of supply
Porte rouleau d'escorte
Doppel - Papierrollenhalter
Настенный бумагодержатель двойной
cm 25,5 L x 7 P x 5 H

• 08



LZ 09 V

Porta sapone in vetro
Glass soap dish
Porte savon en verre
Seifenschale aus Glas
Настенная стеклянная мыльница
cm 12 L x 12 P x 8 H

• 08



LZ 09 M

Porta sapone in ottone
Brass soap dish
Porte savon en laiton
Seifenschale aus Messing
Настенная металлическая мыльница
cm 12 L x 8 P x 9 H

• 08



LZ 10 V

Porta bicchiere in vetro
Glass holder
Porte verre en verre
Zahnbürstenhalter aus Glas
Настенный стеклянный стакан
cm 7 L x 10 P x 9 H

• 08

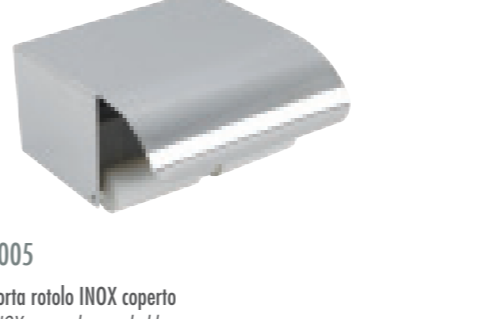

1005

Porta rotolo INOX coperto
INOX covered paper holder
Porte rouleau avec couvercle en INOX
Papierrollenhalter INOX mit Deckel
Настенный бумагодержатель закрытый
cm 12 L x 13 P x 6 H

• 08



LZ 809

Porta accappatoio (2 gancio)
Robe hook (2 hooks)
Porte peignoir (2 crochets)
Bademantelhaken (2 Haken)
Ключок
cm 5,5 L x 5,5 P x 5,5 H

• 08

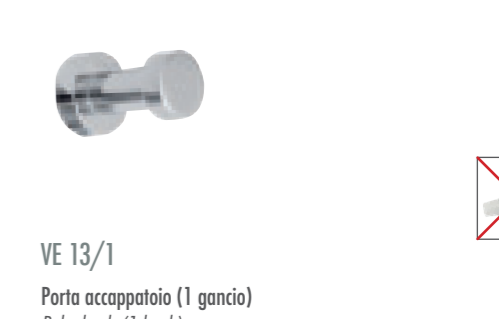

VE 13/1

Porta accappatoio (1 gancio)
Robe hook (1 hook)
Porte peignoir (1 crochet)
Bademantelhaken (1 Haken)
Ключок
cm 1 L x 4 P x 1 H

• 08





VE 13/3

Porta accappatoio (3 ganci)
 Robe hook (3 hooks)
 Porte peignoir (3 crochets)
 Bademantelhaken (3 Haken)
 Ключок тройной
 cm 15 L x 4,5 P x 2 H

• 08



LZ 039

Porta scopino in ottone
 Brass toilet-brush
 Porte balayent en laiton
 Bürstengarnitur aus Messing
 Напольный
 cm 8 Ø x 42 H

• 08



LZ 039 M

Porta scopino a parete
 Wall mounted toilet-brush
 Porte balayent à mur
 Bürstengarnitur wandhängend
 Настенный металлический ёрш
 cm 8 Ø x 42 H

• 08



495

Distributore sapone liquido (Lt.1,2) in acciaio inox
 Stainless steel distributor liquid soap (Lt.1,2)
 Distributif de savon liquide (Lt.1,2) en acier inox
 Seifenspender (Lt.1,2) aus Edelstahl
 Дозатор для мыла - 1,2 литра
 cm 9 L x 11 P x 30 H

• 55



494

Distributore sapone liquido in ABS
 ABS distributor liquid soap
 Distributif de savon liquide en ABS
 Seifenspender aus ABS
 Дозатор для мыла - литра
 cm 10 L x 8 P x 25 H

• 55



921

Distributore sapone liquido (Lt.0,8) in acciaio inox
 Stainless steel distributor liquid soap (Lt.0,8)
 Distributif de savon liquide (Lt.0,8) en acier inox
 Seifenspender (Lt.0,8) aus Edelstahl
 Дозатор для мыла - 0,8 литра
 cm 9 L x 8 P x 19 H

• 55

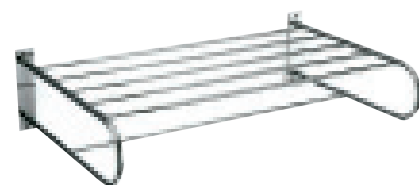

748

Griglia portasciugamani con 6 aste
 Towel holder grill with 6 bars
 Grille porte serviettes avec 6 barres
 Badetuchablage mit Handtuchhalter 6 Stangen
 Решётка для полотенец - 6 прутьев
 cm 48 L x 28 P x 10 H

• 08



786

Griglia portasciugamani con 6 aste
 Towel holder grill with 6 bars
 Grille porte serviettes avec 6 barres
 Badetuchablage mit Handtuchhalter 6 Stangen
 Решётка для полотенец - 6 прутьев
 cm 54 L x 28 P x 11 H

• 08

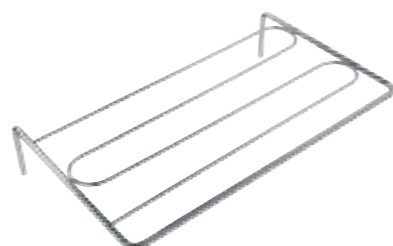

1069

Griglia portasciugamani con 5 aste
 Towel holder grill with 5 bars
 Grille porte serviettes avec 5 barres
 Badetuchablage mit Handtuchhalter 5 Stangen
 Решётка для полотенец - 5 прутьев
 cm 55 L x 30 P x 10 H

• 08



K 32

Distributore sapone liquido (Lt.0,17) in ABS
 ABS distributor liquid soap (Lt.0,17)
 Distributif de savon liquide (Lt.0,17) en ABS
 Seifenspender (Lt.0,17) aus ABS
 Дозатор для мыла - 0,17 литра
 cm 5,5 L x 7 P x 14 H

• 08



K 22

Distributore sapone liquido (Lt.1,2)
 Distributor liquid soap (Lt.1,2)
 Distributif de savon liquide (Lt.1,2)
 Seifenspender (Lt.1,2)
 Дозатор для мыла
 cm 13 L x 10 P x 23 H

• 01



K 19

Distributore asciugamani, fogli carta C o rotoli
 Distributor towels in sheets paper C and rolls
 Distributif serviettes, papier C or tu roulees
 Papierhandtuchspender für C-Falz Handtücher oder Rollen
 Ящик для гигиенической рулонной бумаги
 cm 22 L x 12 P

• 01



493

Distributore asciugamani di carta in acciaio inox
 Stainless steel distributor paper towels
 Distributif serviettes de papier en acier inox
 Papierhandtuchspender aus Edelstahl
 Ящик для бумажных полотенец
 cm 26 L x 12 P x 43 H

• 55



925

Distributore carta igienica a fogli in acciaio inox
 Stainless steel distributor hygienic paper in sheets
 Distributif papier hygiénique feuilles en acier inox
 Toilettenpapierspender für Einzelblatt Entnahme aus Edelstahl
 Ящик для бумажных полотенец в листах
 cm 13 L x 13 P x 31 H

• 55



496

Distributore carta igienica in acciaio inox
 Stainless steel distributor hygienic paper
 Distributif papier hygiénique en acier inox
 Toilettenpapierspender aus Edelstahl
 Ящик для бумажных полотенец
 cm 31 Ø x 13 P

• 55



K 23

Distributore carta igienica
 Distributor hygienic paper
 Distributif papier hygiénique
 Toilettenpapierspender
 Ящик для гигиенической бумаги
 cm Ø 19 x 12 P

• 01



K 27

Distributore sacchetti igienici
 Sanitary bags dispenser
 Distributif sachets hygiénique
 Hygienebeutel Spender
 Дозатор для гигиенических пакетов
 cm 13 L x 5 P x 29 H

• 08

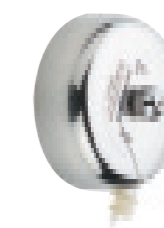

K 26

Filo stendi biancheria
 Retractable clothes line
 Fil étendoir
 Wäscheleine
 Выдвижная бельевая верёвка
 cm 9 Ø x 5/200 L

• 55



K 24

Distributore fazzoletti carta ABS
 Distributor handkerchiefs paper ABS
 Distributif mouchoirs papier ABS
 Spender für Kosmetiktücher ABS
 Ящик для листовой бумаги ABS
 cm 26 L x 12 P x 5 H

• 08



981

Distributore fazzoletti carta inox
 Distributor handkerchiefs paper inox
 Distributif mouchoirs papier inox
 Spender für Kosmetiktücher inox
 Ящик для листовой бумаги inox
 cm 26 L x 12 P x 5 H

• 55

• 16



1122

Distributore fazzoletti carta inox
 Distributor handkerchiefs paper inox
 Distributif mouchoirs papier inox
 Spender für Kosmetiktücher inox
 Ящик для листовой бумаги inox
 cm 14 L x 12,5 P x 13 H

• 55

• 16



K 40

Asciugacapelli elettrico a parete
 Wall-mounted electrical hairdryer
 Séché-cheveux électrique à mur
 Elektrischer Wandhaartrockner
 Электрический фен
 cm 25 L x 14 P x 27 H
 CE: V 230 W 1500 IP 24



055 PIKKOLO

Asciugacapelli elettrico a parete con avviamento a pulsante
 Wall-mounted electrical hairdryer with push button starter
 Séché-cheveux électrique à mur démarrage avec bouton
 Elektrischer Wandhaartrockner mit Start-Taste
 Электрический фен
 cm 11 L x 21 H
 CE: V 220 W 1500 IP 24



478.3LT

Contenitore per rifiuti inox con pedale
 Stainless steel refusals container with pedal
 Containeur pour refus en acier inox avec pédale
 Abfalleimer aus Edelstahl mit Fußpedal
 Контейнер для мусора с педалью
 cm ø 17 x 25 H

• 55

• 25 - 16

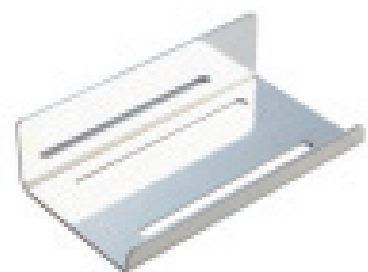

1043

Mensola di cortesia inox
 Courtesy bracket inox
 Étagère
 Ablage
 Полка для туалетных принадлежностей
 cm 10 L x 5 P x 3 H

• 55

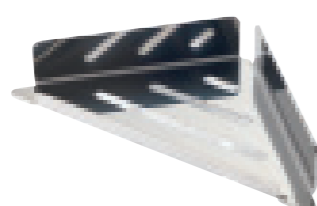

1138

Mensola di cortesia ad angolo inox
 Courtesy bracket inox
 Étagère
 Ablage
 Полка для туалетных принадлежностей
 cm 13 L x 13 P x 2,5 H

• 55



1059

Vaschetta di cortesia inox
 Storage tray inox
 Tablet
 Tablet
 Лоток для туалетных принадлежностей
 cm 20 L x 12 P x 3 H

• 55



478.5LT

Contenitore per rifiuti inox con pedale
 Stainless steel refusals container with pedal
 Containeur pour refus en acier inox avec pédale
 Abfalleimer aus Edelstahl mit Fußpedal
 Контейнер для мусора с педалью
 cm ø 21 x 29 H

• 55

• 25 - 16

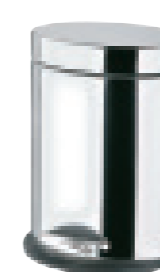

802.3L OVALE

Contenitore (3lt.) per rifiuti inox con pedale
 Stainless steel refusals container (3 Lt.) with pedal
 Containeur (3Lt.) pour refus inox avec pédale
 Abfalleimer (3Lt.) aus Edelstahl mit Fußpedal
 Овальный контейнер для мусора
 cm 19 L x 14,3 P x 26,5 H

• 55



803.3L QUADRO

Contenitore (3lt.) per rifiuti inox con pedale
 Stainless steel refusals container (3 Lt.) with pedal
 Containeur (3Lt.) pour refus inox avec pédale
 Abfalleimer (3Lt.) aus Edelstahl mit Fußpedal
 Квадратный контейнер для мусора
 cm 16 L x 16 P x 24,5 H

• 55



K 21

Asciugamani elettrico con fotocellula
 Towels electrical worker with photoelectric cell
 Serviettes électrique avec photocellule
 Automatischer Handtrockner
 Сушилка для рук
 cm 18 L x 12 P x 28 H
 CE: V 220 W 1500 IP 24

• 08

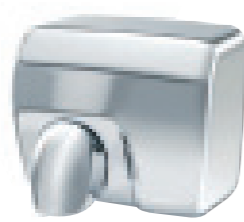

K 39

Asciugamani elettrico con fotocellula
 Towels electrical worker with photoelectric cell
 Serviettes électrique avec photocellule
 Automatischer Handtrockner
 Сушилка для рук
 cm 27 L x 20 P x 24 H
 CE: V 220 W 2500 IP 24

• 55



056

Asciugacapelli a parete
 Wall hair dryer
 Séché-cheveux à mur
 Wandhaartrockner
 Электрический фен
 cm 14 L x 45 H
 CE: V 220 W 800 IP 24

• 056.00 Con avviamento automatico
 Whit automatic start/Avec démarrage automatique
 Mit automatischem Start/c автоматическим стартом

• 056.01 Con timer 10 minuti
 With timer 10 minuter / Avec timer 10 minutes
 Mit 10 Minuten Timer / с таймером на 10 минут



478.12

Contenitore per rifiuti inox con pedale (12 lt)
 Stainless steel refusals container with pedal (12 lt)
 Containeur pour refus en acier inox avec pédale (12 lt)
 Abfalleimer aus Edelstahl mit Fußpedal (12 lt)
 Контейнер для мусора с педалью (12 lt)
 cm ø 25 x 40 H

• 55



987

Contenitore per rifiuti inox (12 lt)
 Stainless steel refusals container (12 lt)
 Containeur pour refus en acier inox (12 lt)
 Abfalleimer aus Edelstahl (12 lt)
 Контейнер для мусора (12 lt)
 cm ø 23 x 28 H

• 55



K 41

Contenitore per rifiuti ABS (25 lt)
 ABS refusals container (25 lt)
 Containeur pour refus en ABS (25 lt)
 Abfalleimer aus ABS (25 lt)
 Контейнер для ABS (25 lt)
 cm 35 L x 27 P x 48 H

• 01



K 01

Specchio basculante con vetro antinfortunistica
Adjustable mirror with accident-prevention glass
Mirror basculant avec verre anti prévention des accidents
Bewegbarer Spiegel aus Sicherheitsglas
Навесное зеркало с защитным стеклом
cm 61 L x 70 H

• 01



K 01.02

Specchio con vetro antinfortunistica
Mirror with accident-prevention glass
Mirror avec verre anti prévention des accidents
Spiegel aus Sicherheitsglas
Зеркало с защитным стеклом
cm 60 L x 90 H

• 01

CORRIMANO IN ACCIAIO VERNICIATO CONFORMI ALLA NORMATIVA D.P.R. 503/96



K 02

Corrimano di sicurezza orizzontale
in acciaio verniciato
Horizontal emergency handle en stell-clad
Poignée de sûreté horizontale en acier inox
Bad Sicherheitsgriff aus beschichtetem Stahl
Горизонтальный поручень

- K 02.01 - cm 30
- K 02.02 - cm 40
- K 02.03 - cm 60
- K 02.04 - cm 90

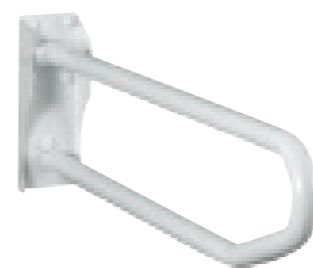

K 07

Impugnatura di sostegno ribaltabile
Rotary support handle en stell-clad
Poigne de soutien tournant en acier inox
Stützklappgriff
Складная ручка
cm 10 L x 60 P x 21 H

• 01

Con dispositivo di bloccaggio in posizione verticale.
With blocking device in vertical position
Avec dispositif de blocage en position verticale
Mit Sperre in die senkrechte Position
Крепеж на клей

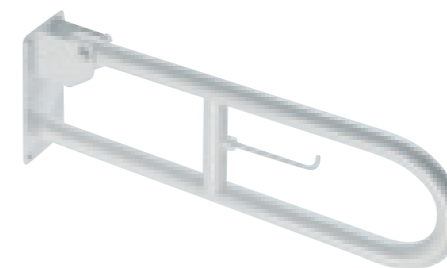

K 17

Impugnatura di sostegno ribaltabile con porta rotolo
Rotary support handle with paper holder en stell-clad
Poigne de soutien tournant avec porte rouleau en acier inox
Bad Sicherheitsgriff klappbar mit Papierrollenhalter
Складная ручка + держатель для рулона
cm 10 L x 60 P x 21 H

• 01

Con dispositivo di bloccaggio in posizione verticale.
With blocking device in vertical position
Avec dispositif de blocage en position verticale
Mit Sperre in die senkrechte Position
Крепеж на клей



K 06

Impugnatura di sostegno fissa
Fixed support handle
Poigne de soutien fixe
Bad Haltestange
Поручень правосторонний
cm 16 L x 80 P x 20 H

• 01

Con rinforzo sinistro
With left reinforce / Avec je renforce gauche
Mit Verstärkung links / с фиксацией слева

• 01

Con rinforzo destro (come foto)
With right reinforce (same photo) / Avec je renforce droite (come photo)
Mit Verstärkung rechts (wie auf dem Bild) / с фиксацией право



K 03

Corrimano di sicurezza orizzontale con 3
attacchi a parete
Horizontal emergency handle with 3 wall attacks
Poignée de sûreté horizontale avec 3 attaques à mur
Bad Sicherheitsgriff mit 3 Wandhalterungen
Перила на 3-х креплениях

- K 03.01 - cm 130
- K 03.02 - cm 150
- K 03.03 - cm 200



K 04

Corrimano di sicurezza ad angolo
Corner horizontal emergency handle
Poignée de sûreté horizontale à angle
Eck-Wandhandlauf waagrecht
Угловый поручень
cm 40 L x 70 H

- K 04.02 - cm 70 x 70
- K 04.03 - cm 100 x 100



K 08

Impugnatura di sostegno a parete
Wall support handle
Poigne de soutien à mur
Winkelgriff
Поручень правосторонний угловой
cm 40 L x 70 H

- K 08 SX
- K 08 DX come foto

same photo / comme photo / wie auf dem Bild/Как фото



K 11

Corrimano verticale pavimento-parete
Vertical emergency handle floor-wall
Poignée de sûreté vertical
Wandhandlauf Boden-Wandstützgriff
Вертикальный поручень
cm 180 H

- 01



K 05

Impugnatura di sostegno da parete a pavimento
Support handle from wall to floor
Poigne de soutien de mur à plancher
Bad Haltestange Boden-Wandstützgriff
Поручень от стены к полу
cm 180 H

• 01

NYLON-ALLUMINIO



K 13

Sedile ribaltabile in nylon-alluminio con fissaggio a parete
Rotary seat in nylon-aluminium with wall fixing
Siège tournant en nylon-aluminium avec fixation à mur
Duschklappsitz aus Nylon-Aluminium für Wandmontage
Настенное сидение складное из нейлона/алюминия
cm 50 L x 35 P x 54 H

• 01

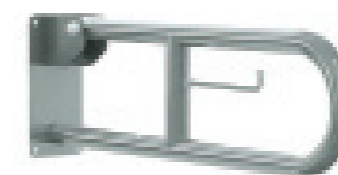

K 17 INOX

Impugnatura di sostegno ribaltabile con porta rotolo
Rotary support handle with paper holder en stell-clad
Poigne de soutien tournant avec porte rouleau en acier inox
Bad Sicherheitsgriff klappbar mit Papierrollenhalter
Складная ручка + держатель для рулона
cm 10 L x 60 P x 21 H

• 55

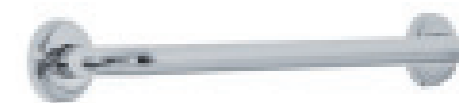

K 02 INOX

Corrimano di sicurezza orizzontale in acciaio lucido
Horizontal emergency handle en stell
Poignée de sûreté horizontale en acier inox
Bad Sicherheitsgriff aus beschichtetem Stahl
Горизонтальные поручни из полированной стали

- K 02.01.08 - cm 36
- K 02.02.08 - cm 40
- K 02.03.08 - cm 60
- K 02.04.08 - cm 90

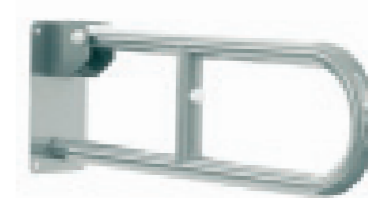

K 07 INOX

Impugnatura di sostegno ribaltabile
Rotary support handle en stell-clad
Poigne de soutien tournant en acier inox
Stützklappgriff
Складная ручка
cm 10 L x 60 P x 21 H

• 55

Con dispositivo di bloccaggio in posizione verticale.
With blocking device in vertical position
Avec dispositif de blocage en position verticale
Mit Sperre in die senkrechte Position
Крепеж на клей

SPARE PARTS / PIÈCES DE RECHANGE / ERSATZTEILE / ЗАПАСНЫЕ ЧАСТИ

**040 Bicchieri di ricambio**

Glass spare / Verre de rechange / Ersatz Zahnputzbecher / Запасные стаканы

BIANCO	DECORATO - COLORATO
White	Decorated - Coloured
Bianc	Décoré - Coloré
Weiß	Bemalt - Farbig

- **01** Bicchiere in ceramica per MINERVA, OMEGA Ø cm 5,6
Ceramic glass for Minerva, Omega - Verre en céramique pour Minerva, Omega - Zahnputzbecher aus Keramik für Minerva, Omega
- **02** Bicchiere in ceramica per GIUNONE Ø cm 8,2
Ceramic glass for Giunone - Verre en céramique pour Giunone - Zahnputzbecher aus Keramik für Giunone
- **03** Bicchiere in ceramica per NEMI, IDRA Ø cm 7,4
Ceramic glass for Nemi, Idra - Verre en céramique pour Nemi, Idra - Zahnputzbecher aus Keramik für Nemi, Idra
- **04** Bicchiere in ceramica per SMART, FLORA Ø cm 6,0
Ceramic glass for Smart, Flora - Verre en céramique pour Smart, Flora - Zahnputzbecher aus Keramik für Smart, Flora
- **05** Bicchiere in vetro per ALFA Ø cm 5,7
Glass for Alfa - Verre pour Alfa - Zahnputzbecher aus Glas für Alfa
- **06** Bicchiere in vetro per LIZ VETRO Ø cm 5,9
Glass for Liz glass - Verre pour Liz verre - Zahnputzbecher aus Glas für Liz
- **07** Bicchiere in ceramica per ZOE Ø cm 6,0
Ceramic glass for Zoe - Verre en céramique pour Zoe - Zahnputzbecher aus Keramik für Zoe
- **08** Bicchiere in vetro per MEDEA, DIANA Ø cm 6,2
Glass for Medea, Diana - Verre pour Medea, Diana - Zahnputzbecher aus Glas für Medea, Diana
- **09** Bicchiere in ceramica con perno per URANIA
Ceramic glass with bolt for Urania - Verre en céramique avec boulon pour Urania - Zahnputzbecher aus Keramik mit Zapfen für Urania
- **11** Bicchiere in vetro per SMART LIGHT, NOTO, MARTE Ø cm 5,9
Glass for Smart Light, Noto, Marte - Verre pour Smart Light, Noto, Marte - Zahnputzbecher aus Glas für Smart Light, Noto, Marte
- **12** Bicchiere in ceramica con perno per BUCKET, OPERA
Ceramic glass with bolt for Bucket, Opera - Verre en céramique avec boulon pour Bucket, Opera - Zahnputzbecher aus Keramik mit Zapfen für Bucket, Opera
- **13** Bicchiere in ceramica per MIZAR
Ceramic glass for Mizar - Verre en céramique pour Mizar - Zahnputzbecher aus Keramik für Mizar
- **14** Bicchiere in vetro con perno per QUID
Glass with bolt for Quid - Verre en verre avec boulon pour Quid - Zahnputzbecher aus Glas mit Zapfen für Quid
- **15** Bicchiere in vetro con perno per VENUS (foto)
Glass with bolt for Venus - Verre en verre avec boulon pour Venus - Zahnputzbecher aus Glas mit Zapfen für Venus
- **16** Bicchiere in ceramica con perno per ZEFIRO
Ceramic glass with bolt for Zefiro - Verre en céramique avec boulon pour Zefiro - Zahnputzbecher aus Keramik mit Zapfen für Zefiro
- **17** Bicchiere in ceramica con perno per PRISMA
Ceramic glass with bolt for Prisma - Verre en céramique avec boulon pour Prisma - Zahnputzbecher aus Keramik mit Zapfen für Prisma
- **18** Bicchiere in vetro per ELITE Ø cm 10
Glass for Elite - Verre pour Elite - Zahnputzbecher aus Glas für Elite
- **19** Bicchiere in ceramica con perno per LIVING, GEA
Ceramic glass with bolt for Living, Gea - Verre en céramique avec boulon pour Living, Gea - Zahnputzbecher aus Keramik mit Zapfen für Living, Gea
- **20** Bicchiere in ceramica con perno per DIVA, FLUID
Ceramic glass with bolt for Diva, Fluid - Verre en céramique avec boulon pour Diva, Fluid - Zahnputzbecher aus Keramik mit Zapfen für L Diva, Fluid
- **21** Bicchiere in ceramica con perno per LIZ
Ceramic glass with bolt for Liz - Verre en céramique avec boulon pour Liz - Zahnputzbecher aus Keramik mit Zapfen für Liz

**041 Porta sapone di ricambio**

Soap dish spare / Porte savon de rechange / Ersatz Seifenschale / Запасные мыльницы

BIANCO	DECORATO - COLORATO
White	Decorated - Coloured
Bianc	Décoré - Coloré
Weiß	Bemalt - Farbig

- **01** Porta sapone in ceramica per MINERVA Ø cm 4,5
Ceramic soap dish for Minerva - Porte savon en céramique pour Minerva - Seifenschale aus Keramik für Minerva
- **02** Porta sapone rettangolare in ceramica per PATRIZIA Ø cm 4,5
Ceramic soap dish for Patrizia - Porte savon en céramique pour Patrizia - Seifenschale rechteckig aus Keramik für Patrizia
- **03** Porta sapone in ceramica per GIUNONE Ø cm 6,5
Ceramic soap dish for Giunone - Porte savon en céramique pour Giunone - Seifenschale aus Keramik für Giunone
- **04** Porta sapone in ceramica per NEMI, IDRA Ø cm 7,5
Ceramic soap dish for Nemi, Idra - Porte savon en céramique pour Nemi, Idra - Seifenschale aus Keramik für Nemi, Idra
- **05** Porta sapone in ceramica per SMART, FLORA Ø cm 6
Ceramic soap dish for Smart, Flora - Porte savon en céramique pour Smart, Flora - Seifenschale aus Keramik für Smart, Flora
- **06** Porta sapone in ceramica per OMEGA Ø cm 6,2
Ceramic soap dish for Omega - Porte savon en céramique pour Omega - Seifenschale aus Keramik für Omega
- **07** Porta sapone in vetro per ALFA, ELITE Ø cm 6,2
Glass soap dish for Alfa, Elite - Porte savon en verre pour Alfa, Elite - Seifenschale aus Glas für Alfa, Elite
- **08** Porta sapone in vetro per LIZ VETRO Ø cm 5,9
Glass soap dish for Liz glass - Porte savon en verre pour liz verre - Seifenschale aus Glas für Liz
- **10** Porta sapone in ceramica con perno per URANIA
Ceramic soap dish with bolt for Urania - Porte savon en céramique avec boulon pour Urania - Seifenschale aus Keramik mit Zapfen für Urania
- **12** Porta sapone in vetro per SMART LIGHT, NOTO, MARTE Ø cm 6,2
Glass soap dish for Smart Light, Noto, Marte - Porte savon en verre pour Smart Light, Noto, Marte - Seifenschale aus Glas für Smart Light, Noto, Marte
- **13** Porta sapone in vetro per DIANA Ø cm 6,5
Glass soap dish for Diana - Porte savon en verre pour Diana - Seifenschale aus Glas für Diana
- **14** Porta sapone in ceramica per MIZAR
Ceramic soap dish for Mizar - Porte savon en céramique pour Mizar - Seifenschale aus Keramik für Mizar
- **15** Porta sapone in vetro con perno per VENUS (foto)
Glass soap dish with bolt for Venus - Porte savon en verre avec boulon pour Venus - Seifenschale aus Glas mit Zapfen für Venus
- **16** Porta sapone in ceramica con perno per ZEFIRO
Ceramic soap dish with bolt for Zefiro - Porte savon en céramique avec boulon pour Zefiro - Seifenschale aus Keramik mit Zapfen für Zefiro
- **17** Porta sapone in ceramica con perno per PRISMA
Ceramic soap dish with bolt for Prisma - Porte savon en céramique avec boulon pour Prisma - Seifenschale aus Keramik mit Zapfen für Prisma
- **18** Porta sapone in vetro con perno per QUID
Glass soap dish with bolt for Quid - Porte savon en verre avec boulon pour Quid - Seifenschale aus Glas mit Zapfen für Quid
- **19** Porta sapone in ceramica con perno per GEA
Ceramic soap dish with bolt for Gea - Porte savon en céramique avec boulon pour Gea - Seifenschale aus Keramik mit Zapfen für Gea
- **20** Porta sapone in ceramica con perno per DIVA, FLUID
Ceramic soap dish with bolt for Diva, Fluid - Porte savon en céramique avec boulon pour Diva, Fluid - Seifenschale aus Keramik mit Zapfen für Diva, Fluid
- **21** Porta sapone in ceramica con perno per BUCKET, OPERA
Ceramic soap dish with bolt for Bucket, Opera - Porte savon en céramique avec boulon pour Bucket, Opera - Seifenschale aus Keramik mit Zapfen für Bucket, Opera
- **22** Porta sapone in ceramica con perno per LIZ
Ceramic soap dish with bolt for Liz - Porte savon en céramique avec boulon pour Liz - Seifenschale aus Keramik mit Zapfen für Liz

**037 Dosatore sapone liquido di ricambio**

Liquid soap dispenser spare / Doseur de savon liquid de rechange
Ersatz Seifenspender / Запасные дозаторы

BIANCO
White
Blanc
Weiß

COLORATO
Coloured
Coloré
Farbig

- **01** Dosatore in vetro per ELITE, LIZ VETRO Ø cm 6,0
Glass dispenser for Elite, Liz glass - Doseur en verre pour Elite, Liz - Seifenspender aus Glas für Elite, Liz
- **02** Dosatore in ceramica per GIUNONE Ø cm 7,0
Ceramic dispenser for Giunone - Doseur en céramique pour Giunone - Seifenspender aus Keramik für Giunone
- **03** Dosatore in vetro per DIANA Ø cm 6,2
Glass dispenser for Diana - Doseur en verre pour Diana - Seifenspender aus Glas für Diana
- **04** Dosatore in ceramica per SMART Ø cm 6,0
Ceramic dispenser for Smart - Doseur en céramique pour Smart - Seifenspender aus Keramik für Smart
- **06** Dosatore in ceramica con perno per URANIA
Ceramic dispenser with bolt for Urania - Doseur en céramique avec boulon pour Urania - Seifenspender aus Keramik mit Zapfen für Urania
- **07** Dosatore in vetro con perno per VENUS Ø cm 6,0
Glass dispenser with bolt for Venus - Doseur en verre avec boulon pour Venus - Seifenspender aus Glas mit Zapfen für Venus
- **10** Dosatore in ceramica con perno per BUCKET, OPERA Ø cm 7,0
Ceramic dispenser with bolt for Bucket, Opera - Doseur en céramique avec boulon pour Bucket, Opera - Seifenspender aus Keramik mit Zapfen für Bucket, Opera
- **11** Dosatore in ceramica per MIZAR Ø cm 6,2
Ceramic dispenser for Mizar - Doseur en céramique pour Mizar - Seifenspender aus Keramik für Mizar
- **12** Dosatore in ceramica con perno per ZEFIRO Ø cm 6,0
Ceramic dispenser with bolt for Zefiro - Doseur en céramique avec boulon pour Zefiro - Seifenspender aus Keramik mit Zapfen für Zefiro
- **13** Dosatore in ceramica con perno per PRISMA
Ceramic dispenser with bolt for Prisma - Doseur en céramique avec boulon pour Prisma - Seifenspender aus Keramik mit Zapfen für Prisma
- **14** Dosatore in vetro con perno per QUID
Glass dispenser with bolt for Quid - Doseur en verre avec boulon pour Quid - Seifenspender aus Glas mit Zapfen für Quid
- **15** Dosatore in ceramica con perno per LIVING
Ceramic dispenser with bolt for Living - Doseur en céramique avec boulon pour Living - Seifenspender aus Keramik mit Zapfen für Living
- **16** Dosatore in vetro per SMART LIGHT, NOTO, MARTE Ø cm 6,2
Glass dispenser for Smart Light, Noto, Marte - Doseur en verre pour Smart Light, Noto, Marte - Seifenspender aus Glas für Smart Light, Noto, Marte
- **17** Dosatore in ceramica per DIVA, FLUID
Ceramic dispenser for Diva, Fluid - Doseur en céramique pour Diva, Fluid - Seifenspender aus Keramik für Diva, Fluid
- **OTTONE TONDO** Pompetta per dosatore (cromo) - Dispenser pump's (chrome) - Pompe pour doseur (chromé) - Pumpe für Seifenspender (Chrom)
- **OTTONE TONDO** Pompetta per dosatore (oro) - Dispenser pump's (gold) - Pompe pour doseur (or) - Pumpe für Seifenspender (Gold)

**091 Finale di ricambio**

End-knob / Final de rechange / Ersatz Endteil / Запасная насадка

LEGNO - OTTONE
Wood-brass
Bois-laiton
Halz-Messing

VETRO-CERAMICA BIANCA
White glass-ceramic
Verre-céramique Blanc
Weiß Glas-Keramik

DECORATO
Decorated
Décoré
Bemalt

- **01** Finale per NEMI - End-knob for Nemi - Endteil für Nemi
- **02** Finale per ALFA - End-knob for Alfa - Endteil für Alfa
- **06** Finale per SMART LIGHT (foto) - End-knob for Smart Light - Endteil für Smart Light

**042 Tazza per scopino di ricambio**

Container for toilet-brush / Containeur pour balayent
Ersatz Behälter für Bürstengarnitur / Запасная колба от ерша

BIANCO
White
Blanc
Weiß

DECORATO
Decorated
Décoré
Bemalt

- **01** Tazza in ceramica per MINERVA M 12 ø 5cm
Ceramic container for Minerva M 12 - Containeur en céramique pour Minerva M 12 - Behälter aus Keramik für Minerva M 12 -
- **02** Tazza in ceramica per: G 12/i 20/i 21 Ø cm 8,3x H22
Ceramic container for: G 12/i 20/i 21 - Containeur en céramique pour: G 12/i 20/i 21, Behälter aus Keramik für: G 12/i 20/i 21
- **03** Tazza in ceramica per: G 12a/i 12a (foto)
Ceramic container for: G 12a/i 12a - Containeur en céramique pour: G 12a/i 12a - Behälter aus Keramik für: G 12a/i 12a
- **04** Tazza in ceramica per GABRY 186
Ceramic container for Gabry 186 - Containeur en céramique pour Gabry 186 - Behälter aus Keramik für Gabry 186
- **05** Tazza in vetro per ELITE Ø cm 8,0x H23
Glass container for Elite - Containeur en verre pour Elite - Behälter aus Glas für Elite
- **06** Tazza in vetro per QUID, VENUS Ø cm 7,5x H23,5
Glass container for Quid, Venus - Containeur en verre pour Quid, Venus - Behälter aus Glas für Quid, Venus
- **09** Tazza in ceramica per BUCKET
Ceramic container for Bucket - Containeur en céramique pour Bucket - Behälter aus Keramik für Bucket
- **11** Tazza in ceramica per URANIA
Ceramic container for Urania - Containeur en céramique pour Urania - Behälter aus Keramik für Urania
- **12** Tazza in ceramica per ZEFIRO
Ceramic container for Zefiro - Containeur en céramique pour Zefiro - Behälter aus Keramik für Zefiro
- **13** Tazza in ceramica per COSI'
Ceramic container for Cosi - Containeur en céramique pour Cosi - Behälter aus Keramik für Cosi
- **14** Tazza in ceramica per LIVING, GEA
Ceramic container for Living, Gea - Containeur en céramique pour Living, Gea - Behälter aus Keramik für Living, Gea
- **15** Tazza in ceramica per ARIA
Ceramic container for Aria - Containeur en céramique pour Aria - Behälter aus Keramik für Aria
- **16** Tazza in ceramica per 972, ME 972
Ceramic container for 972, ME972 - Containeur en céramique pour 972, ME972 - Behälter aus Keramik für 972, ME972
- **17** Tazza in ceramica per DIVA, FLUID
Ceramic container for Diva, Fluid - Containeur en céramique pour Diva, Fluid - Behälter aus Keramik für Diva, Fluid
- **039F2** Tazza in PVC Ø 7cm - PVC container ø 7cm - Containeur en PVC ø 7cm - Behälter aus PVC ø 7cm

**095 Base di ricambio**

Spare Base / Base de rechange / Ersatz Fußplatte / Запасная основа

CROMO
Chrome
Chrom
Chrom

ORO-BRONZO
Gold-Bronze
Or-Bronze
Gold-Bronze

- **095.01** Base in ottone senza peso per piantane ø 25cm
Brass base without weight for stands ø 25cm - Base en laiton sans poids pour montants ø 25cm - Fußplatte aus Messing ohne Beschwerung für Ständer ø 25 cm
- **095.02** Base in ottone con peso per piantane Di 19 / U 19
Brass base with weight for Di 19 / U 19 - Base en laiton pour montants pour Di 19 / U 19 - Fußplatte aus Messing mit Beschwerung für Ständer Di 19 / U 19
- **01** Base in ottone per piantane senza peso ø 20 cm (foto)
Brass base without weight ø 20cm - Base en laiton pour montants sans poids ø 20cm - Fußplatte aus Messing ohne Beschwerung für Ständer ø 20cm

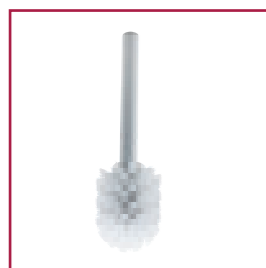
**050 Manico con ciuffo di ricambio**

Handle with brush / Poignée avec touffe / Griff und Ersatzbürstenkopf / Запасная щетка от ерша

CROMO-BIANCO
White-Chrome
Blanc-Chromé
Weiß-Chrom

ORO-BRONZO
Gold-Bronze
Or-Bronze
Gold-Bronze

- **050.01** Manico per Gabry - Handle for Gabry - Poignée pour Gabry - Griff für Gabry
- **050.02** Manico con ciuffo in PVC - Handle with PVC brush - Poignée avec touffe en PVC - Griff und Bürstenkopf aus Kunststoff (PVC)
- **050.03** Manico + ciuffo in setola + coperchio per scopino
Handle + bristle brush + cover toilet-brush - Poignée + touffe en brin + couvercle pour balayent - Griff + Bürstenkopf mit Borsten + Deckel
- **050.04** Coperchio in ottone per scopino ø cm 8
Brass cover for toilet-brush - Couvercle en laiton pour balayent - Deckel aus Messing für Bürstengarnitur
- **093** Ciuffo in PVC grande di ricambio - Spare PVC big brush - Touffe grand en PVC de rechange - Bürstenkopf groß aus PVC
- **051** Rullino per porta rotolo di ricambio - Spare part for paper holder - Rechange pour porte rolou - Ersatzteil für Rollenhalter
- **103** Gambo con ciuffo in setola cm 14 (foto) - Stem with bristle brush cm 14 - Tige avec touffe en brin cm 14 - Stielbürste und Bürstenkopf, Borsten cm 14
- **103.NE** Gambo con ciuffo in setola cm 14 - Stem with bristle brush cm 14 - Tige avec touffe en brin cm 14 - Stielbürste und Bürstenkopf, Borsten cm 14
Nero / Black / Noir / Swarz / Хром

**VET Paralumi di ricambio**

Spare lampshades / Abat-jour de rechange / Ersatz Lampen gläser / абажуром замена

BIANCO
White
Blanc
Weiß

DECORATO - COLORATO
Decorated - Coloured
Décoré - Coloré
Bemalt - Farbig

- **VET N 17** Vetro per N 17 - Glass for N 17 - Verre pour N 17 - Lampenglas für N 17
- **VET 692** Vetro per 692 - Glass for 692 - Verre pour 692 - Lampenglas für 692
- **VET CA 17** Vetro per CA 17 - Glass for CA 17 - Verre pour CA 17 - Lampenglas für CA 17
- **VET 657** Vetro per 657 - Glass for 657 - Verre pour 657 - Lampenglas für 657
- **VET 582** Vetro Pirex per: 582/609/602
Glass Pirex for: 582/609/602 - Verre Pirex pour: 582/609/602 - Pyrex Glas für: 582/609/602
- **VET 629** Vetro Pirex per 629 - Glass Pirex for 629 - Verre Pirex pour 629 - Pyrex Glas für 629
- **VET 656** Vetro Pirex per 656 - Glass Pirex for 656 - Verre Pirex pour 656 - Pyrex Glas für 656
- **VET 774** Vetro Pirex per 774 - Glass Pirex for 774 - Verre Pirex pour 774 - Pyrex Glas für 774
- **VET 604** Vetro Pirex per 604 - Glass Pirex for 604 - Verre Pirex pour 604 - Pyrex Glas für 604
- **VET 973** Vetro Pirex per 973 - Glass Pirex for 973 - Verre Pirex pour 973 - Pyrex Glas für 973
- **915 bi** Paralume tessuto bianco - Lampshade white fabric - Abat-jour tissu blanc - Lampenschirm aus weißem Stoff
- **915 ne** Paralume tessuto nero - Lampshade black fabric - Abat-jour tissu noir - Lampenschirm aus schwarzem Stoff
- **TRASF** Trasformatore / transformer / transformateur / transformator /
- **LAMPG9LED** Lampada / bulb / ampoule / lamp LED G9 30W 3000K 250 Lumen

ESPOSITORI

EXHIBITORS / EXPOSANTS / AUSSTELLUNGSSTÄNDER / НАПОЛЬНЫЙ

**EXPO 15**

Pannello espositore con presentazione fotografica

Displayboard with picture

Presentoir avec photo

Ausstellungspaneel mit Fotopräsentation

Выставочная панель с презентацией фотографий

cm 40 L x 70 H



EXPO 17
 Pannello espositore con presentazione fotografica
 Displayboard with picture
 Présentoir avec photo
 Ausstellungspaneel mit Fotopräsentation
 Выставочная панель с презентацией фотографий
 cm 60 L x 20 H



EXPO 9



EXPO 1



EXPO 9
 Espositore per oggettistica con anta in vetro e serratura
 Display board for freestanding articles with glass door and lock
 Présentoir pour objets à poser avec guichet en verre et fermeture
 Ausstellungsständer für Zubehör mit Glasstür und Schloss
 Напольный стенд с замком для настольных предметов
 cm 29 L x 20 P x 160 H

EXPO 1
 Pannello espositore su ruote
 Display board on wheels
 Présentoir sur des roues
 Ausstellungsstand auf Rollen
 Напольный стенд на колесах
 cm 60 L x 42 P x 210 H

CONDIZIONI DI VENDITA

ORDINATIVI - Gli ordini incompleti o privi di informazioni che non ne permettano una corretta esecuzione, possono subire ritardi di registrazione. Ogni ordine, comunque conferito, con un imponibile netto, superiore a € 750,00 + IVA, sarà valido se accettato mediante conferma d'ordine.

CONSEGNE - Le date di consegna dovranno considerarsi indicative e fatto salvo causa di forza maggiore ed in nessun caso possono costituire pretesto per i ritardi di pagamento o risarcimento dei danni: gli ordini possono essere evasi anche parzialmente.

GARANZIA - La STILHAUS riconosce una garanzia di 5 ANNI su i propri prodotti contrassegnati sul catalogo e con apposito tagliando nella confezione. La garanzia comporta per STILHAUS unicamente l'obbligo di provvedere alla sostituzione dei prodotti riconosciuti difettosi con l'esclusione di ogni altra prestazione così come le spese di trasporto, l'indennizzo o risarcimento per danni diretti o indiretti.

RAEE -  Iscr. Al Registro A.E.E. n. IT 311000008191, i prezzi delle illuminazioni non comprendono il contributo.

RESI - La merce viaggia a rischio e pericolo del committente ai sensi dell'art. 1510 del codice civile. Il destinatario è tenuto a controllare la merce in arrivo e contestare eventuali danni direttamente al vettore anche quando la merce è recapitata in porto franco e comunque inviare entro 24 ore dal ricevimento un fax informativo, con i riferimenti della relativa fattura d'acquisto, preso la nostra sede.

Non si accettano resi di merce se non espressamente autorizzati per iscritto e comunque franchi di ogni spesa al magazzino della nostra sede. I resi causati da errori di trasmissione dell'ordine da parte del cliente verranno accreditati all'80% del prezzo netto di vendita.

RECLAMI - Per qualsiasi reclamo o controversia, il foro competente sarà quello di Viterbo.

CONDIZIONI DI PAGAMENTO - Il mancato rispetto dei termini di pagamento, comporta l'addebito degli interessi al tasso prime-rate ABI maggiorato di 3 punti a far data dall'emissione della fattura + € 15,00 per recupero spese. E' facoltà della ditta sospendere le consegne di clienti inadempienti. L'azienda si riserva la proprietà delle merci non ancora pagate.

TOLLERANZE - Le illustrazioni dei nostri prodotti, deplianti e cataloghi, non costituiscono impegno di fedele riproduzione, la ditta si riserva il diritto di apportare modifiche ai propri prodotti senza l'obbligo di preavviso.

CONTRASSEGNO - Le spedizioni di importo totale inferiore a € 150,00 saranno effettuate in contrassegno.

TRASPORTI - Il trasporto è franco per importi di imponibile superiore ad e 200,00, in caso contrario si provvederà al recupero in fattura di € 15,00.

Per ISOLE:

- Per importi di imponibile inferiore ad € 400,00 il contributo per il trasporto è pari ad € 18,00;
- per importi tra € 400,00 e € 1.200,00 il recupero in fattura è pari al 4 % dell'imponibile;
- per importi superiori a € 1.200,00 il trasporto è franco.

IMBALLI - Per spedizioni di materiali con pallet si provvederà al recupero in fattura di € 10,00.

IMBALLI PER SPEDIZIONI SPECCHI - Per spedizioni si provvederà al recupero in fattura di: € 5,00 netti a specchio per misure fino cm150,
€ 10,00 netti a specchio per misure superiori cm 150

FORNITURE - Per forniture personalizzate e grandi volumi le condizioni di vendita e di trasporto verranno stabilite su preventivo.

**LE PRESENTI CONDIZIONI DI VENDITA SI INTENDONO ACCETTATE CON L'ORDINE
CONDIZIONI VALIDE SOLO PER IL MERCATO ITALIANO**

*Terms of sale FOR EXPORT / Conditions de vente POUR L'EXPORTATION
Verkaufsbedingungen GILT FÜR AUSLÄNDISCHE / условия продажи*



ORDERS - All orders must be accepted by STILHAUS srl, no order can be cancelled without the written consent of the STILHAUS srl. Cancelled orders are subject to payment cancellation charges to cover all costs incurred by the company up to date of cancellation. Orders can be delivered partially too.

PRICES - The price-list does not include VAT, and prices can change without notice. All goods are sold ex works STILHAUS's factory.

DELIVERY - The delivery time starts from the date of the order-confirmation. The goods travel at buyer's risk even if sold free of carriage, the consignee must check the goods on their arrival and claim immediately eventual damages directly to the carrier who is the responsible. Any complaint must be presented in written form within 24 hours from receipt of the goods: otherwise STILHAUS SRL will not acknowledge any compensation for damages or assessed breakages.

RAE - Iscr. Register to A.E.E. n. 311000008191 IT, prices do not include the contribution of the illuminations

PAYMENT TERMS - Payments must be done according to the terms agreed upon and indicated on our order confirmation; in case of delayed payments STILHAUS reserves itself the right to debit the purchaser with the applicable interests. The supplied products remain property of STILHAUS srl up to complete payment of the price.

RETURNS - Returned goods are not accepted if not agreed previously with STILHAUS by written authorization. Damage caused by an improper installation or wrong use are not covered by any guarantee.

LAW COURT - For any controversy the Court of Viterbo is the only competent authority.

In order to improve its products, STILHAUS reserves itself the right to modify the technical data, aesthetic and dimensional peculiarities without notice.

ALL THE ABOVE MENTIONED CONDITIONS ARE CONSIDERED AS FULLY ACCEPTED WHEN PLACING THE ORDER

COMMANDES - Toutes les commandes sont sujettes à l'approbation de STILHAUS srl. Aucune commande ne peut être annulée sans préalable approbation de STILHAUS srl, qui se réserve en tous cas le droit de débiter éventuels coûts soutenus jusqu'à la date de l'annulation. Les commandes peuvent être livrées partiellement.

PRIX - Nos marchandises sont facturées sur la base des tarifs en vigueur au jour de la livraison et peuvent varier sans précision. Le tarif ne comprend pas de TVA et la marchandise est vendue départ usine STILHAUS.

LIVRAISON - Le délai de livraison commencent à partir de la date de confirmation de l'a commande et sont toujours indicatifs. Le transfert du risque s'effectue vers l'acheteur au moment de l'expédition, même en cas de livraison franco. Le destinataire est obligé de vérifier les marchandises arrivées et de réclamer les éventuels dommages immédiatement directement au transporteur qui en est le responsable. En ce qui concerne la conformité, la quantité et la qualité apparente de la marchandise livrée par rapport à celle commandée, l'acheteur doit nous adresser ses réclamations éventuelles par écrit au plus tard dans un délai de 24 HEURES après réception. Au delà les réclamations ne sont plus recevables.

RAEE - Iscr. Inscrivez-vous pour A.E.E. n. 311000008191 IT, prix ne comprennent pas la contribution des illuminations

PAIEMENT - Les termes de paiement ne peuvent pas être retardés pour quelque cause que ce soit, même en cas de litige. Dans le cas de paiement retardé STILHAUS se réserve le droit de débiter à l'acheteur les intérêts applicables. Les produits fournis restent propriété de STILHAUS srl jusqu'au paiement complet du prix.

GARANTIE - Notre garantie couvre tous défauts de fabrication à condition que notre produit ait été installé conformément à nos instructions de montage et aux règles de l'art. Notre garantie est limitée à la remise en état ou remplacement de la pièce reconnue défectueuse. La garantie ne couvre, en aucun cas, les frets de main d'oeuvre, des frais de déplacement, choc, utilisation de produits de nettoyage corrosifs ou abrasifs.

RETOURS - Aucun retour de marchandise ne peut-être effectué sans notre accord écrit.

CARACTÉRISTIQUES DU PRODUIT - Pour améliorer ses produits, STILHAUS se réserve le droit de modifier les données techniques, esthétique caractéristiques et dimensionnels sans avis.

CONTESTATIONS - En cas de contestation, le Tribunal de Viterbo est la seule juridiction reconnue et acceptée de part et d'autre.

TOUTES LES CONDITIONS SURMENTIONNÉES SONT CONSIDÉRÉES COMPLÈTEMENT ACCEPTÉES EN PASSANT LA COMMANDE

AUFTRÄGE - Alle Aufträge müssen von der STILHAUS srl bestätigt werden. Kein Auftrag kann ohne die schriftliche Zustimmung von STILHAUS srl annulliert werden. Die Kosten der Annullierung des Auftrags müssen vom Kunden getragen werden. Die Aufträge können partiell verändert werden.

PREISE - Die Preise beinhalten nicht die Mehrwertsteuer und können ohne Vorankündigung verändert werden. Alle Waren werden frei Fabrikhallen bereitgestellt.

LIEFERBESTIMMUNGEN - Die Lieferzeit beginnt mit dem Datum der Auftragsbestätigung. Die Waren werden nach Auftrag und zu Lasten des Käufers versandt. Der Käufer muss die Waren bei der Ankunft kontrollieren und eventuelle Schäden unverzüglich der betrauten Spedition melden. Was die Auftragskonformität, Qualität und Menge der gelieferten Waren betrifft, so muß der Käufer eventuelle Unstimmigkeiten innerhalb von 24 Stunden nach der Lieferung melden. Außerhalb der Fristen werden Reklamationen nicht akzeptiert.

RAEE - Iscr. Registrieren A.E.E. n. 311000008191 IT, Preise enthalten keine Leuchtmittel

ZAHLUNGSMODALITÄTEN - Die Zahlung muss nach den Bestimmungen erfolgen die auf der Auftragsbestätigung vereinbart wurden. Im Falle einer verspäteten Zahlung, behält sich Stilhaus das Recht vor dem Käufer die Zinsen in Rechnung zu stellen. Die gelieferten Waren bleiben bis zur vollständigen Bezahlung Eigentum von STILHAUS srl.

RÜCKGABE - Durch nicht sachgemäße Installation und Gebrauch verursachte Schäden werden nicht von der Garantie gedeckt.

BESCHWERDE - Beschwerde- Gerichtsort ist Viterbo.

TOLLERANZEN - Mit dem Ziel die Produkte zu verbessern, behält sich Stilhaus vor, Veränderungen an den eigenen Produkten ohne Vorankündigung durchzuführen.

ALLE OBEN GENANNTEN BEDINGUNGEN GELTEN MIT DER ANNAHME DES AUFTRAGS ALS ANGENOMMEN

Заказы – все заказы должны быть приняты фабрикой Stil Haus, заказ не может быть аннулирован без письменного оповещения фабрикой. Отмененные заказы подлежат возврату денежных средств. Заказы также могут быть доставлены частично.

Цены – Прайс-лист не включает НДС, и цены в счете могут быть другими. Все товары вывозятся с фабрики самостоятельно.

Поставки – Срок поставки начинается с момента подтверждения заказа. Все риски ложатся на покупателя. Все претензии рассматриваются в письменной форме в течении 24 часов после получения товара. В противном случае фабрика Stil Haus не несет ответственности за возмещение поврежденного груза.

RAEE - ISCR. Зарегистрируйся, чтобы A.E.E. n. 311000008191 IT, Цены не включают вклад иллюминации

Условия оплаты – оплата может быть произведена в соответствии с выставленным счетом. В случае задержки оплаты, фабрика оставляет за собой право не отгружать неоплаченный товар до момента погашения полной стоимости товара.

Возврат товара – Возврат товара не принимается если он не был согласован ранее письменно с фабрикой.

Гарантия не распространяется при неправильной установке, при неправильном использовании.

Единственным органом – способным разрешить спорные ситуации, является суд Витербо. С целью улучшения продуктов STILHAUS оставляет за собой право изменять технические характеристики, габариты и внешний вид изделий без предварительного уведомления.

ВСЕМИ ВЫШЕПЕРЕЧИСЛЕННЫМИ УСЛОВИЯМИ СЧИТАЮТСЯ КОГДА ВЫ СОГЛАСНЫ ПОДТВЕРДИТЬ ЗАКАЗ.

TABELLA COLORI

COLOUR CHART / TABLEAU COULEURS / FARBENTABELLE / ДИАГРАММА ЦВЕТА

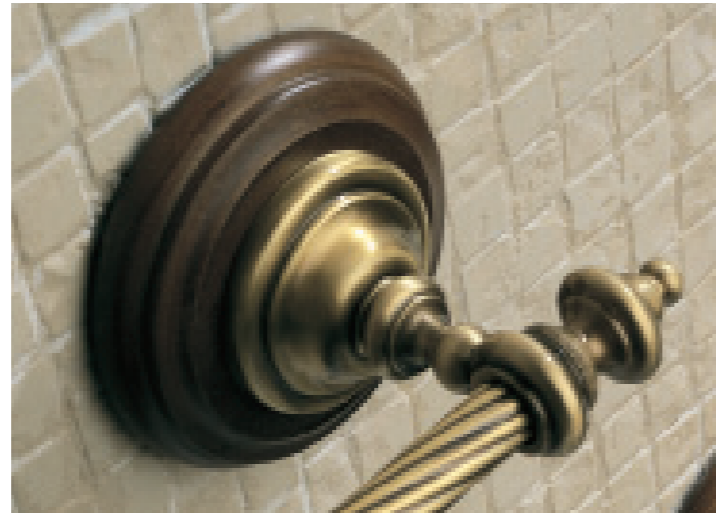

La cromatura viene effettuata su particolari che vengono sottoposti ai seguenti trattamenti:

Pulimentatura, sgrassatura chimica con ultrasuoni, sgrassatura elettrolitica, nichelatura lucida livellante con uno spessore medio di 18-20 micron; cromatura con spessore medio di 0,3 micron. Cromature conformi ai test di salinità secondo la norma UNI ISO 9227 NSS.

La doratura viene eseguita con oro 24 karati con spessore medio di 0,04 micron e verniciatura trasparente con cottura a forno a 180°C.

La verniciatura antico toscano viene effettuata su particolari che vengono sottoposti ai seguenti trattamenti:

Sabbatura, due mani di fondo, decorazione a mano, e verniciatura trasparente con cottura a forno a 180°C.

The chrome-plating is effected on component that are treated with the following processes: Polishing, chemical ultrasonic cleaning, electrolytic degreasing, shiny nickel-plating with an average thickness of 18-20 microns; chromium plating with average thickness of 0,3 microns. Salinity test UNI ISO 9227 NSS is carried out.

The gilding is performed with gold 24 karats with average thickness of 0,04 microns coated by a transparent painting in oven cooking at 180°C.

The ancient Tuscan painting is made on parts

that are treated with the following processes: sand bath, two ground coats, hand decoration and transparent painting in oven cooking at 180°C.

Le chromage est effectué sur des parties qui

subissent les suivants traitements:

Polissage, dégraissage chimique par Ultrasons, dégraissage électrolytique, nickelage brillant avec une épaisseur moyenne de 18-20 Microns; chromage avec épaisseur moyenne de 0,3 microns. Test de salinité UNI ISO 9227 NSS effectué. La dorure est réalisée en or 24 Carates avec épaisseur moyenne de 0,04 microns et couverte par une peinture transparente cuite au four à 180°C.

La peinture ancien toscano est réalisée sur des parties qui sont soumises aux suivants traitements: sablage, deux mains de fond, décoration à la main couverte par une peinture transparente cuite au four à 180°C.

Die Verchromungen werden auf Einzelteilen angebracht die folgenden Verfahren unterzogen werden:

Säuberung, chemische Entfettung mit Ultraschall, elektrolytische Entfettung, Vernickelung mit einer Stärke von ca. 18-20 Mikron. Verchromung mit einer Stärke von ca. 0,3 Mikron. Verchromung entspricht der Norm UNI ISO 9227 NSS.

Die Vergoldung wird mit 24 karätigem Gold in einer durchschnittlichen Stärke von 0,04 Mikron ausgeführt und mit einer transparenten Beschichtung bei 180 Grad im Ofen gebrannt.

Die Farbe "Toskanisches Antik" wird auf Einzel-

teilen angebracht die folgenden Verfahren unterzogen werden:

Sandstrahlung, 2 Lagen Grundierung, Verzierung per Hand und transparente Beschichtung bei 180 Grad im Ofen gebrannt.

Хромирование осуществляется на детали, которые проходят следующие процедуры:

Полировка, обезжиривание и технология ультразвуковой очистки, глянцевое никелирование средней толщиной 18-20 мкм, хромирование толщиной в 0,3 мкм. Хромирование используется в соответствии со стандартом UNI ISO 9227 NSS

Золочение осуществляется 24 каратами средней толщиной 0,04 мкм и прозрачным покрытием при температуре 180° с. Тосканская живопись производится при следующих условиях:

Пескоструйная обработка, два слоя грунтовки, ручная отделка, и прозрачным покрытием при температуре 180° с

FINITURE DISPONIBILI / AVAILABLE FINISHINGS / FINISSAGES DISPONIBLES / VERFÜGBARE OBERFLÄCHEN / ВАРИАНТЫ ОТДЕЛОК

02 CROMO - ORO <i>Chrome - Gold / Chrome - Or / Chrom - Gold / Хром - золото</i>	OMEGA / ELITE / GIUNONE / SMART
03 BIANCO - CROMO <i>White - Chrome / Blanche - Chrome / Weiß - Chrom / Белый - хром</i>	GIUNONE / LIVING
04 BIANCO - ORO <i>White - Gold / Blanche - Or / Weiß - Gold / Белый - золото</i>	GIUNONE
05 NERO - CROMO <i>Black - Chrome / Noir - Chrome / SchwarzChrom / черный - Хром</i>	LIVING
08 CROMO <i>Chrome / Chrome / Chrom / Хром</i>	FLUID / ARIA / ZEFIRO / QUID / URANIA / DIANA / MEDEA / VENUS / GEA / LIVING BUCKET / DIVA / MARTE / PRISMA / SMART / SMART LIGHT / ELITE GIUNONE / IDRA / NEMI / NOTO / NOTO LIGHT / MARTE / MIZAR / OPERA
09 OTTONE NATURALE <i>Natural Brass / Laiton naturel / Natürliches Messing / Натуральная латунь</i>	FLUID
12 NICHEL LUCIDO <i>Polish nickel / Nikel poli / Nikel poliert / Глянцевый никель</i>	IDRA / FLUID
16 ORO <i>Gold / Or / Gold / Золото</i>	ELITE / GIUNONE / SMART LIGHT / NOTO / NOTO LIGHT / MARTE / GEA / OPERA
24 BIANCO OPACO <i>White Matt / Blanc opaque / Weiß / белый матовый</i>	HASHI
23 NERO OPACO <i>Black Matt / Noir / Scharz / черный матовый</i>	URANIA / KREA / HASHI / MEDEA
25 BRONZO <i>Bronze / Bronze / Bronze / Бронза</i>	PRISMA / ELITE / GIUNONE / SMART / SMART LIGHT / IDRA / MARTE
26 RAME <i>Copper / Cuivre / Kupfer / Медь</i>	ELITE / GIUNONE / IDRA
32 BIANCO "ANTICO TOSCANO" <i>"Tuscany Ancient" white / Blanc "Ancien Toscan" / "Toskanisches Antik" weiß / белая тосканская античность</i>	FLORA
33 CROMO - LEGNO NOCE <i>Chrome - Dark walnut wood / Chrome - bois noiser / Chrom - Nußbraun dunkel / белый - дерево орех</i>	GIUNONE / NEMI
34 ORO - LEGNO NOCE <i>Gold - Dark walnut wood / Or - Bois noiser / Gold - Nußbraun dunkel / золото - дерево орех</i>	GIUNONE
35 BRONZO - LEGNO NOCE <i>Bronze - Dark walnut wood / Bronze - Bois noiser / Bronze - Nußbraun dunkel / бронза - дерево орех</i>	GIUNONE
36 NICHEL SATINATO <i>Satin nickel / Nickel satiné / Nickel matt / Никель сатин</i>	DIANA / URANIA / MEDEA / ELITE / GIUNONE / PRISMA
39 CROMO - CERAMICA BIANCA <i>Chrome - white pottery / Chromé blanche céramique / Chrom Weiße Keramik / хром - белая керамика</i>	NEMI
40 CROMO - CERAMICA DECORATA <i>Chrome - decorated pottery / Chromé - médaillée céramique / Chrom - dekorierte Keramik / хром - керамика декорированная</i>	NEMI
43 NERO / ALLUMINIO ANTICO TOSCANO <i>T.A. black/aluminium / Noir/aluminium A.T. / T.A. schwarz/Aluminium / черная тосканская античность</i>	FLORA
51 BRONZO ANTICO <i>Ancient bronze / Bronze ancien / Antik Messing / античная бронза</i>	FLORA
54 ACCIAIO SATINATO <i>Satin steel / Acier satiné / Stahl satiniert / сатирированная сталь</i>	SATURNO / KREA
55 ACCIAIO LUCIDO <i>Satin steel / Acier satiné / Stahl satiniert / Полированная сталь</i>	KREA

È vietata la riproduzione totale o parziale di foto e illustrazioni contenute in questo catalogo.
Partial total or of contained photos and illustrations in this catalogue is prohibited the reproduction.
Elle est défendue la reproduction totale ou partiel de photos et d'illustrations contenues dans ce je catalogue.
Запрещается полное или частичное воспроизведение фотографии и иллюстрации, содержащиеся в этом каталоге.



www.stilhaus.it



Stilhaus Arredo Bagno srl

Via della chimica, n°4 - 01100 Viterbo Italy
Tel. +39/0761.352736 r.a. - Fax +39/0761.251163
www.stilhaus.it - e-mail: stilhaus@stilhaus.it

PHOTO: Fotostudio Mauro Mattioli - Viterbo
GRAFICA: Fotostudio Mauro Mattioli - Viterbo
PRINTING: ArtiGraficheCelori - Terni

Si ringrazia:
Effepi Rubinetterie SRL - Webert rubinetterie SRL - Emmevi rubinetterie SRL
Bianchi rubinetterie SNC - Scarabeo ceramiche srl

Finito di stampare nel mese di Gennaio 2018

NECESSARI PER IL BAGNO

www.stilhaus.it